

## Lago



**D** Montageanleitung

**GB** Assembly instructions

**FR** Notice de montage

**NL** Handleiding voor de montage

**CZ** Montážní návod

**IT** Istruzioni di montaggio

**RO** Instrucțiuni de montaj

**RU** инструкция по сборке

**PL** Instrukcja montażu

**SK** Návod na montáž

**HU** Szerelési útmutató

**TR** Montaj talimati

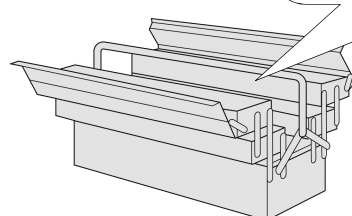
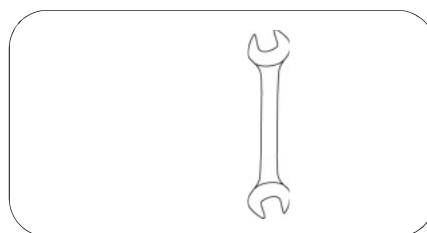
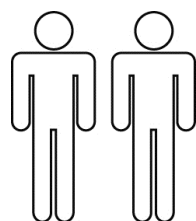
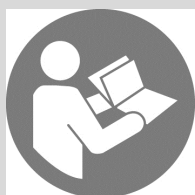

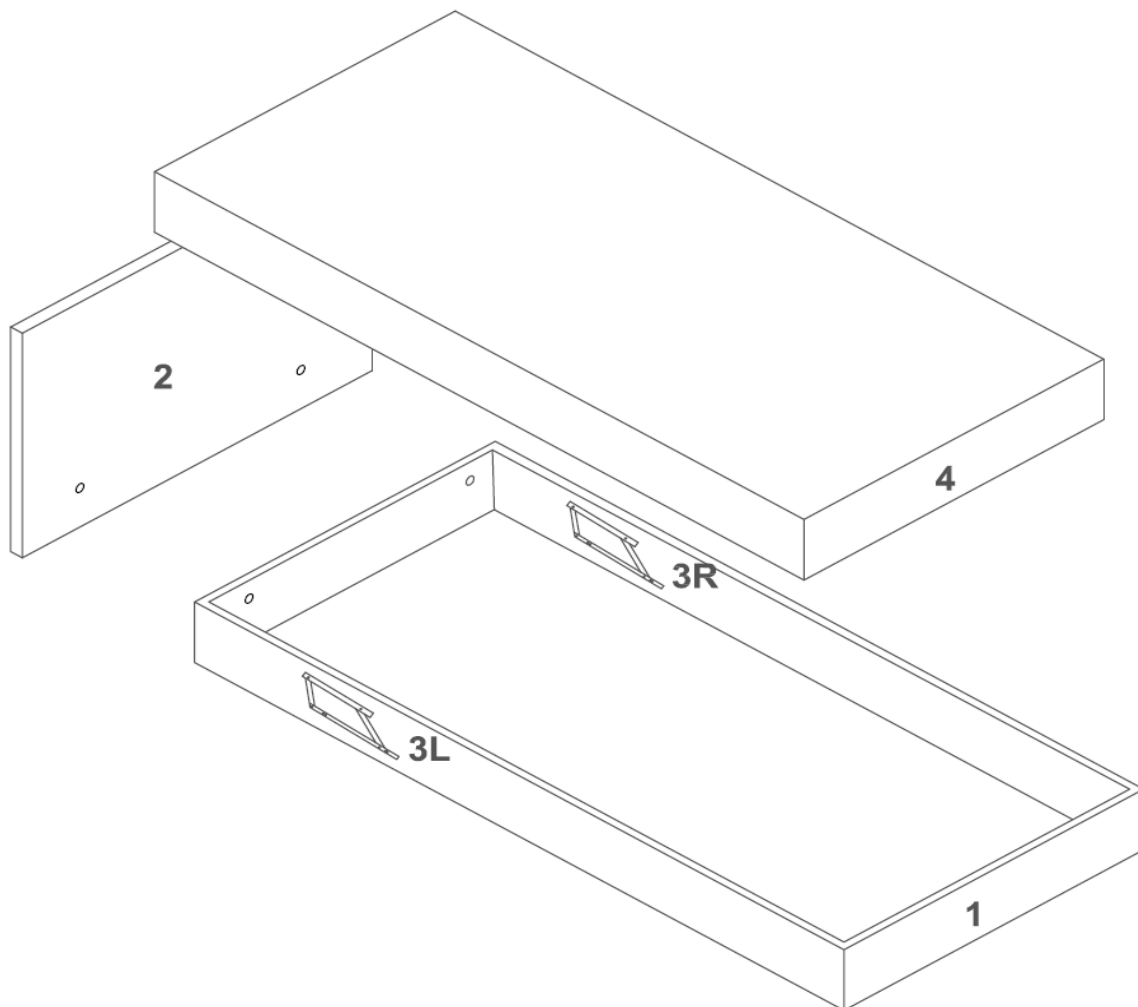

0  
10  
20  
30  
40  
50  
60  
70  
80  
90  
100  
110  
120  
130  
140  
150  
160  
170  
180  
190  
200

<b>Service • Assistenza • Dienstverlening • Serwis</b> <b>Servis • Szerviz • Сервисная служба</b>		
Name • Nom • Nome • Naam Nazwa • Jméno • Názov • Név Denumire • İsim • Название	<b>Lago EB</b>	
Nr. • No. • N° • Номер • Č • Sz	<b>SH42</b>	
Typ • Type • Tip • Típus • Тіро Тип	<b>FEPO</b>	



A	B	C
2x 8x50	2x M8	2x M8

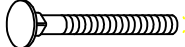

A		B		C		2x 8x50	2x M8	2x M8
---	---	---	---	---	---	---------	-------	-------

