

- (D) Montageanleitung
- (GB) Assembly instructions

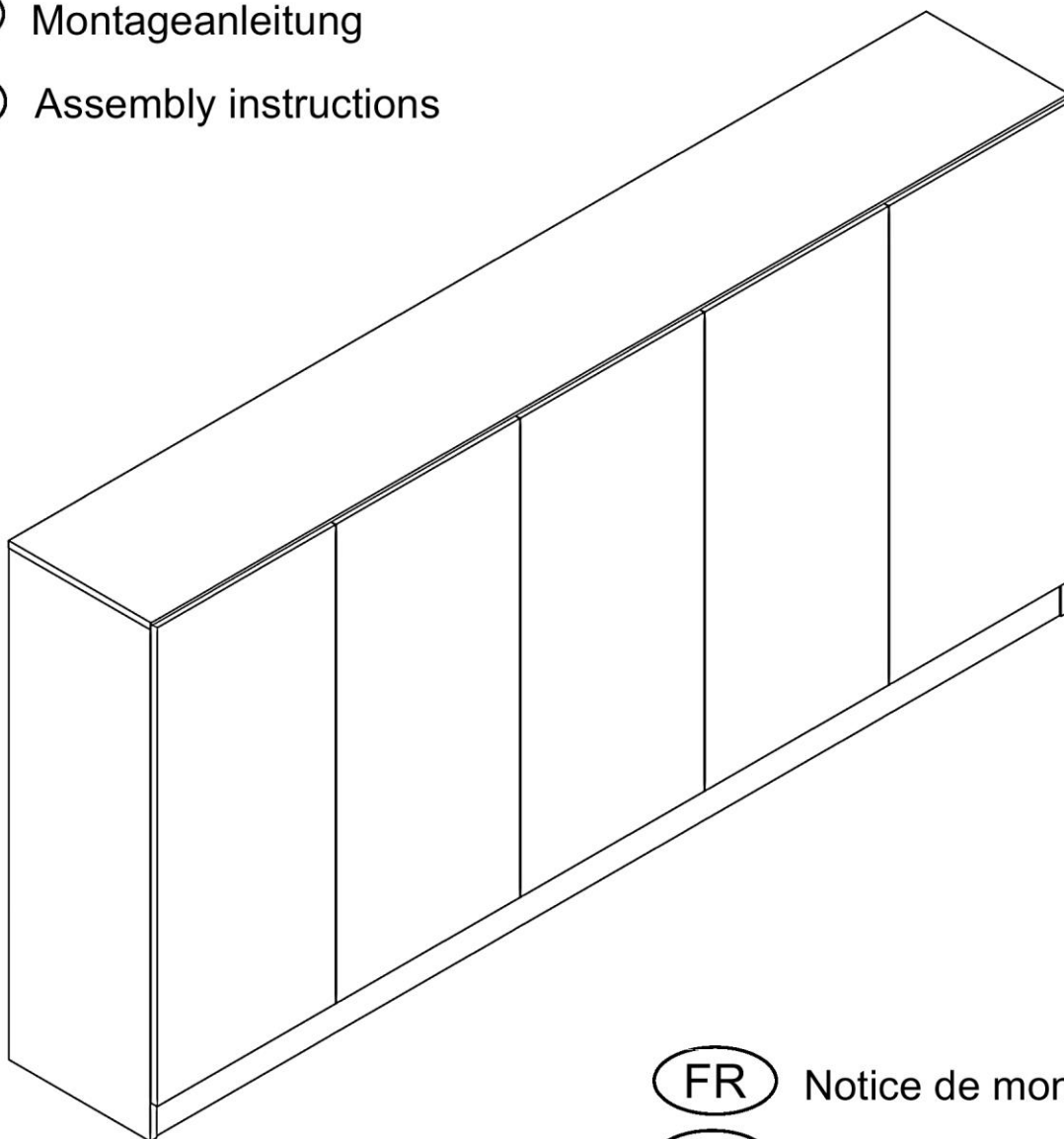

- (HU) Szerelési útmutató
- (NL) Handleiding voor de montage
- (PL) Instrukcja montażu
- (RO) Instrucțiuni de montaj

- (FR) Notice de montage
- (RU) Инструкция по монтажу
- (TR) Montaj talimati
- (IT) Istruzioni di montaggio
- (SK) Návod na montáž
- (CZ) Montážní návod

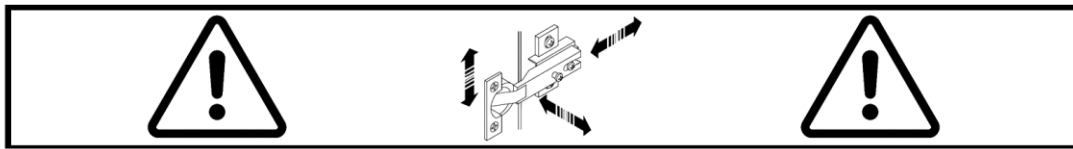

(D) Nach der Montage sind die Spaltmaße der Türen nicht eingestellt. Siehe letzte Seite!

(GB) After installation, the gap dimensions of the doors are not adjusted. See last page!

(FR) Après l'installation, les dimensions de l'espace entre les portes ne sont pas ajustées. Voir dernière page !

(IT) Dopo l'installazione le dimensioni della fessura delle ante non vengono modificate. Vedi l'ultima pagina!

(NL) Na montage worden de spleetmaten van de deuren niet aangepast. Zie laatste pagina!

(PL) Po montażu wymiary szczeliny drzwi nie są regulowane. Zobacz ostatnią stronę!

(CZ) Po montáži se rozměry mezery dveří neupravují. Viz poslední strana!

(RO) După instalare, dimensiunile golului ușilor nu sunt ajustate. Vezi ultima pagina!

(HU) A beépítés után az ajtók résméretei nem kerülnek beállításra. Lásd az utolsó oldalt!

(SK) Po montáži sa rozmery medzery dverí neupravujú. Pozri poslednú stranu!

(TR) Montaj sonrasında kapıların aralık ölçüleri ayarlanmaz. Son sayfaya bakın!

(RU) После установки размеры зазора дверей не корректируются. Смотрите последнюю страницу!

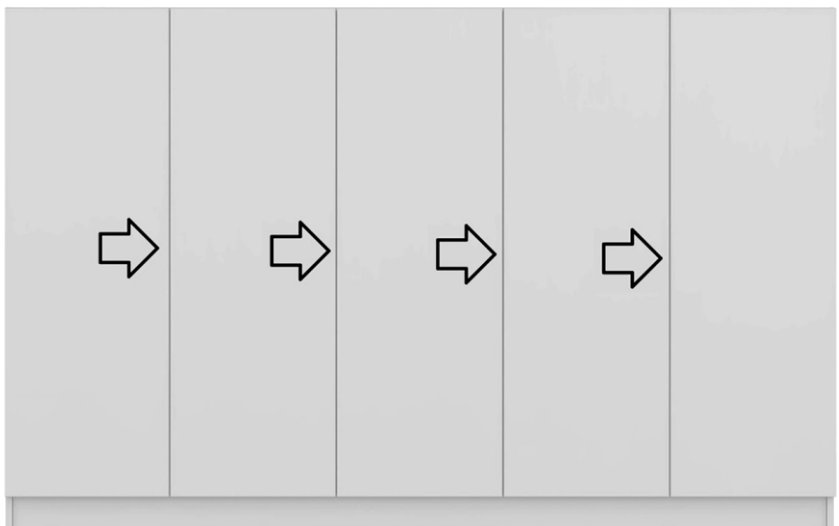
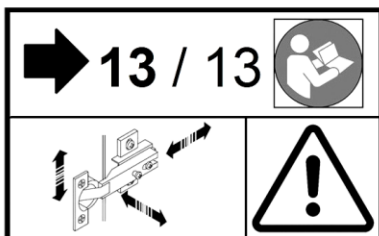
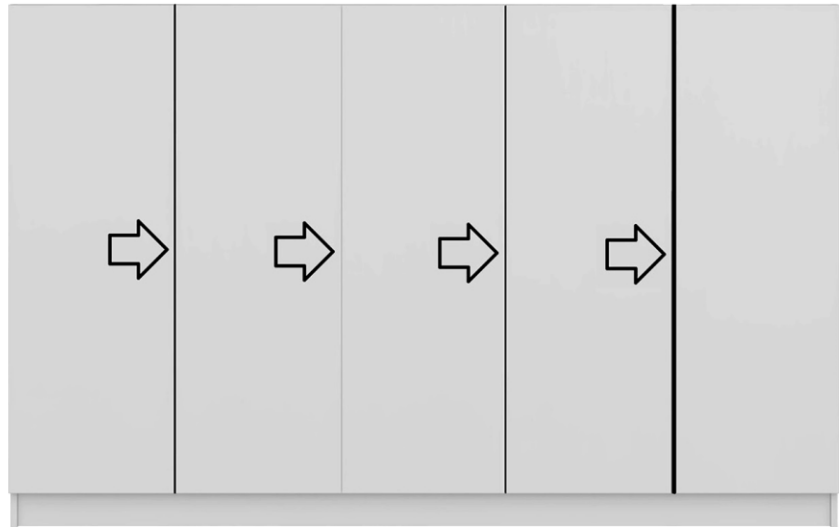

Service • Asststenza • Dienstverlening • Serwis Servis • Szerviz • Сервисная служба

Name • Nom • Nome • Naam •
Nazwa • Jméno • Názow • Név •
Denumire • Isim • Название

Nr. • No. • N° • Номер • Č • Sz

Typ • Type • Tip • Típus • Tipo •
Тип

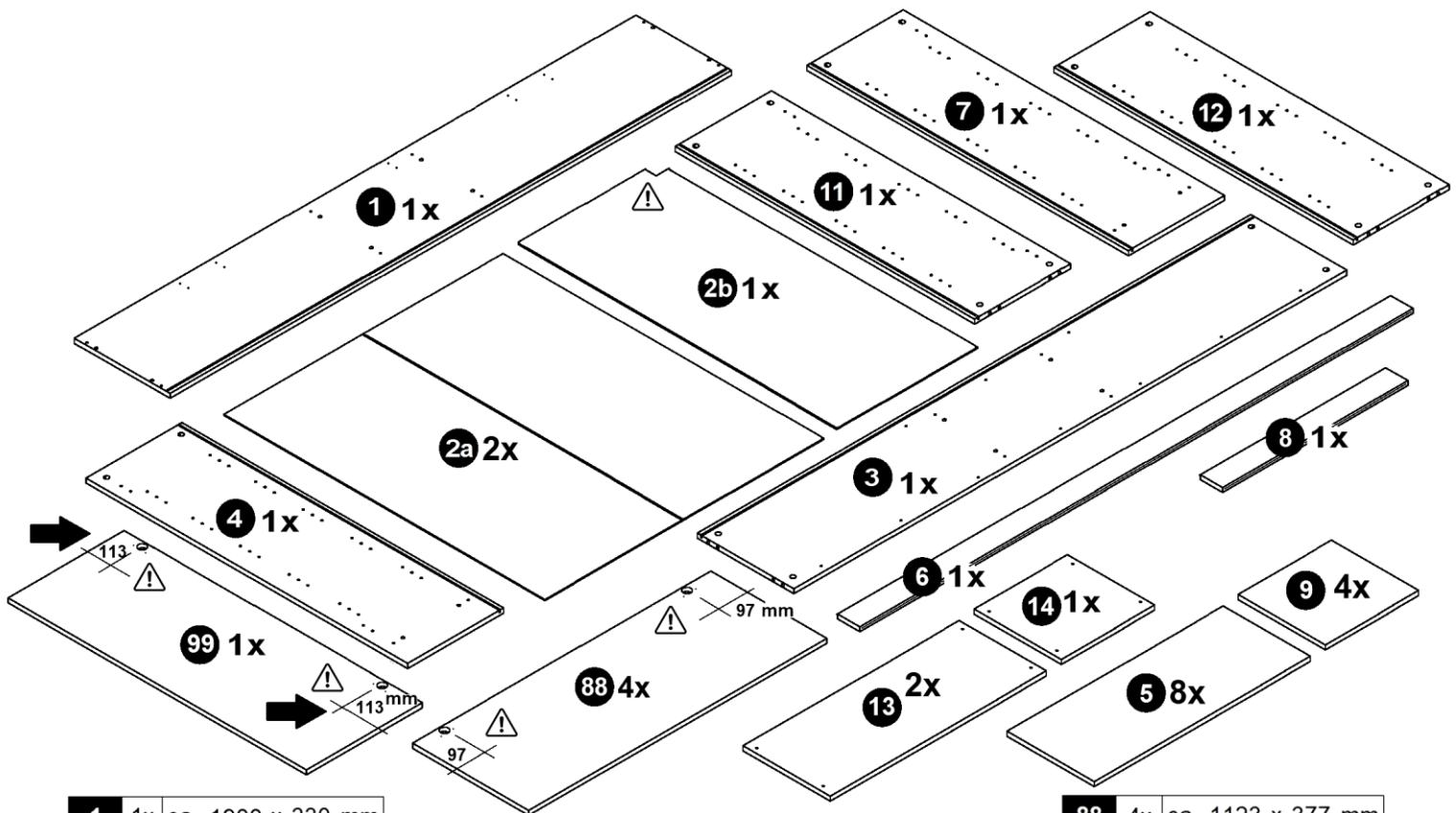
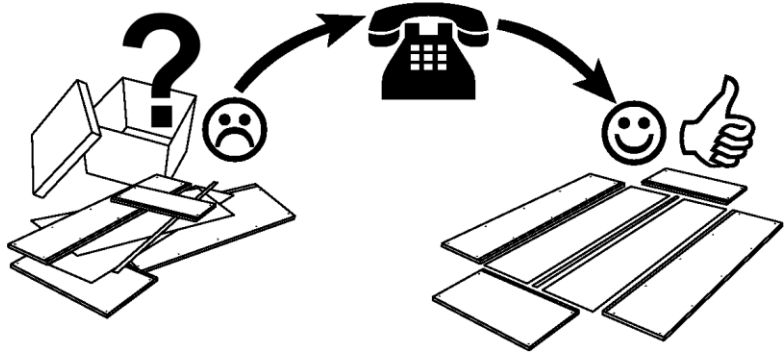
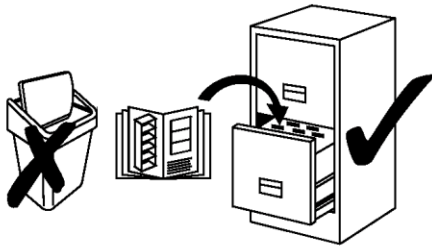

1 1x ca. 1900 x 330 mm

2a 2x ca. 1105 x 747 mm

2b 1x ca. 1105 x 372 mm

3 1x ca. 1869 x 330 mm

4 1x ca. 1185 x 330 mm

5 8x ca. 737 x 300 mm

6 1x ca. 1869 x 77 mm

7 1x ca. 1185 x 330 mm

8 1x ca. 700 x 77 mm

9 4x ca. 365 x 300 mm

88 4x ca. 1123 x 377 mm

99 1x ca. 1123 x 377 mm

11 1x ca. 1093 x 330 mm

12 1x ca. 1093 x 330 mm

13 2x ca. 737 x 300 mm

14 1x ca. 365 x 300 mm

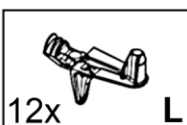
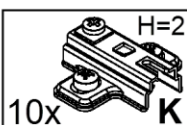
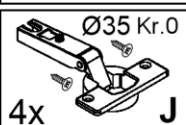
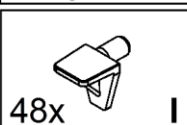
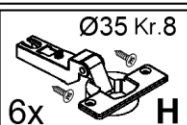
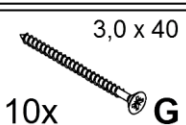
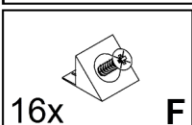
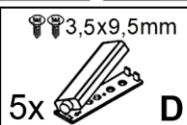
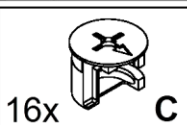
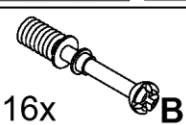
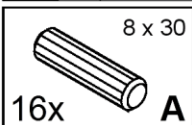

1

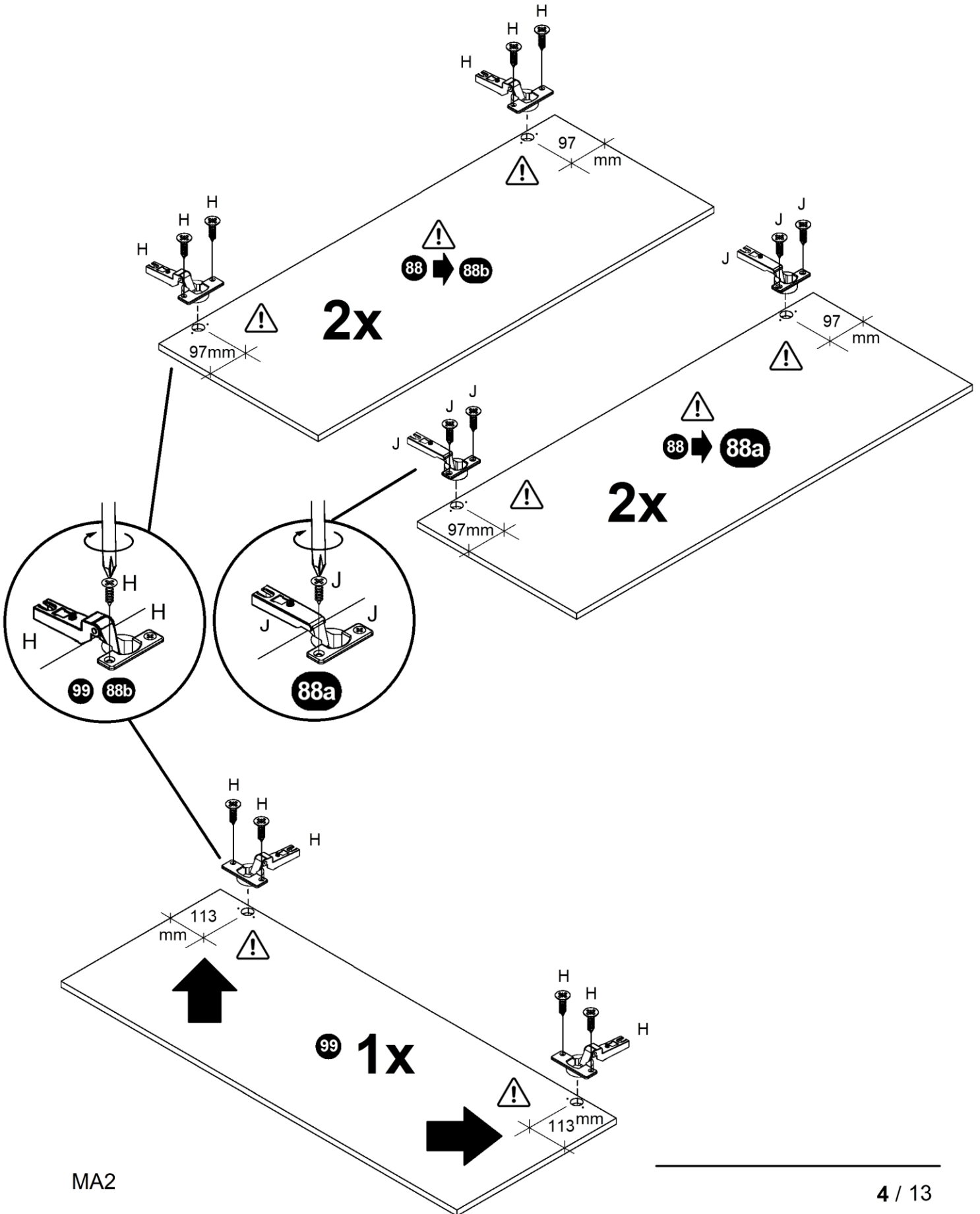
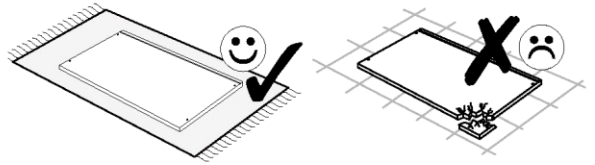
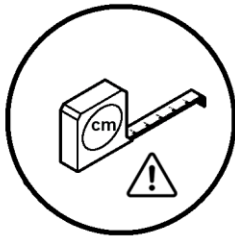
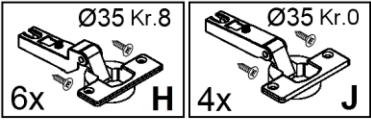

2

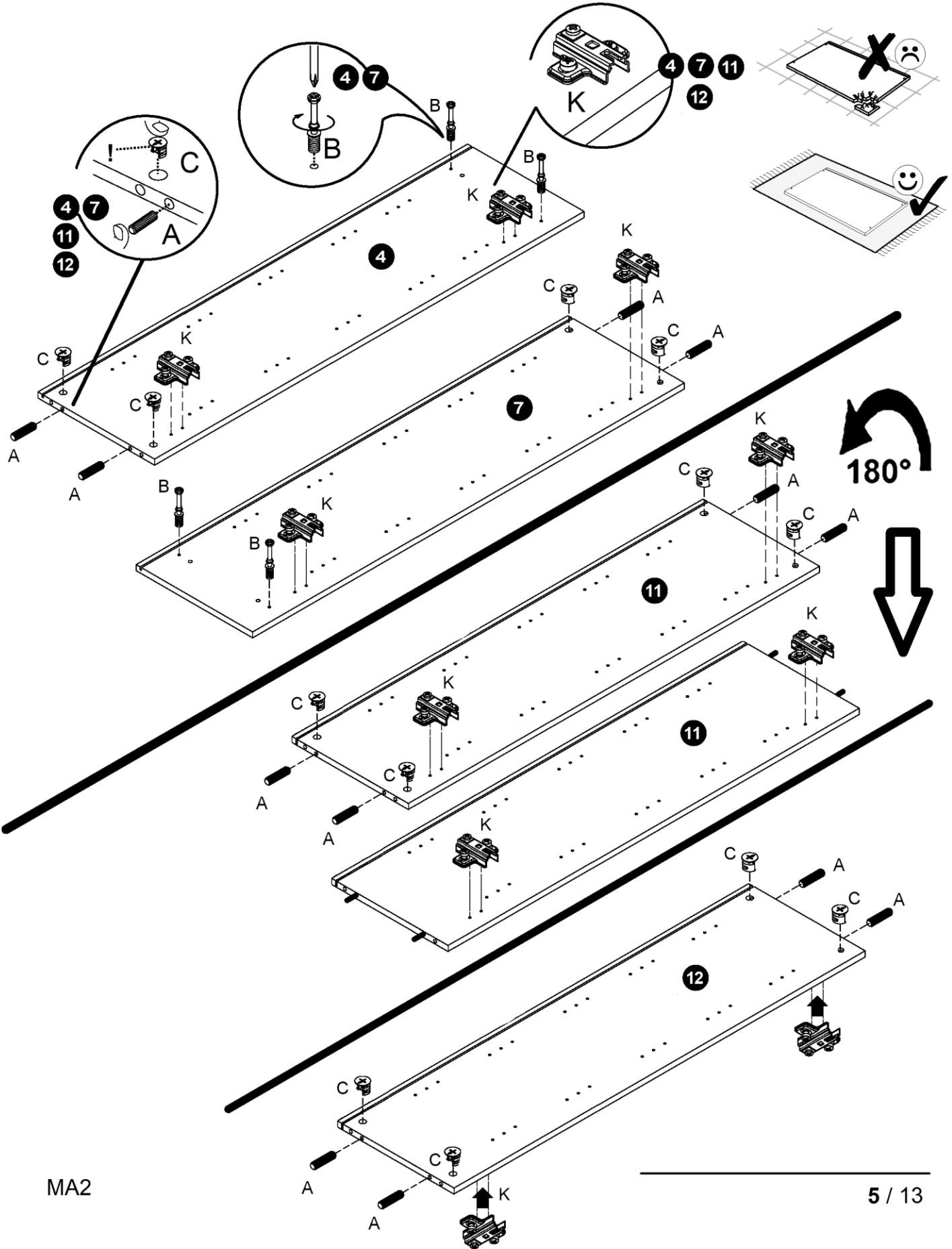
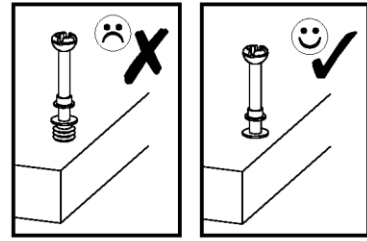
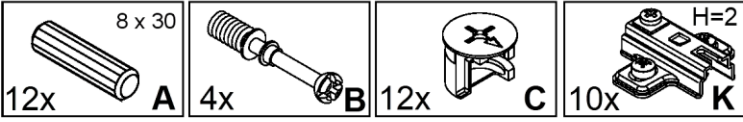

3

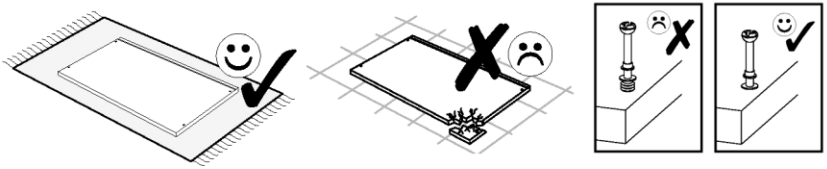

- 8 x 30
4x **A**
- 12x **B**
- 4x **C**
- 5x **D**

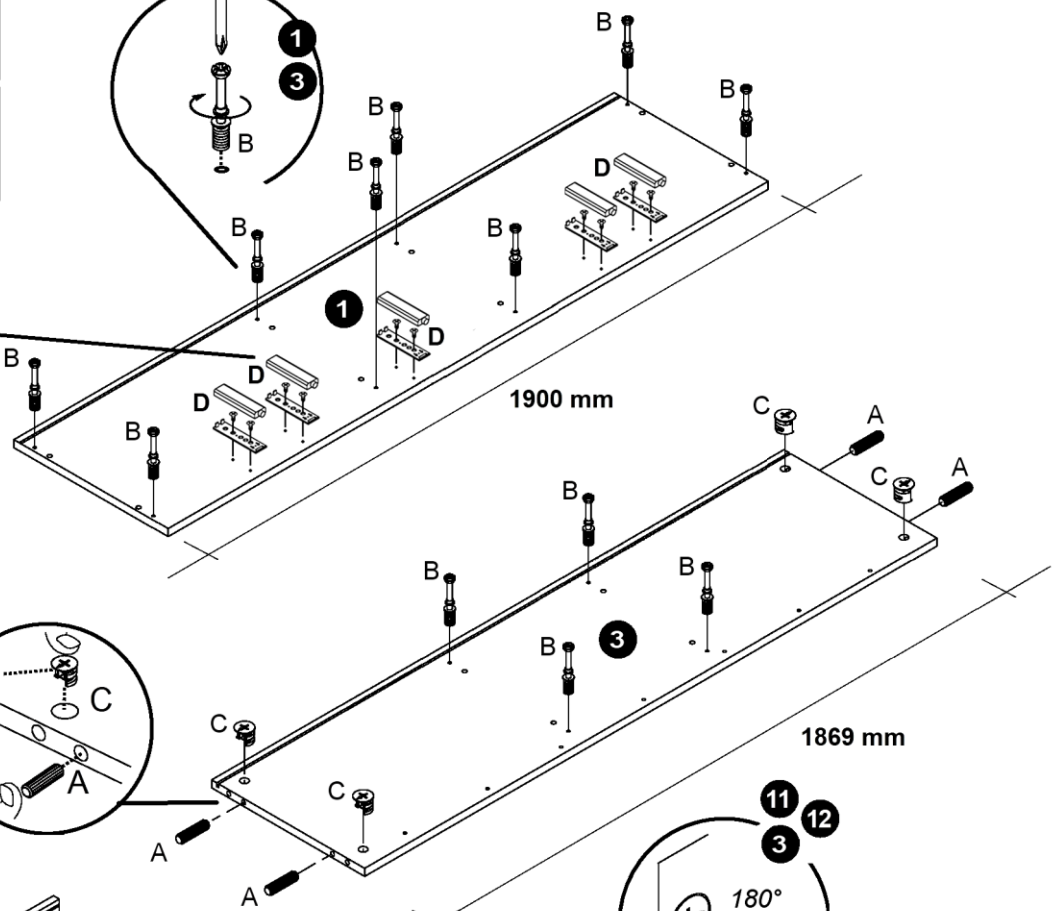
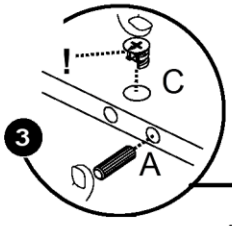
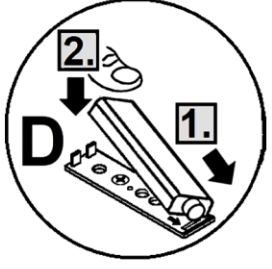
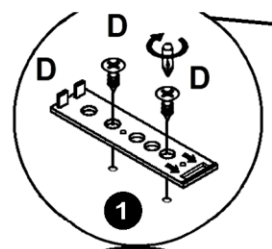
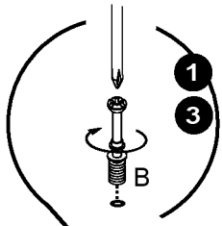

4

- 3,0 x 40
3x **G**

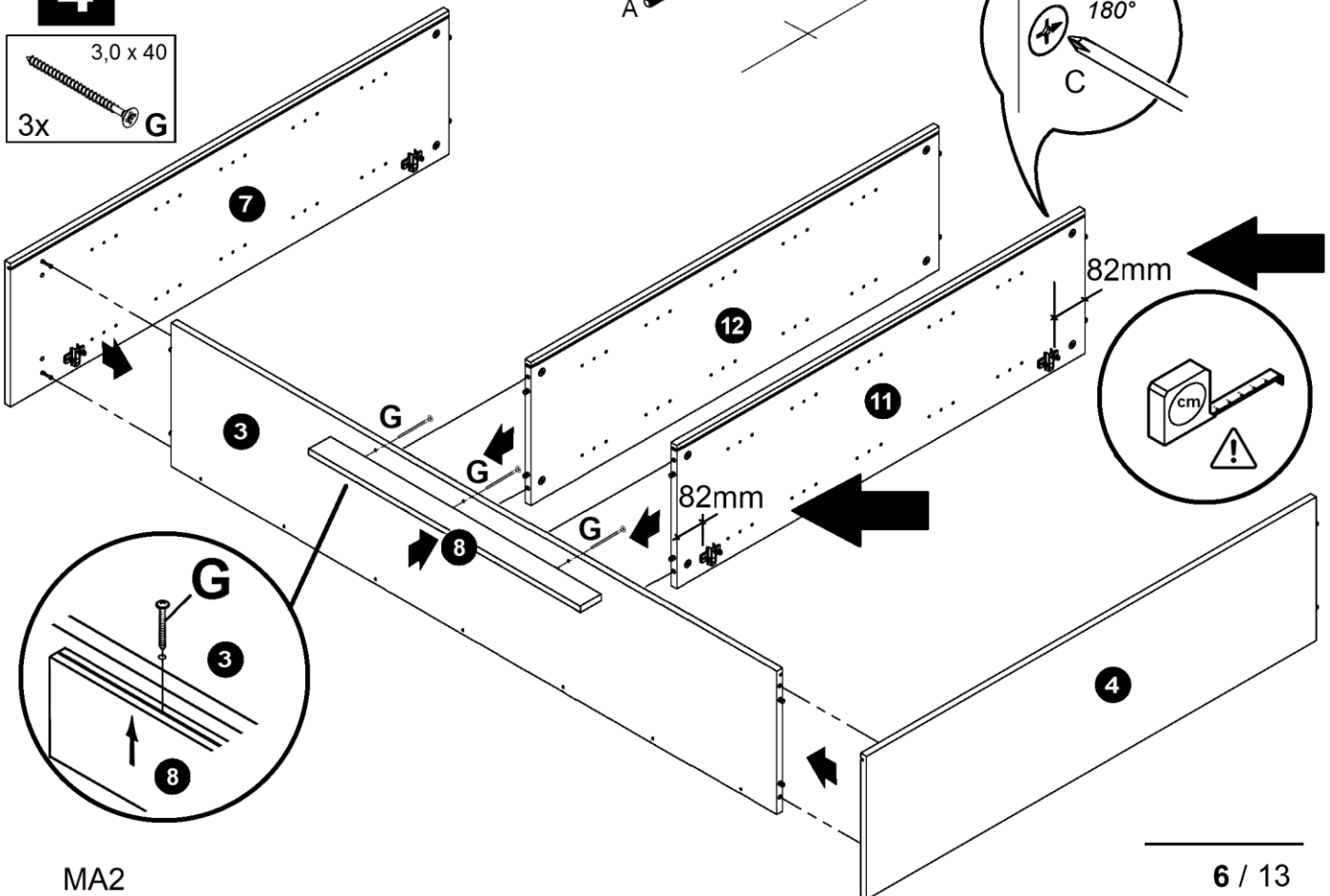

5

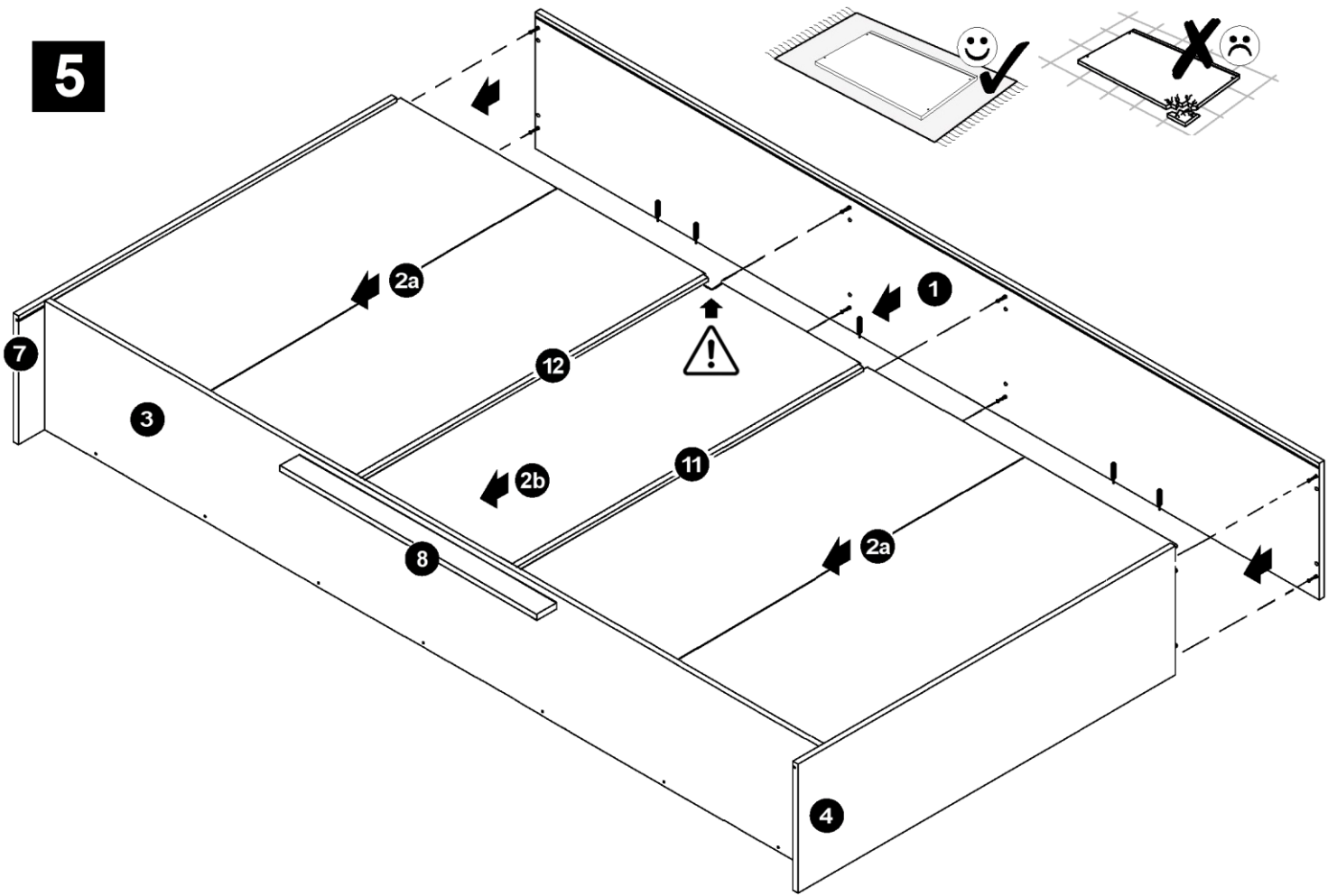

6

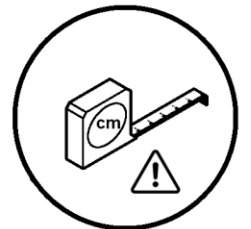
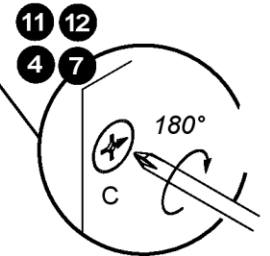
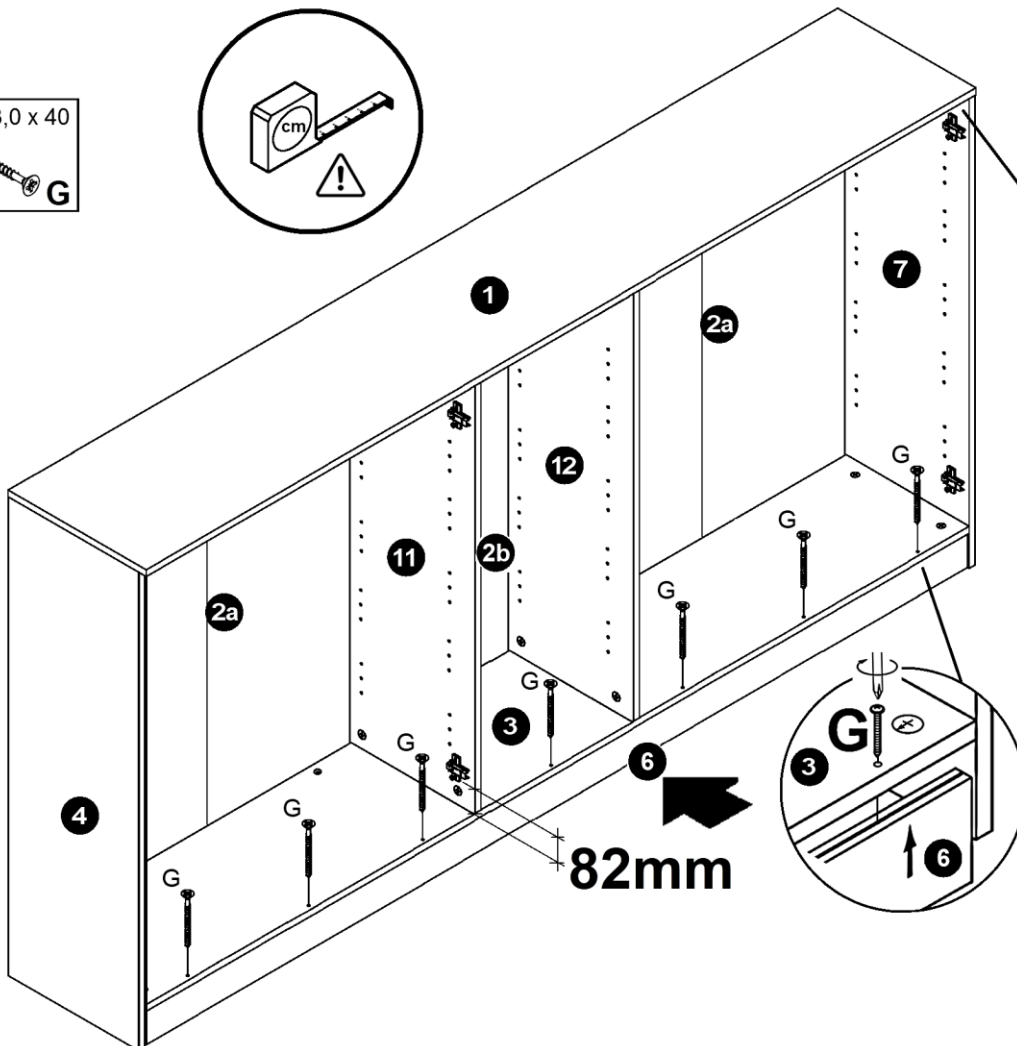
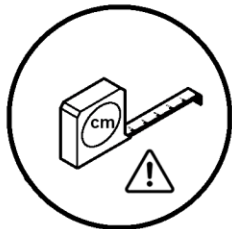
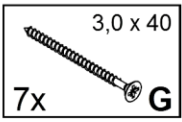

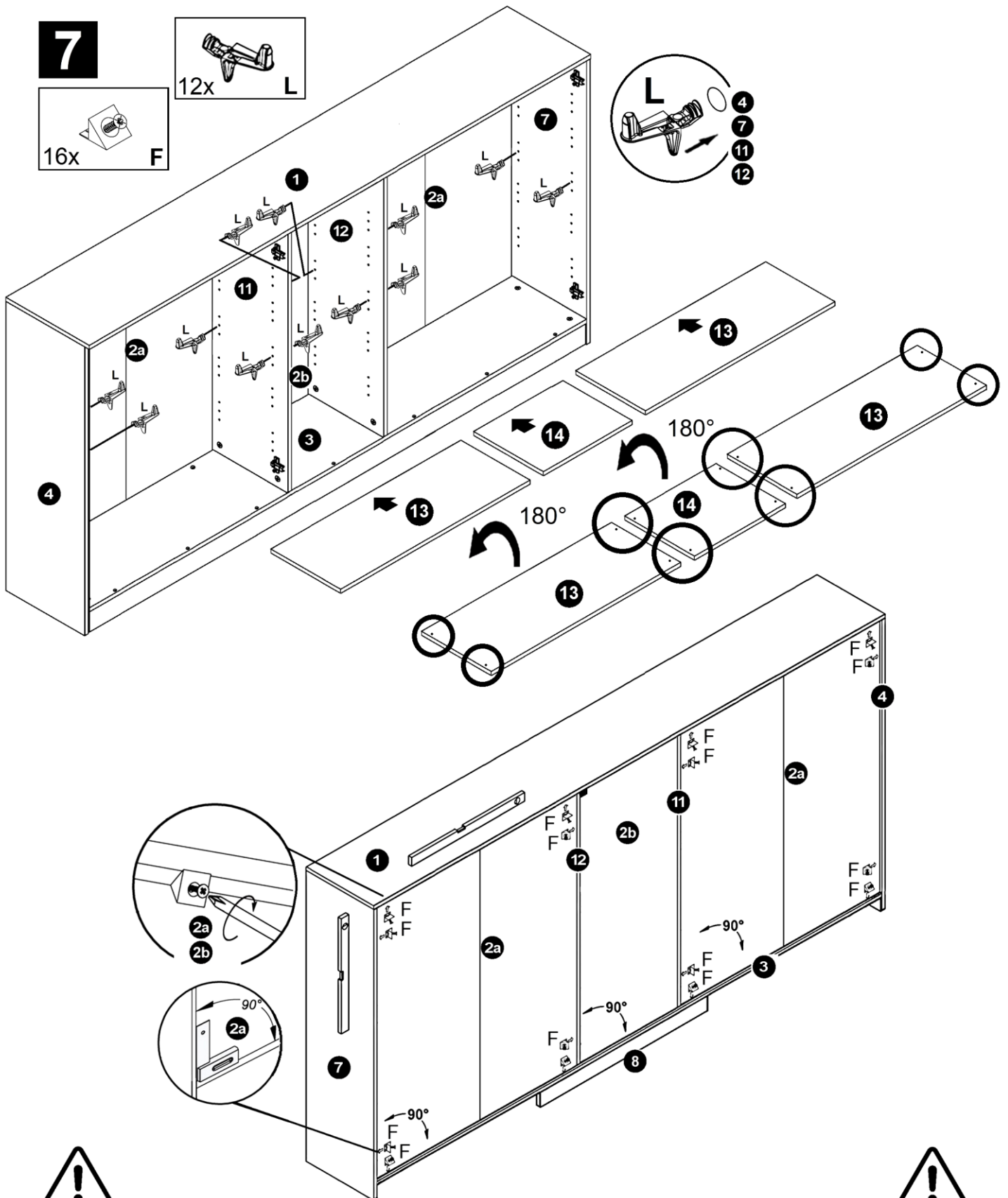

- | | |
|---|---|
| (D) Wichtig! Bitte genau hier anbringen! | (NL) Belangrijk! Voeg hier toe! |
| (GB) Important! Please attach right here! | (PL) Ważne! Dołącz tutaj! |
| (FR) Important! Veuillez joindre ici! | (CZ) Důležité! Připojte se prosím zde! |
| (RU) Важно! Пожалуйста, прикрепите прямо здесь! | (RO) Important! Vă rugăm să atașați chiar aici! |
| (TR) Önemli! Lütfen buraya ekleyin! | (HU) Fontos! Kérjük, csatolja ide! |
| (IT) ! importante Si prega di allegare proprio qui! | (SK) Dôležité! Pripojte, prosím, tu! |

8

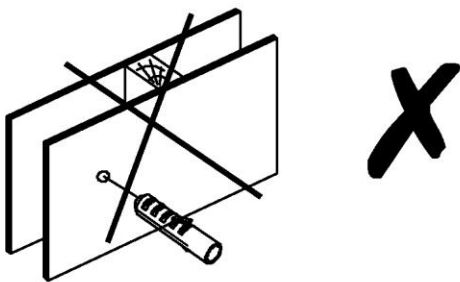
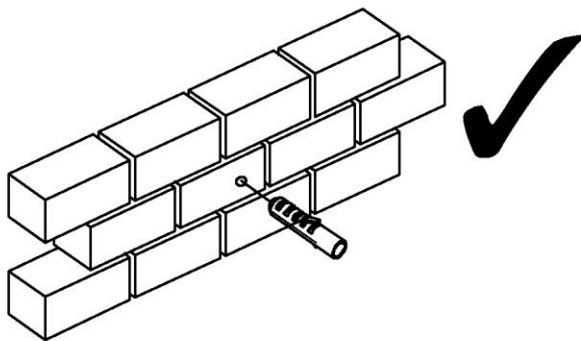
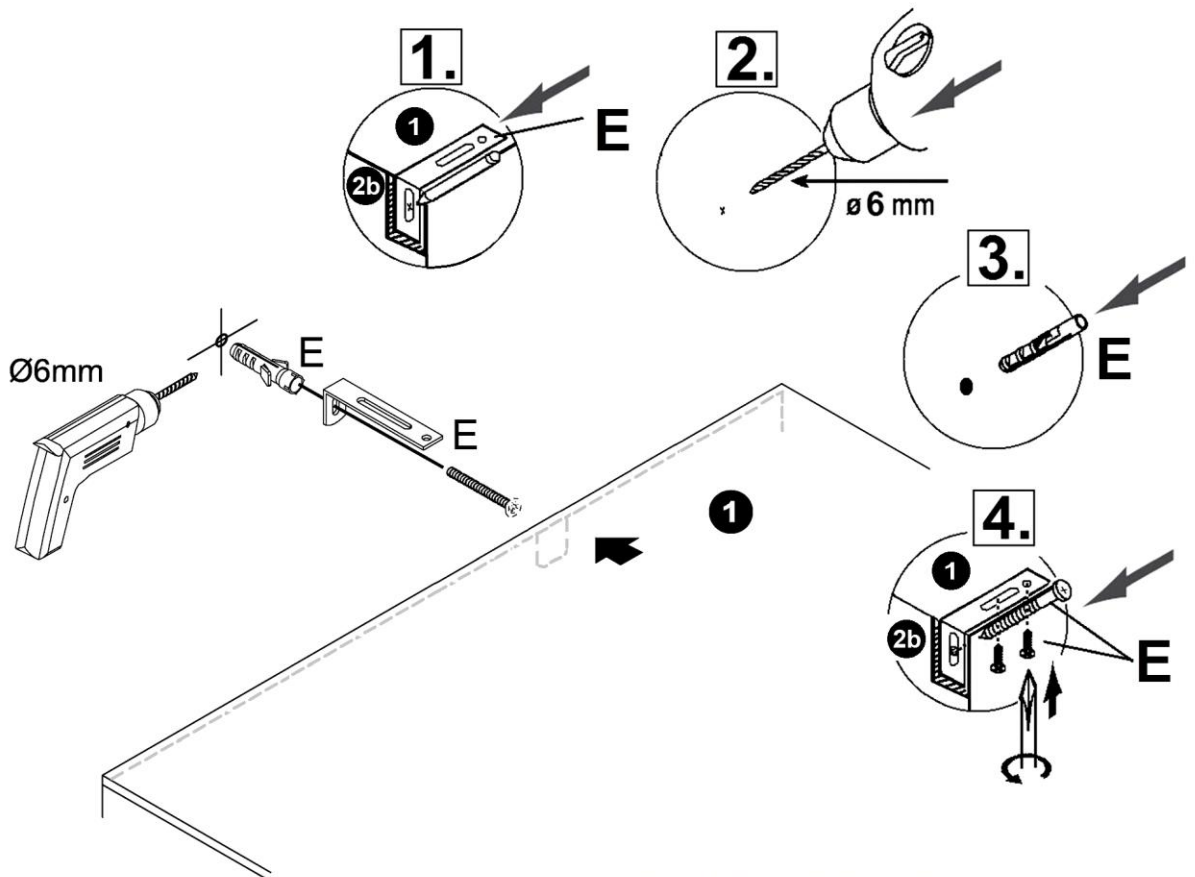
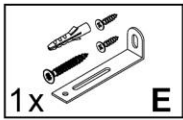

Achtung • Attention • Attenzione Opgelet • Uwaga • Pozor • Figyelem Atenție • Dikkat • Внимание	
(D)	Wandbefestigung dient als Kippschutz – unbedingt anbringen! Bei einigen Wandtypen kann ein Spezialdübel erforderlich sein!
(GB)	The wall fastening serves to prevent tipping – be absolutely sure to mount it! For certain wall types, a special wall plug may be necessary!
(FR)	La fixation murale sert de protection contre le basculement – à installer impérativement ! Pour certains types de murs il faut des chevilles spéciales !
(IT)	Il fissaggio alla parete serve da protezione anti-ribaltamento – attaccarla assolutamente! Per alcune strutture di parete può essere necessario un tassello speciale!
(NL)	Bevestiging aan de muur dient als kantelbescherming – zeker en vast bevestigen! Bij enkele muurtypes is een speciale plug misschien vereist!
(PL)	Mocowanie do ściany jest jednocześnie zabezpieczeniem przed przewróceniem – koniecznie zamontować! Do niektórych rodzajów ścian konieczne zastosować specjalne kołki mocujące.
(CZ)	Montáž na stěnu slouží jako ochrana proti převrnutí – bezpodmínečně umístěte! U některých typů stěn může být zapotřebí speciální hmoždinka!
(SK)	Upevnenie na stenu slúži ako ochrana proti prevráteniu – bezpodmienečne použite! Pre niektoré druhy stien môže byť potrebná špeciálna hmoždinka!
(HU)	A terméket a falhoz kel rögzíténi, különben az felbörulhat! Egyes faltípusoknál speciális tiplit kell használni!
(RO)	Sistemul de fixare la perete servește ca protecție la răsturnare – de montat obligatoriu! Pentru unele tipuri de pereți este posibil să fie necesar un diblu special!
(TR)	Duvardaki sabitleme, devrilmeye karşı bir emniyet tedbiridir ve mutlaka monte edilmelidir! Bazı duvar tiplerinde bunun için özel bir dübel gerekli olabilir!
(RU)	Обязательно установите крепление на стене во избежание опрокидывания! Для некоторых типов стен может потребоваться специальный дюбель!

9

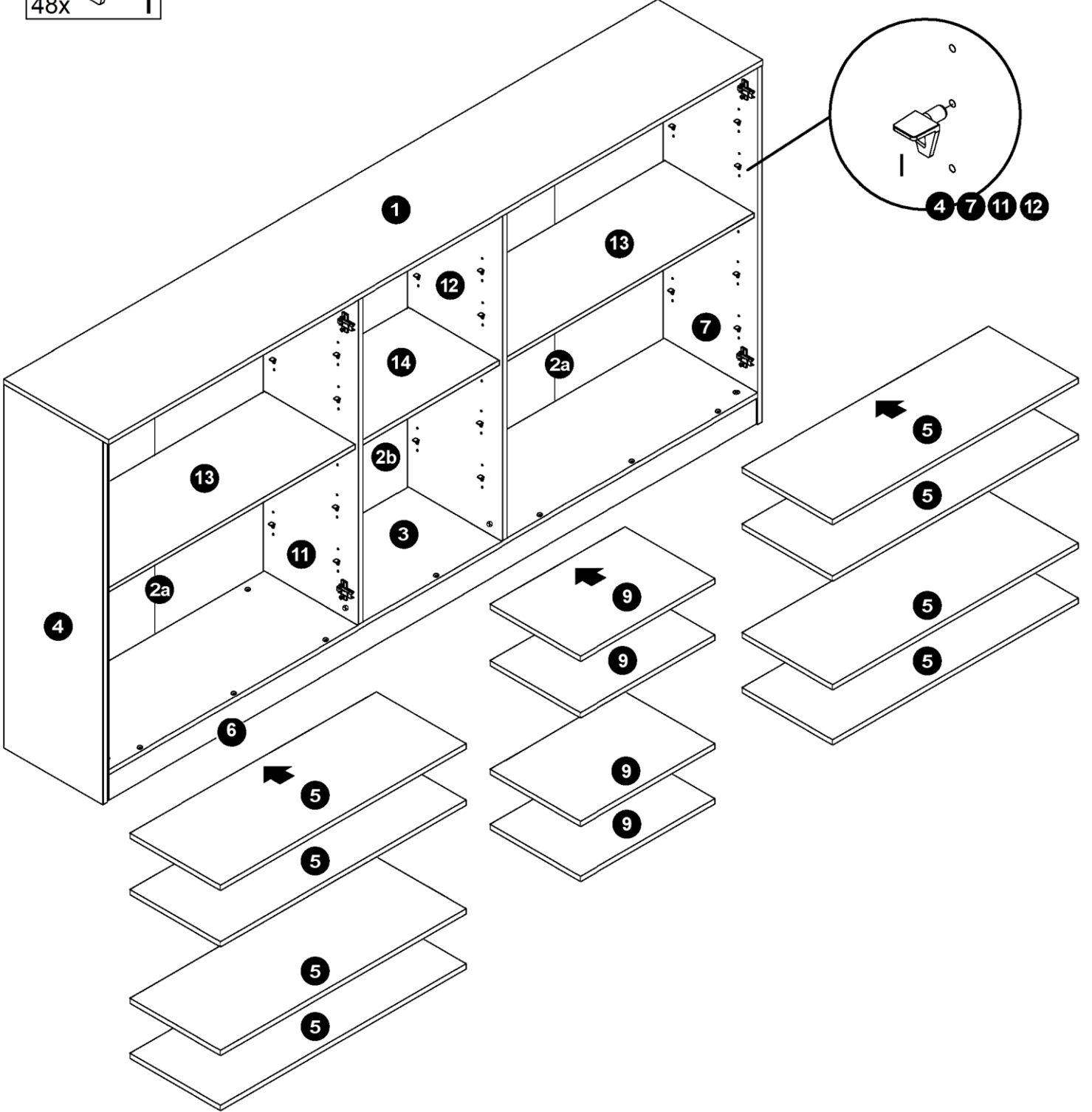
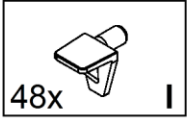

10

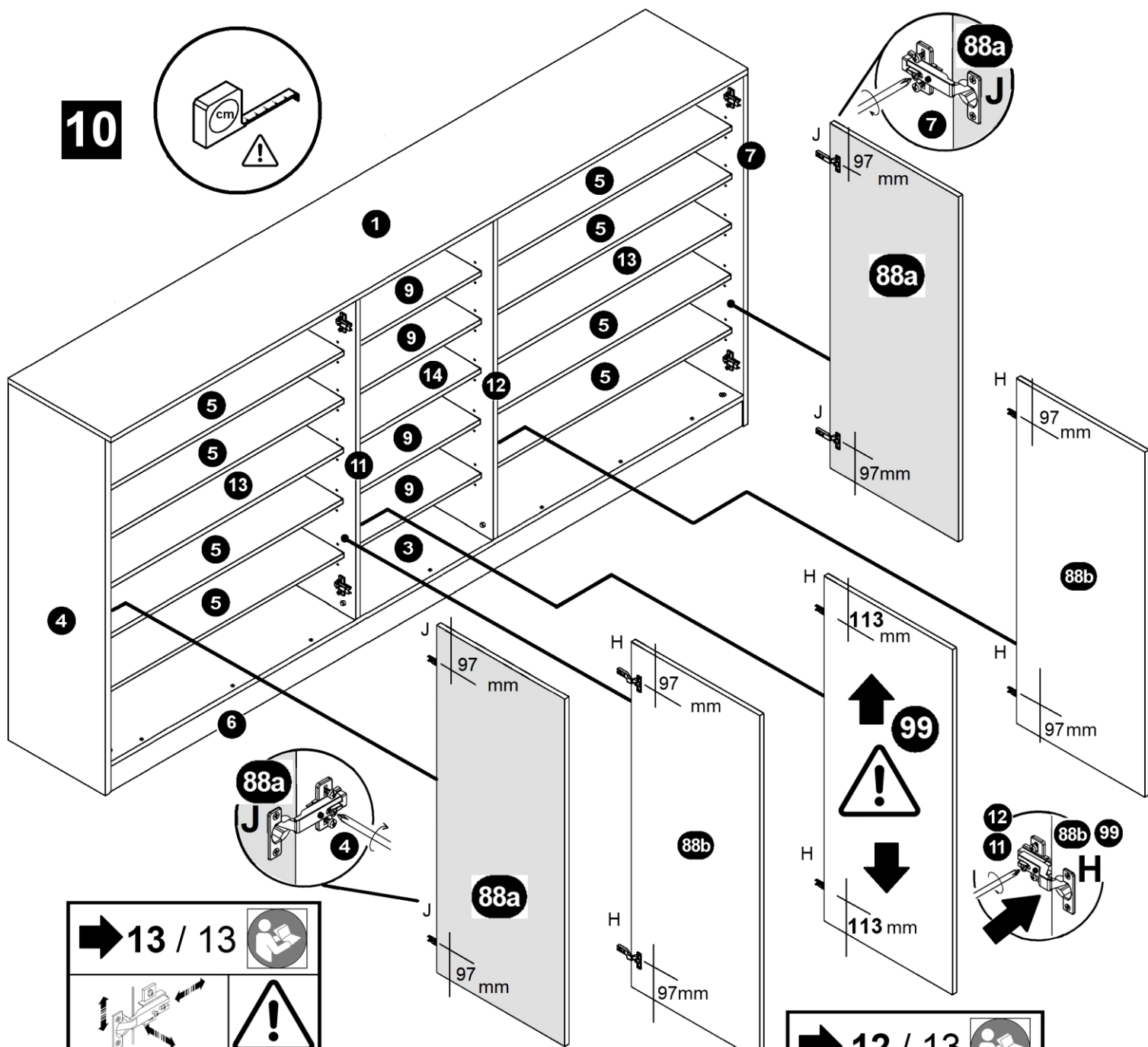
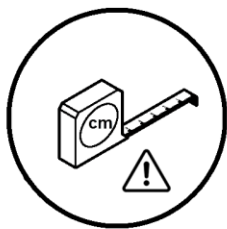

➔ 13 / 13

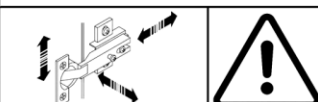



- (D) Türen einstellen (Scharniere justieren)
- (GB) Adjusting the doors (adjusting the hinges)
- (FR) Régler les portes (ajuster les charnières)
- (IT) Sistemare le porte (regolare le cerniere)
- (NL) Deuren instellen (scharnieren afstellen)
- (PL) Nastawić drzwi (wyregulować zawiasy)
- (CZ) Vyrovnajte dvířka (seřid'te závěsy)
- (RO) Nastavenie dveri (nastavenie závesov)
- (HU) Állítsa be az ajtókat (állítsa be a zsanérokat)
- (SK) Reglare uši (ajustare balamale)
- (TR) Kapıların ayarlanması (mentşelerin seviye ayarı)
- (RU) Регулировка дверей (регулировка шарнира)

➔ 12 / 13

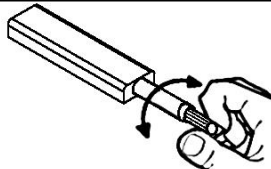

- (D) Push-To-Open einstellen
- (GB) Adjusting the Push-To-Open
- (FR) Régler les Push-To-Open
- (IT) Sistemare Push-To-Open
- (NL) Push-To-Open instellen
- (PL) Nastawić Push-To-Open
- (CZ) Vyrovnajte Push-To-Open
- (RO) Nastavenie Push-To-Open
- (HU) Állítsa be az Push-To-Open
- (SK) Reglare Push-To-Open
- (TR) Push-To-Open ayarlanması
- (RU) Регулировка Push-To-Open

		
<p>(D) Push-To-Open einstellen</p>	<p>(CZ) Vyrovnajte Push-To-Open</p>	
<p>(GB) Adjusting the Push-To-Open</p>	<p>(RO) Nastavenie Push-To-Open</p>	
<p>(FR) Régler les Push-To-Open</p>	<p>(HU) Állítsa be az Push-To-Open</p>	
<p>(IT) Sistemare Push-To-Open</p>	<p>(SK) Reglare Push-To-Open</p>	
<p>(NL) Push-To-Open instellen</p>	<p>(TR) Push-To-Open ayarlanması</p>	
<p>(PL) Nastawić Push-To-Open</p>	<p>(RU) Регулировка Push-To-Open</p>	

1.

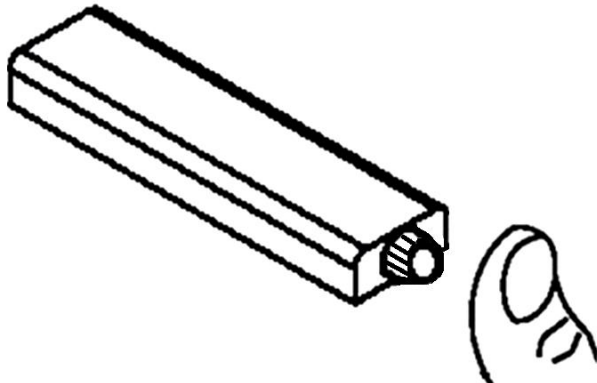

2.

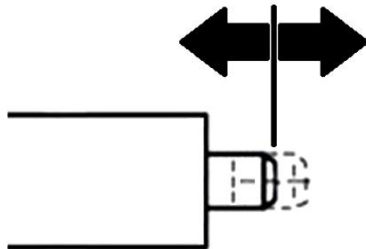
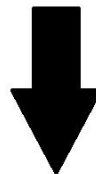
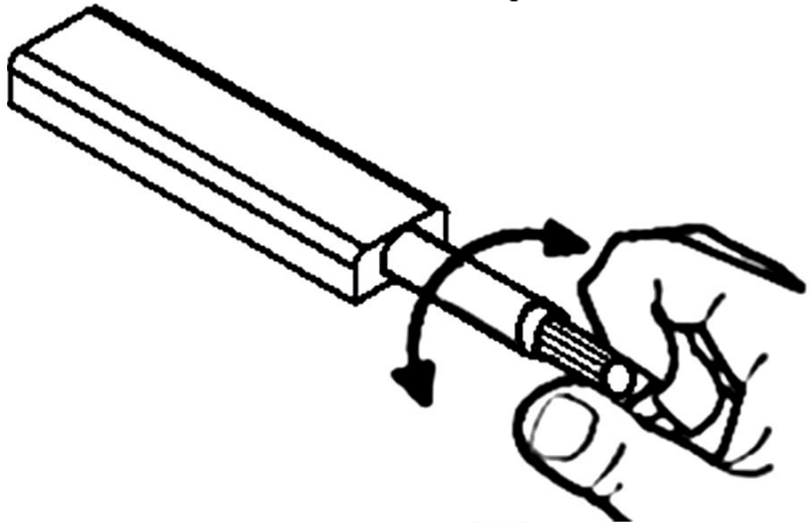

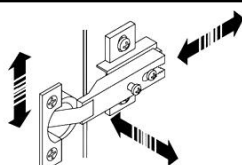

(D) Türen einstellen
(Scharniere justieren)

(GB) Adjusting the doors
(adjusting the hinges)

(FR) Régler les portes
(ajuster les charnières)

(IT) Sistemare le porte
(regolare le cerniere)

(NL) Deuren instellen
(scharnieren afstellen)

(PL) Nastawić drzwi
(wyregulować zawiasy)

(CZ) Vyrovnajte dvířka
(seřid'ťe závěsy)

(RO) Nastavenie dverí
(nastavenie závesov)

(HU) Állítsa be az ajtókat
(állítsa be a zsanérokát)

(SK) Reglare uši
(ajustare balamale)

(TR) Kapıların ayarlanması
(mentşelerin seviye ayarı)

(RU) Регулировка дверей
(регулировка шарнира)

