

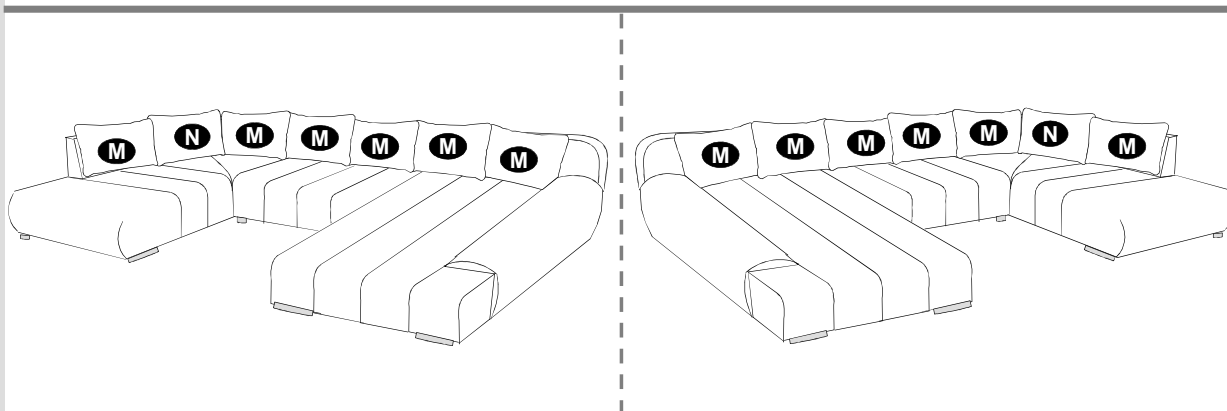

»Bono«

- | | | | |
|-----------|------------------------------------|-----------|--------------------------------|
| D | Montageanleitung | GB | Assembly instructions |
| NL | Handleiding voor de montage | PL | Instrukcja montażu |
| TR | Montaj talimat | RU | Инструкция по монтажу |
| RO | Instrucțiuni de instalare | IT | Istruzioni di montaggio |
| FR | Notice de montage | SK | Montážny návod |
| CZ | Montážní návod | HU | Szerelési útmutató |



1

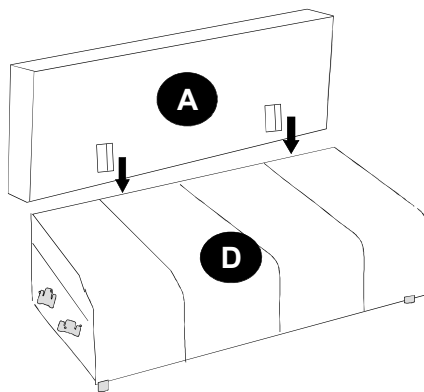

2

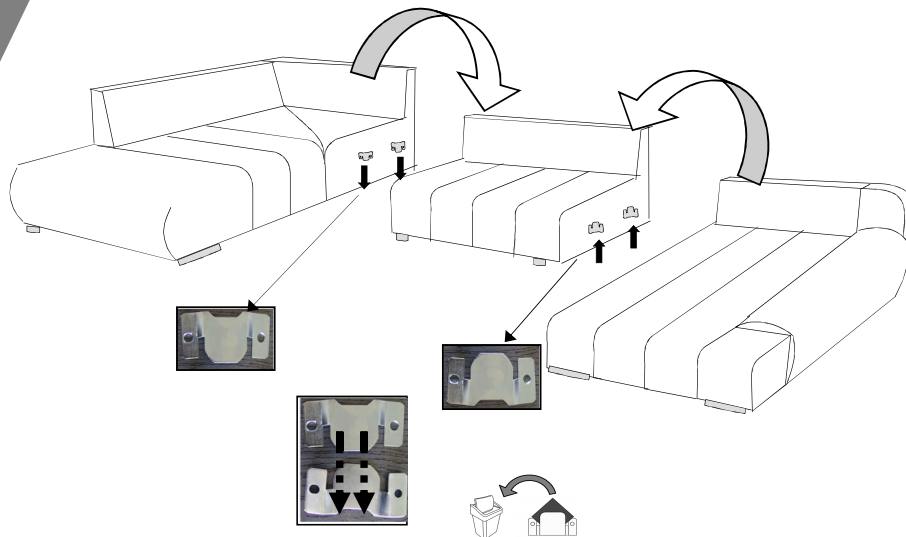

Service · Dienstverlening · Serwis · Servis · Сервисная служба · Serviciu · Servizio
 · Služby · Szolgáltatás

Name · Naam · Nazwa · Isim · Название · Nume · Nome · Názov

Názov · Název · Neve

BONO

Nr. · No · Номер · Nu · Nombre · Číslo · Száma

Typ · Type · Tip · Тип · Típo · Típus

xyz

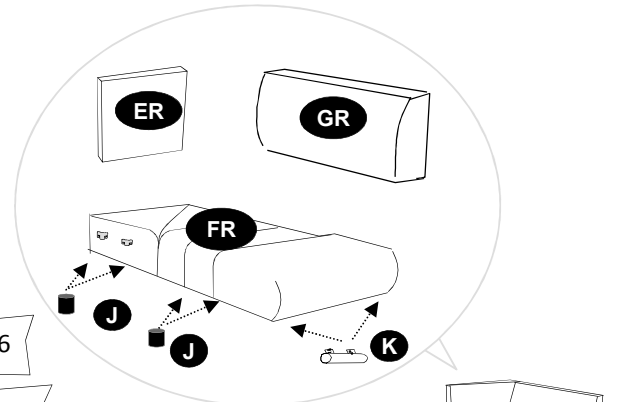
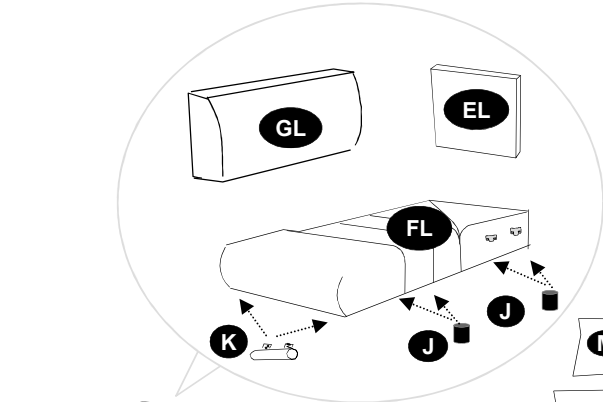
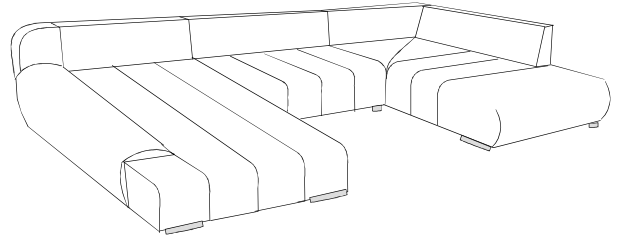
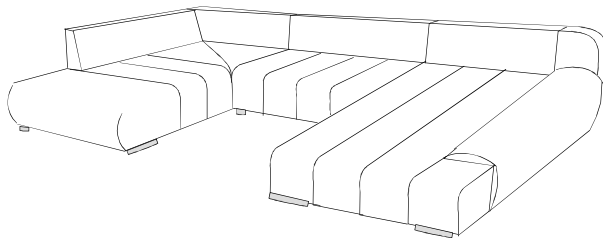
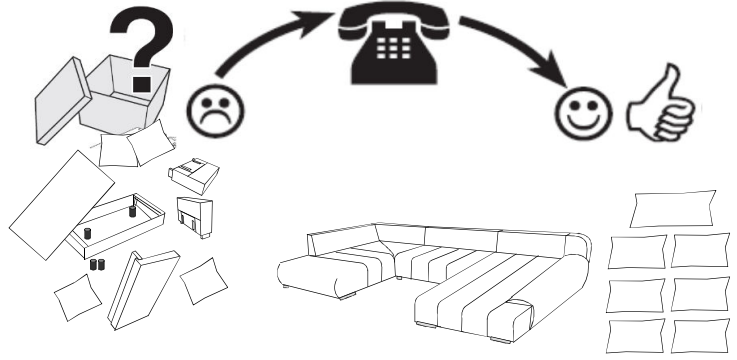

M x6
 N x1

