

D Aufbauanleitung

NL Handleiding voor de Montage

PL Instrukcja montażu

SK Montážny návod

RO Instrucțiuni de asamblare

GB Assembly Instruction

TR Montaj Talimatları

CZ Shromazďování instrukce

I Istruzioni per il montaggio

F Instructions de montage

RU Инструкция по монтажу

H Gennyesevés utasítások

Boxspringbett Madrid Variante mit Topper

Polsterbett-Gestoffteerde bed-Tapicerowane łóżko-Tapizata pat-Upholstered bed-Мягкая кровать-ятак капитоне-Letto imbottito-Lit rembourré
Čakuné postele čalounené postele kárpitovaný ágy

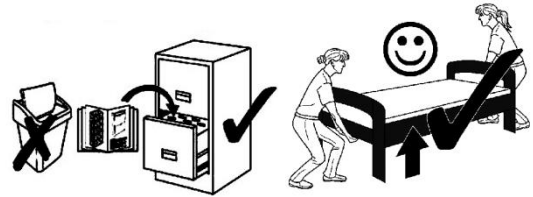
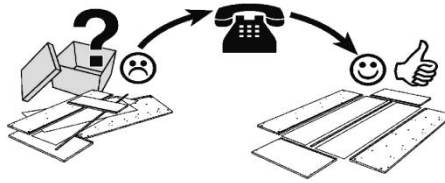

90cm, 100cm, 120cm

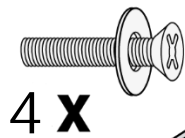

4 X

1 X

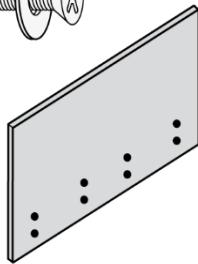

1 X

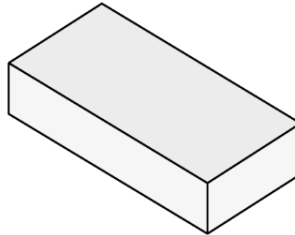

4 X



1 X

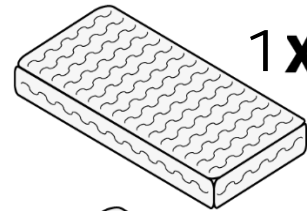

1 X

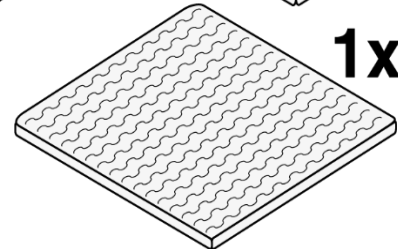

Schrauben in der Kopfteilverpackung enthalten

140 cm

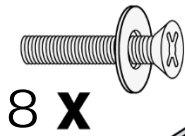

8 X

1 X

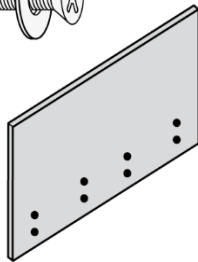

2 X

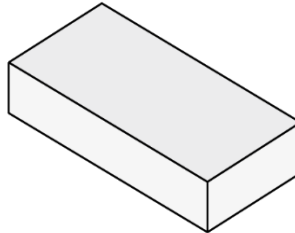

8 X



1 X

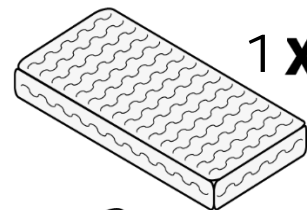

1 X

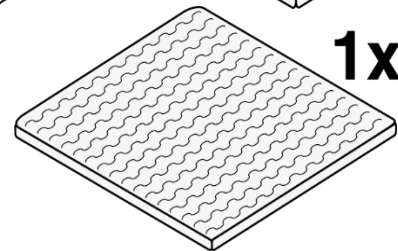

Schrauben in der Kopfteilverpackung enthalten

160cm, 180cm, 200cm

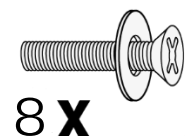

8 X

1 X

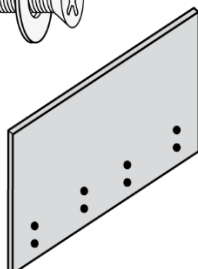

2 X

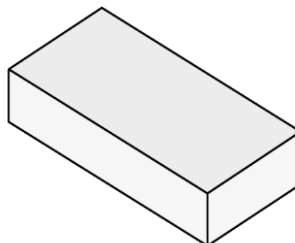

8 X



2 X

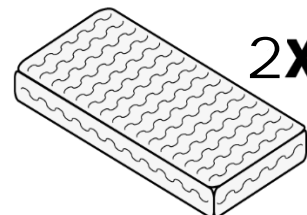

1 X

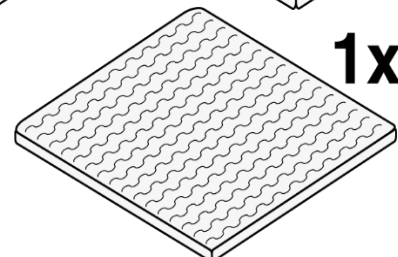

Schrauben in der Kopfteilverpackung enthalten

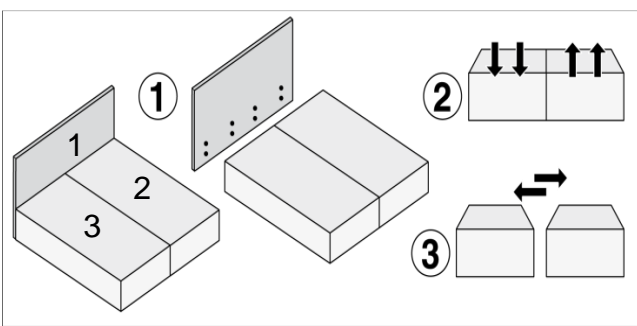
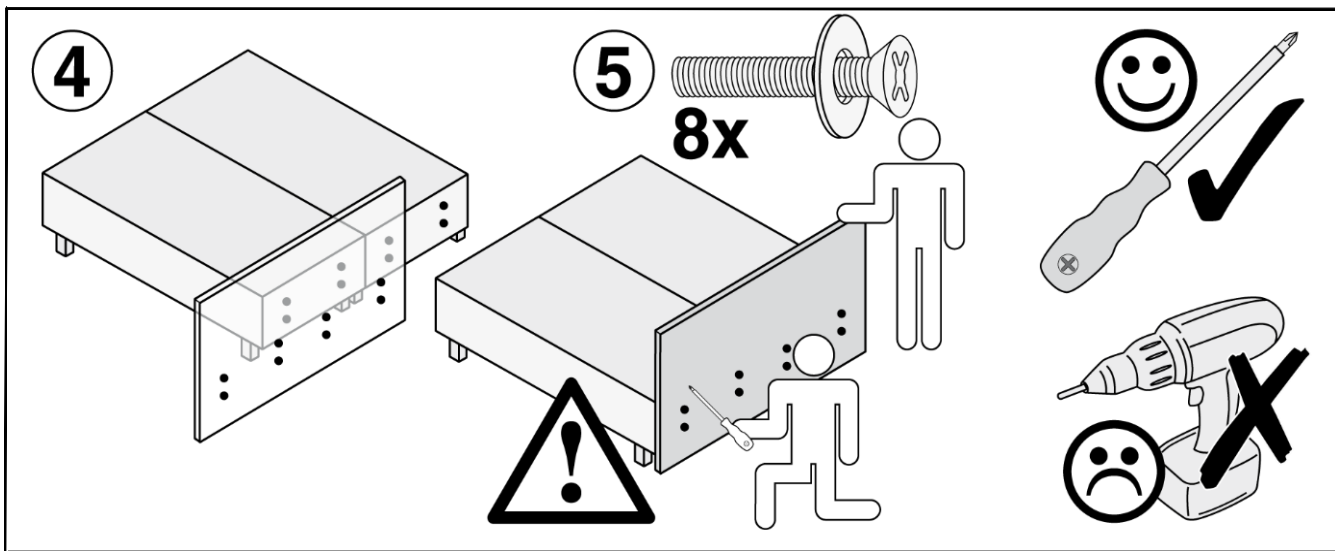
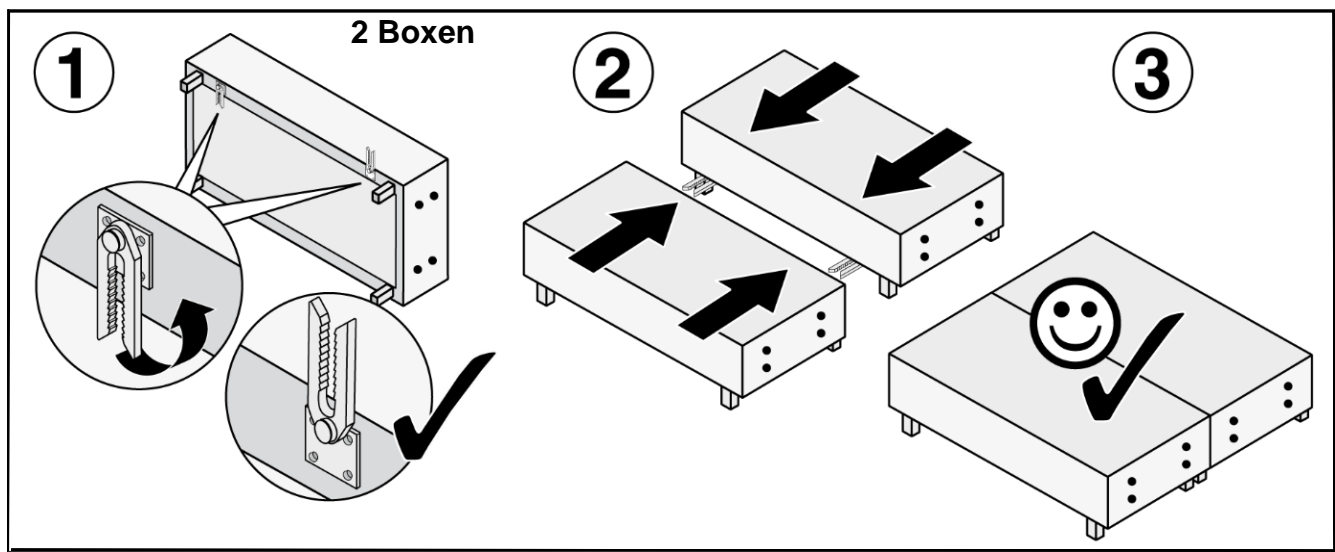
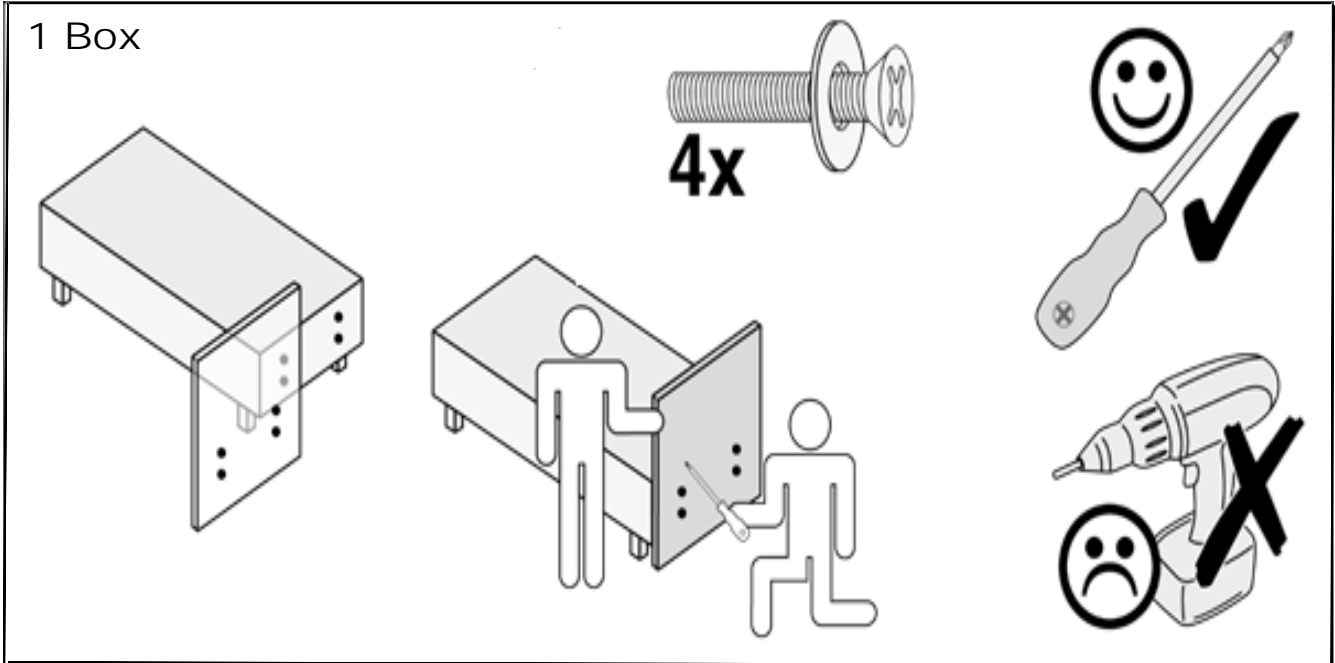

WESTFALIA
Polsterbetten

Made in Germany

Elastoflex GmbH
Löhner Straße 123
32584 Löhne
info@elastoflex-betten.de