

FLORENZ 23M

OPTION L

OPTION R

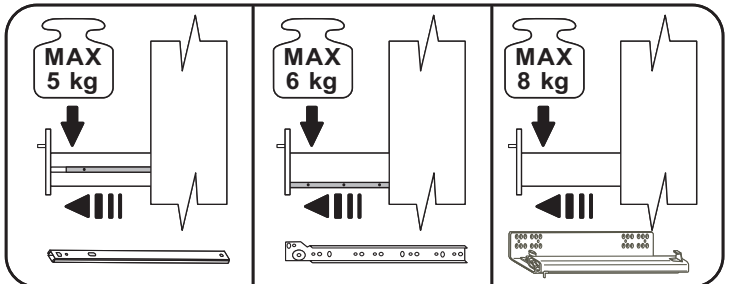
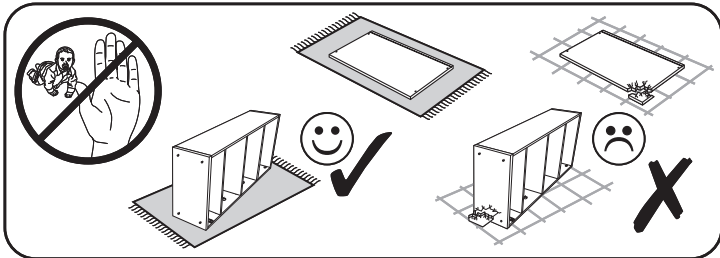
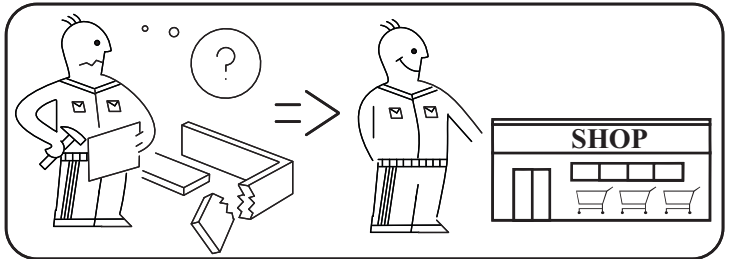
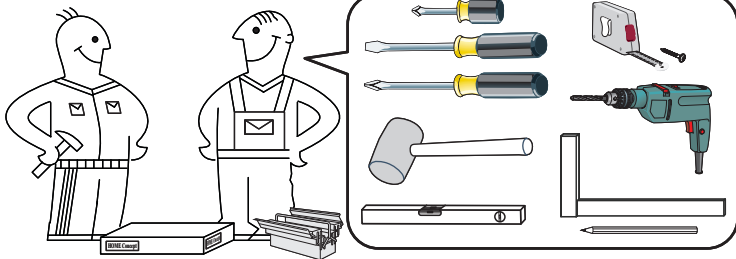
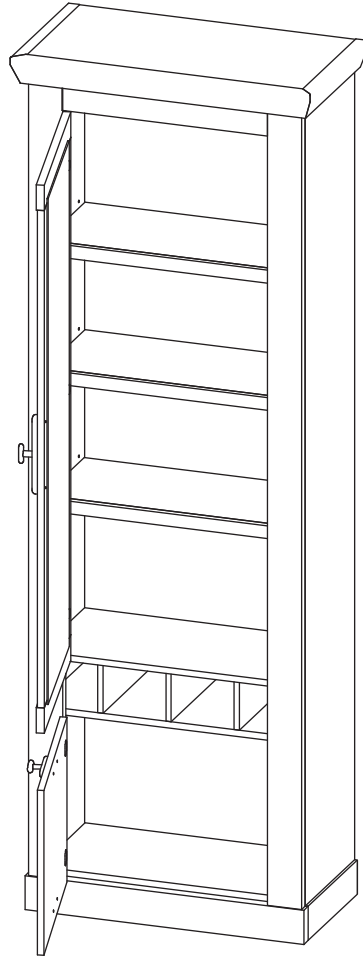
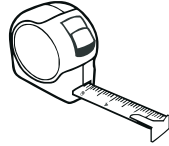
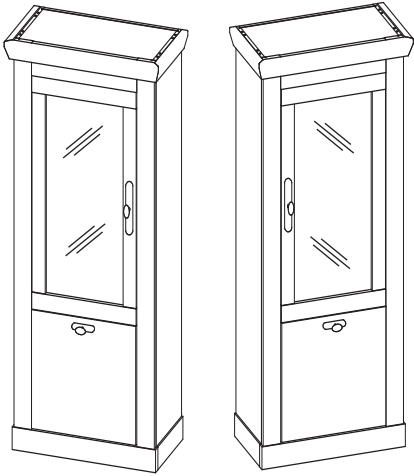

FLORENZ 23M

max. MHC15



5kg MHC12

max.



15kg MHC3

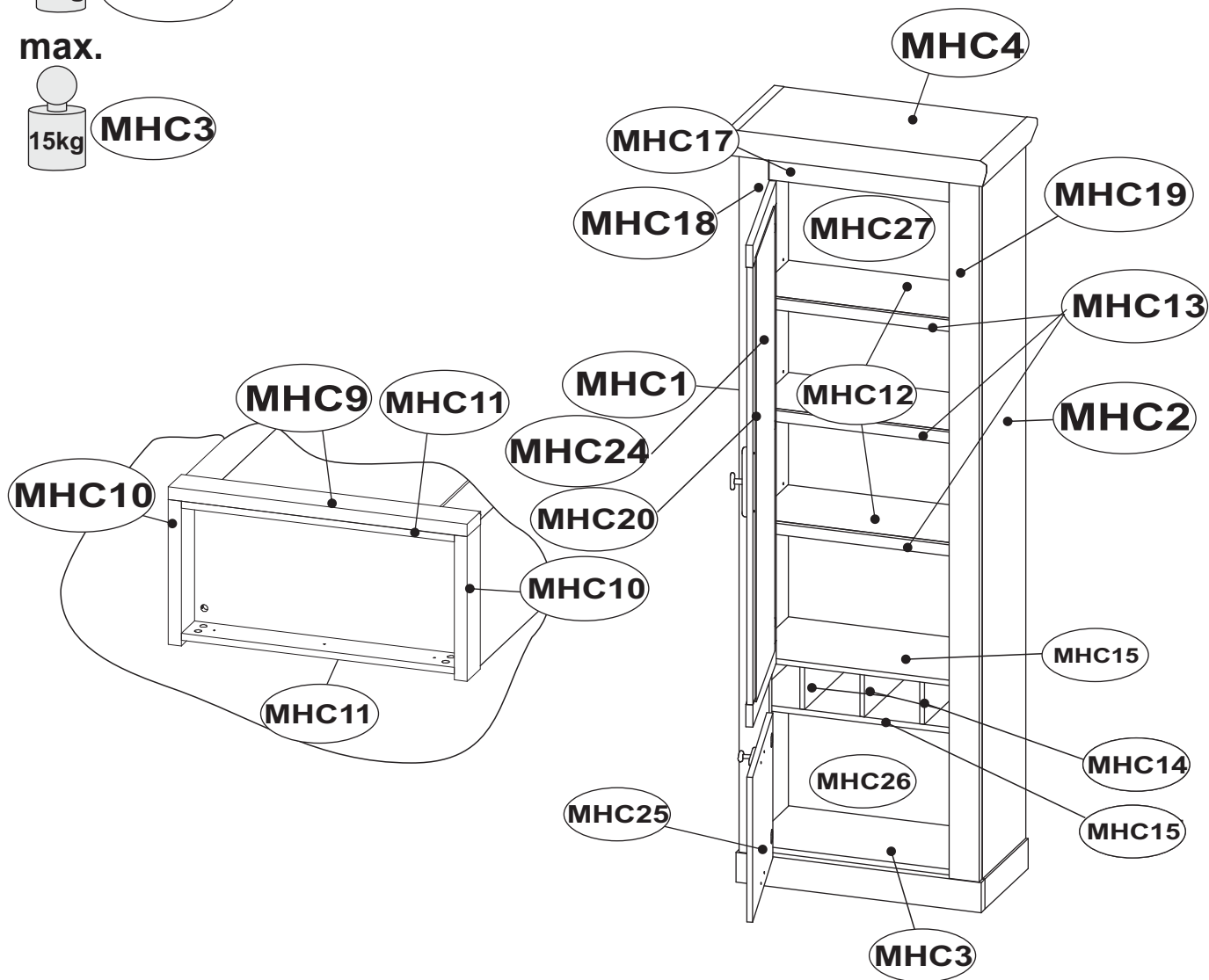

MHC1	1911	320	15	2/2
MHC2	1911	320	15	2/2
MHC3	611	299	15	1/2
MHC4	699	370,5	65	1/2
MHC9	655	80	28	1/2
MHC10	317	80	28	1/2
MHC11	598	80	15	1/2
MHC12	610	267	15	1/2
MHC13	608	30	16	1/2
MHC14	112	298	15	1/2
MHC15	611	299	15	1/2

MHC17	483	120	18	2/2
MHC18	1911	80	22	2/2
MHC19	1911	80	22	2/2
MHC20	1279	477	18	2/2
MHC24	1189	386	4	2/2
MHC25	388	477	15	2/2
MHC26	385	623	3	2/2
MHC27	1531	623	3	2/2

FLORENZ 23M

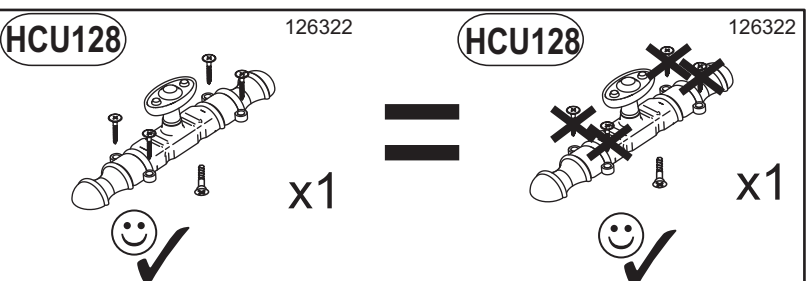
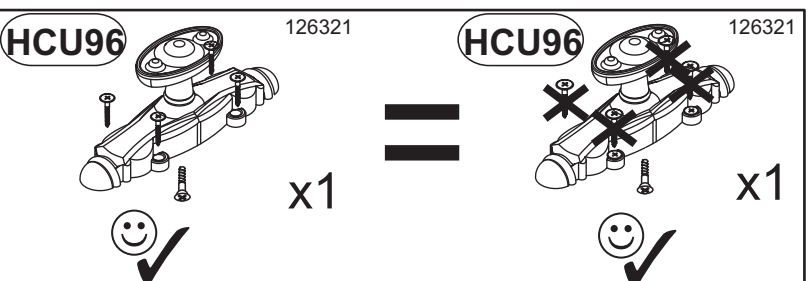
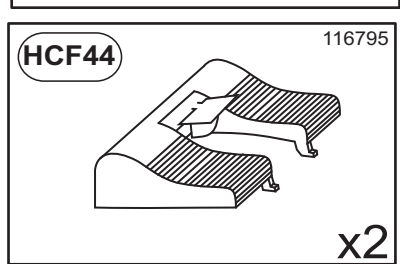
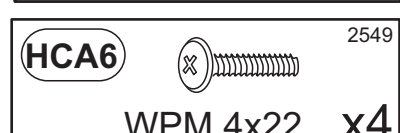
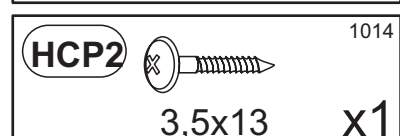
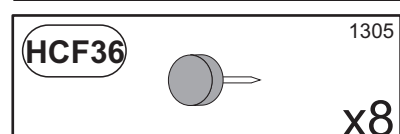
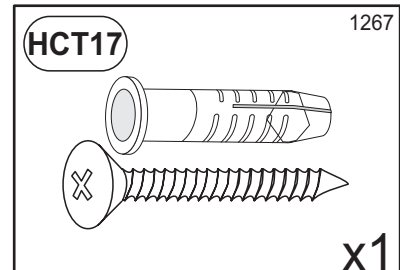
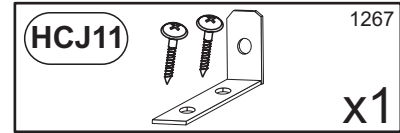
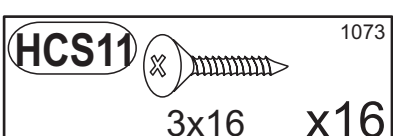
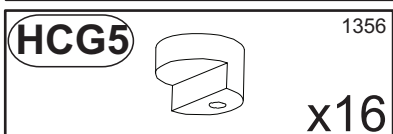
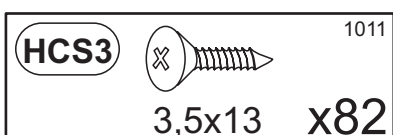
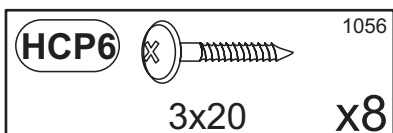
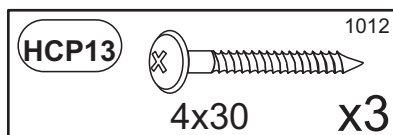
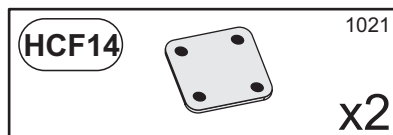
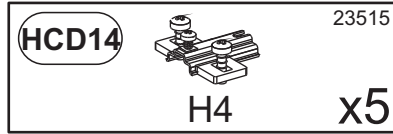
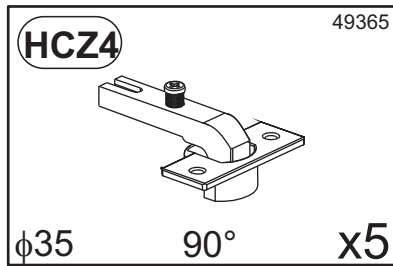
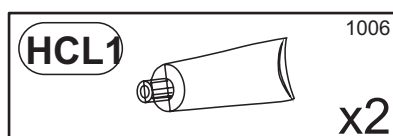
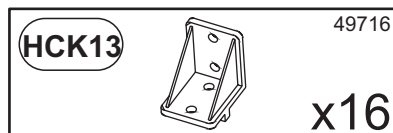
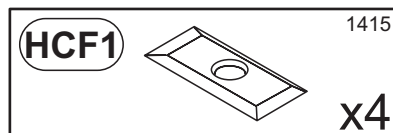
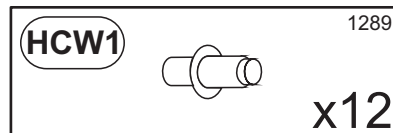
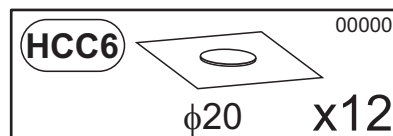
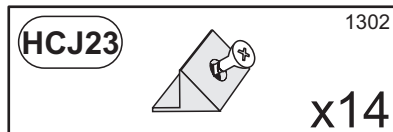
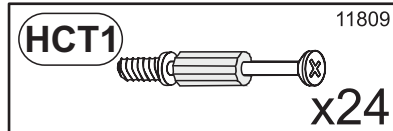
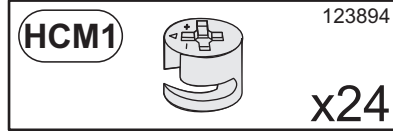
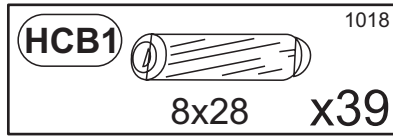

1

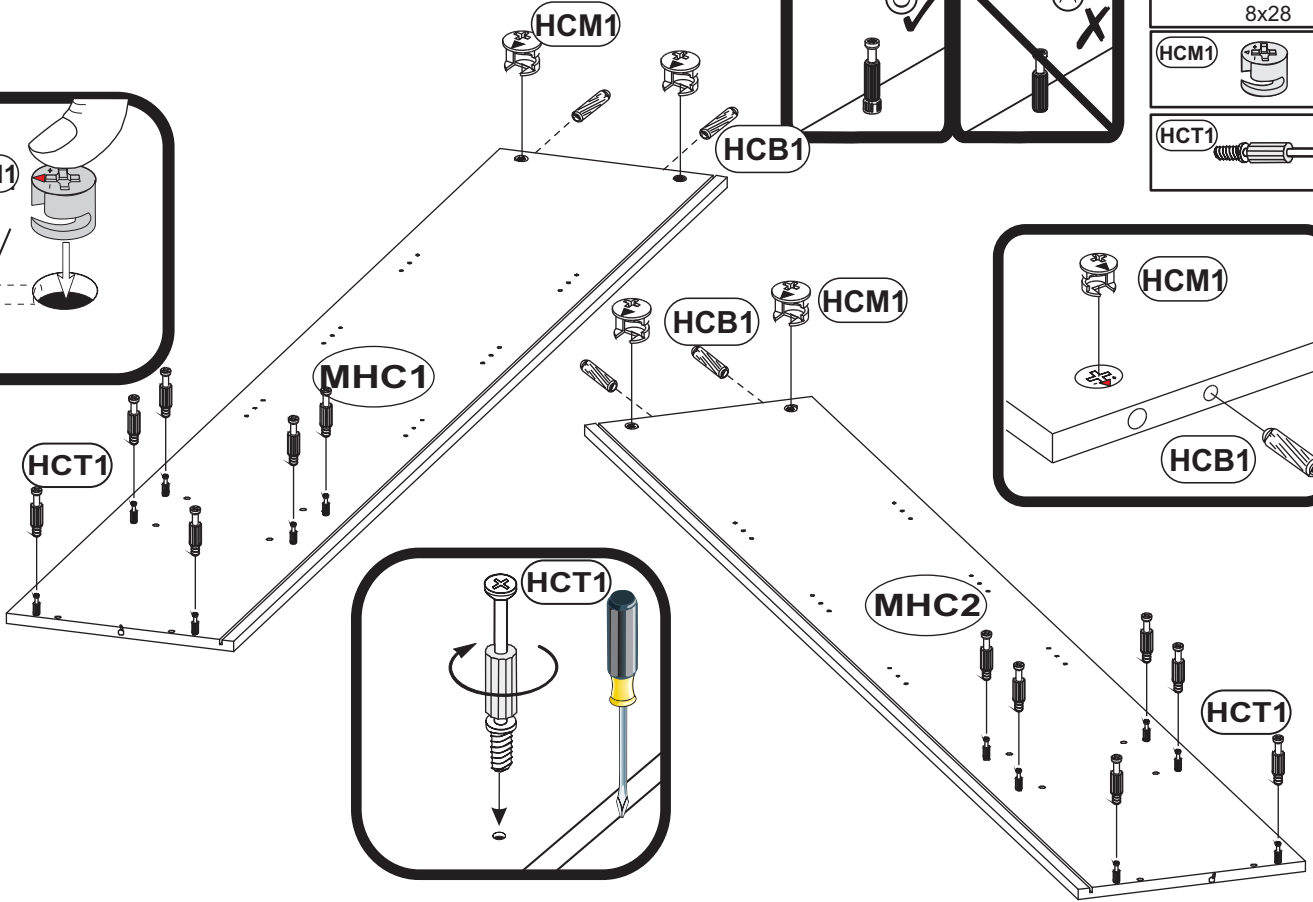
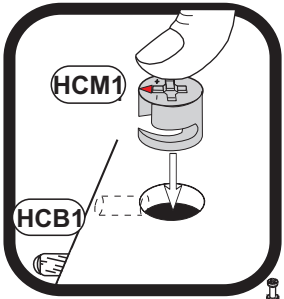

HCB1		1018
	8x28	x4
HCM1		123894
		x4
HCT1		11809
		x12

2

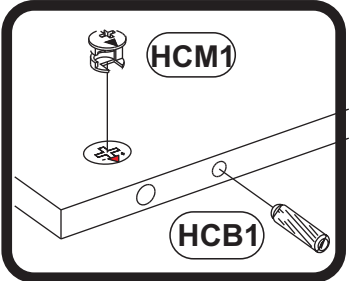
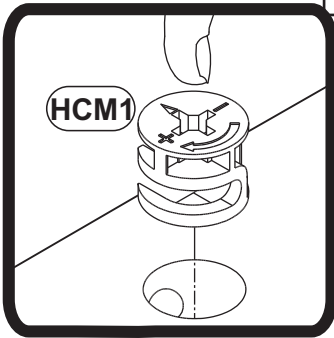
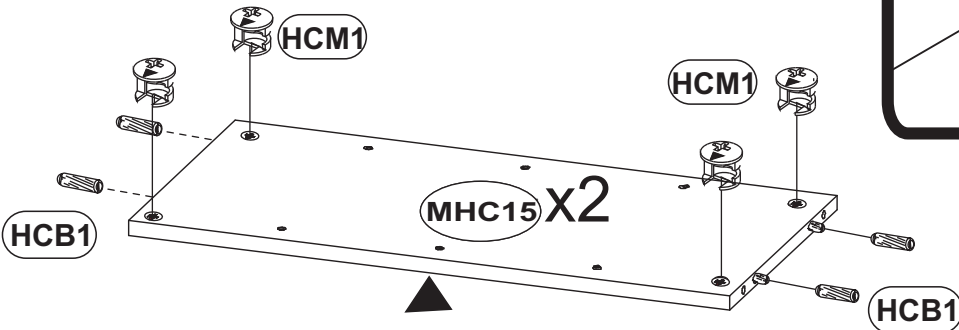

HCM1		123894
		x8
HCB1		1018
	8x28	x8

3

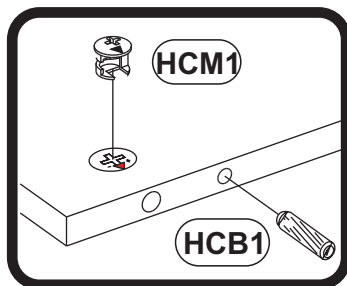
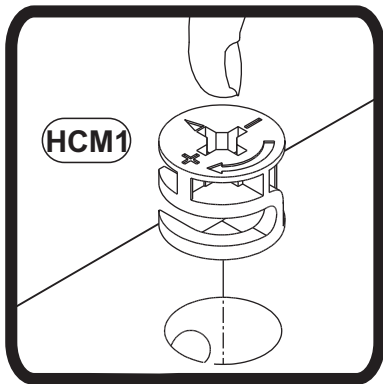

HCS3 1011
3,5x13 x4

HCM1 1336
x4

HCB1 1018
8x28 x16

HCF14 1021
x2

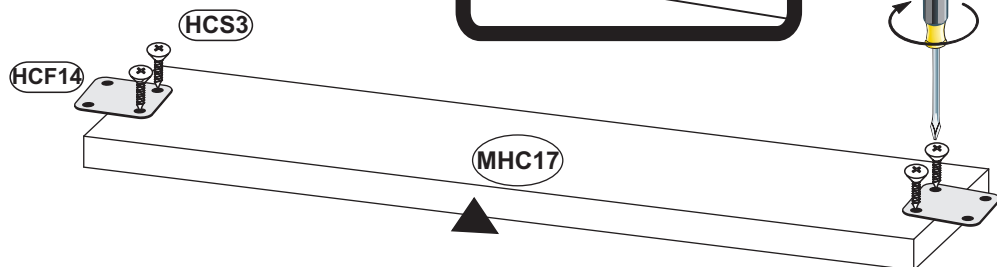
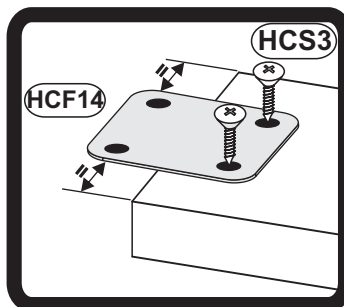
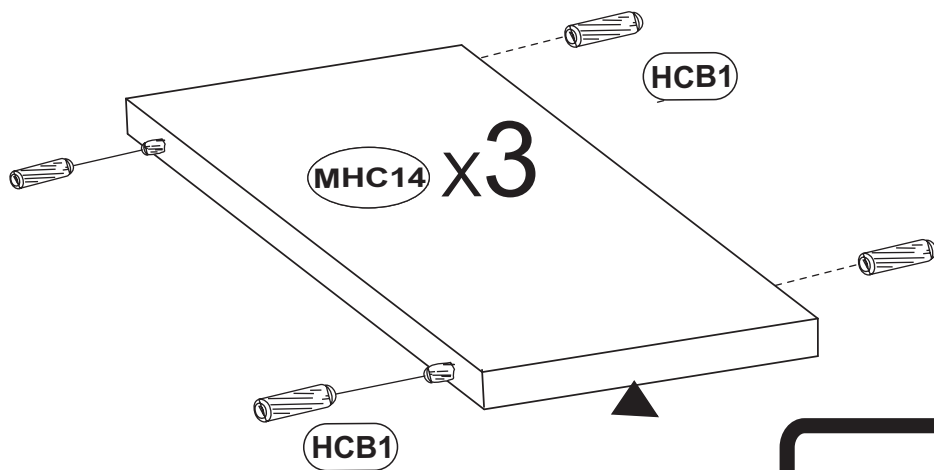
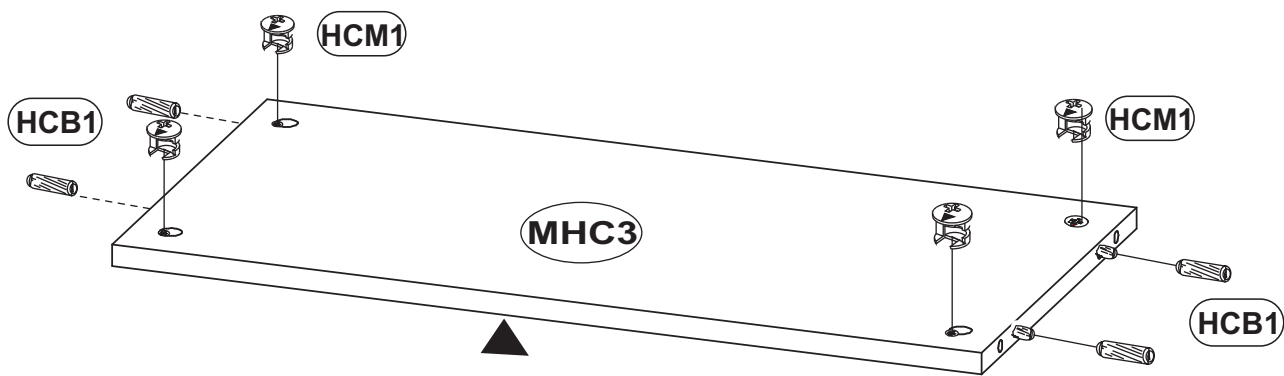

4

OPTION L

OPTION L

HCK13		49716	x12
HCD14		23515	x5
HCS3		1011	3,5x13 x24

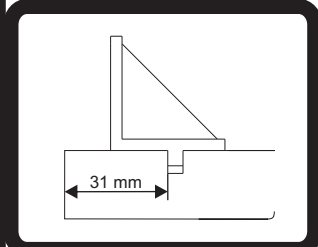
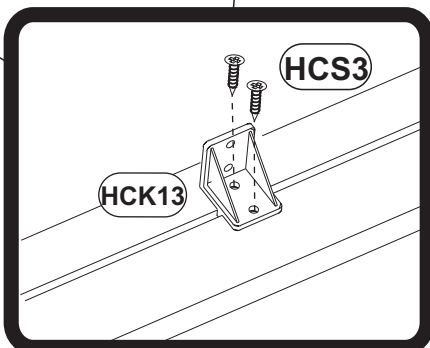
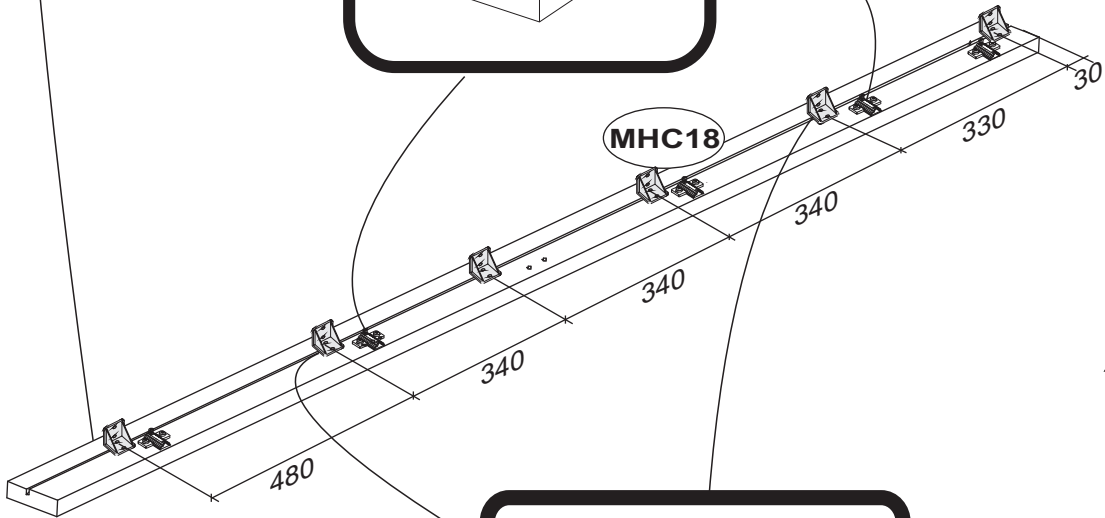
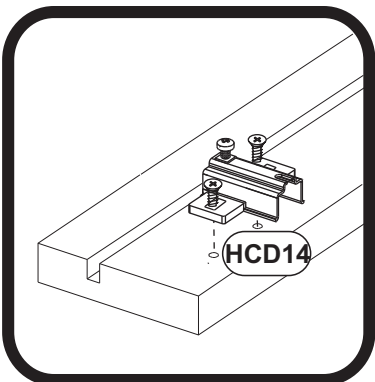
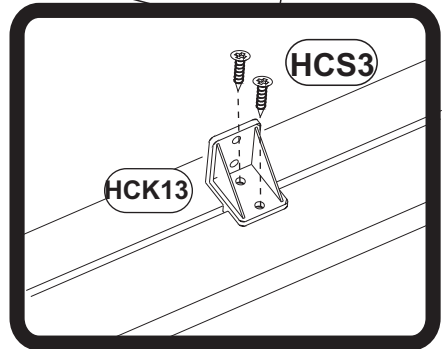
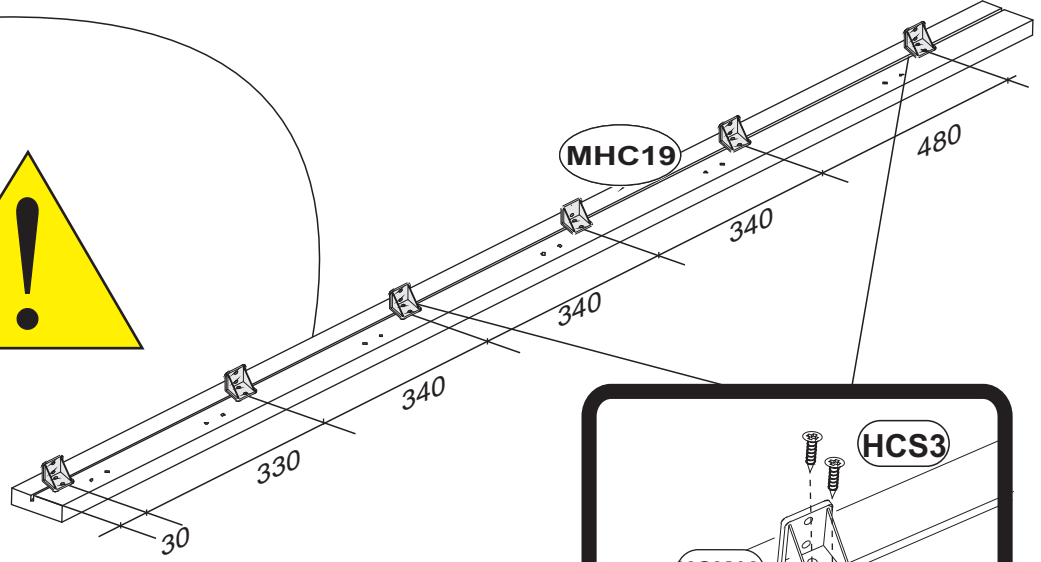
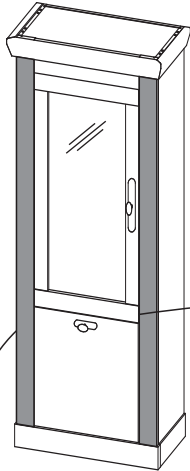
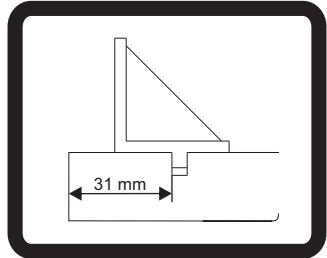

5

OPTION R

OPTION R



HCK13		49716	x12
HCD14		23515	x5
HCS3		1011	3,5x13 x24

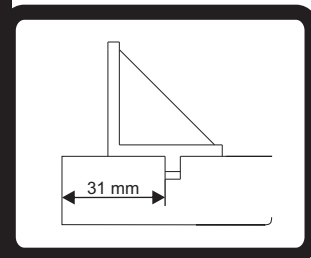
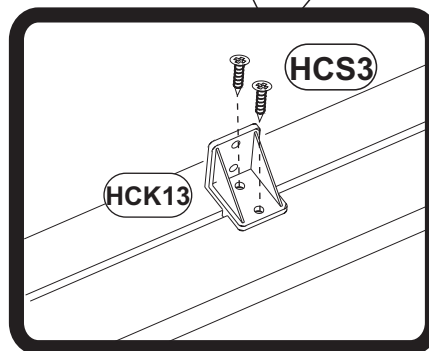
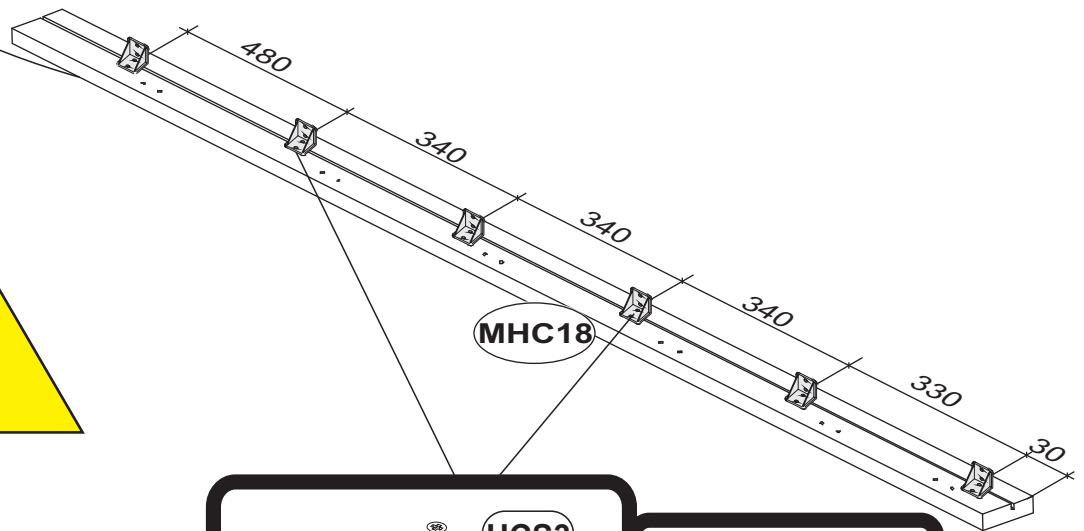
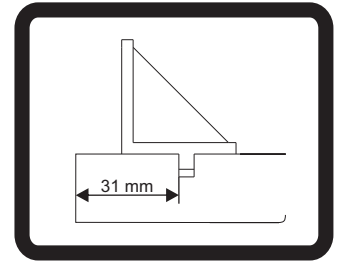
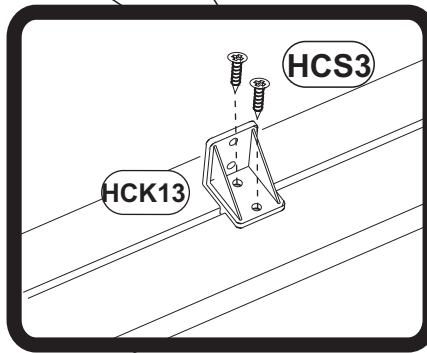
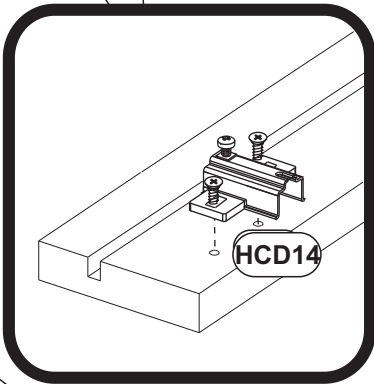
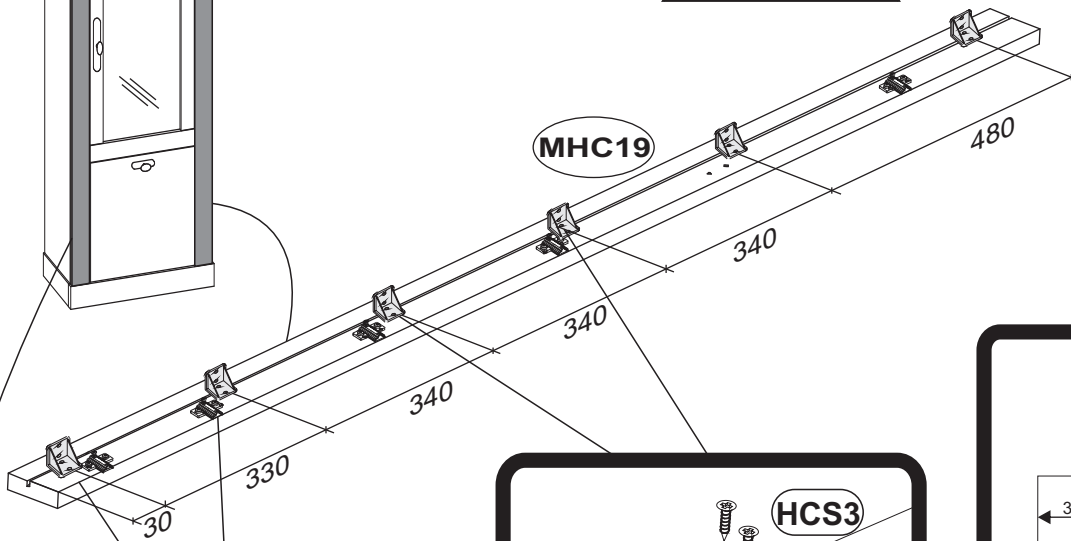
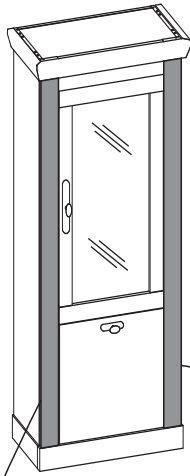

6

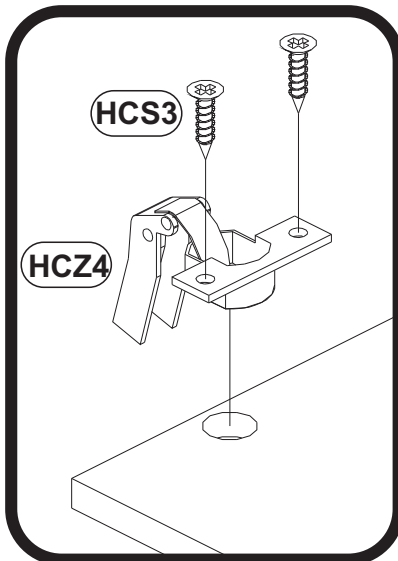
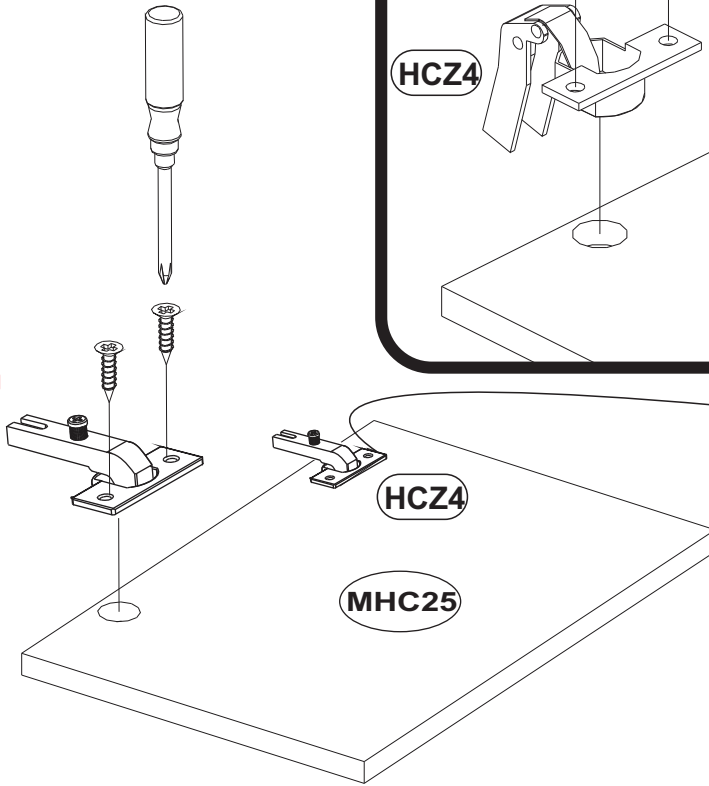
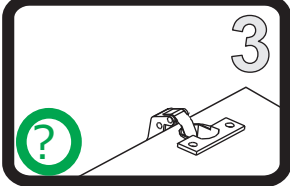
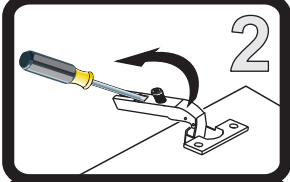
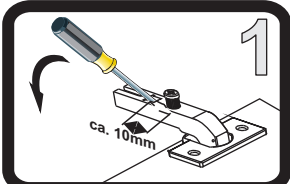
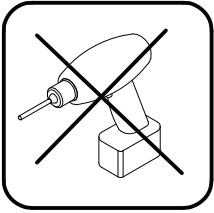

- HCZ4** 49365
φ35 90° x5
- HCS3** 1011
3,5x13 x10
- HCF44** 116795
x2
- HCG5** 1356
x16
- HCS11** 1073
3x16 x16

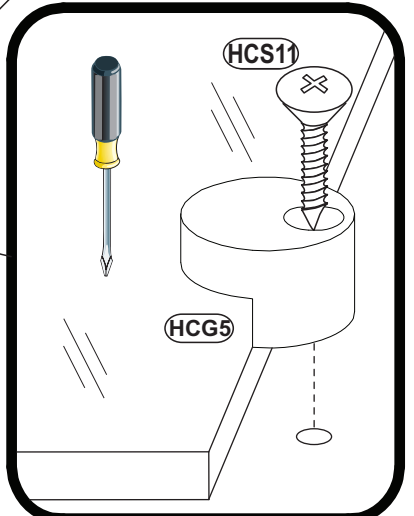
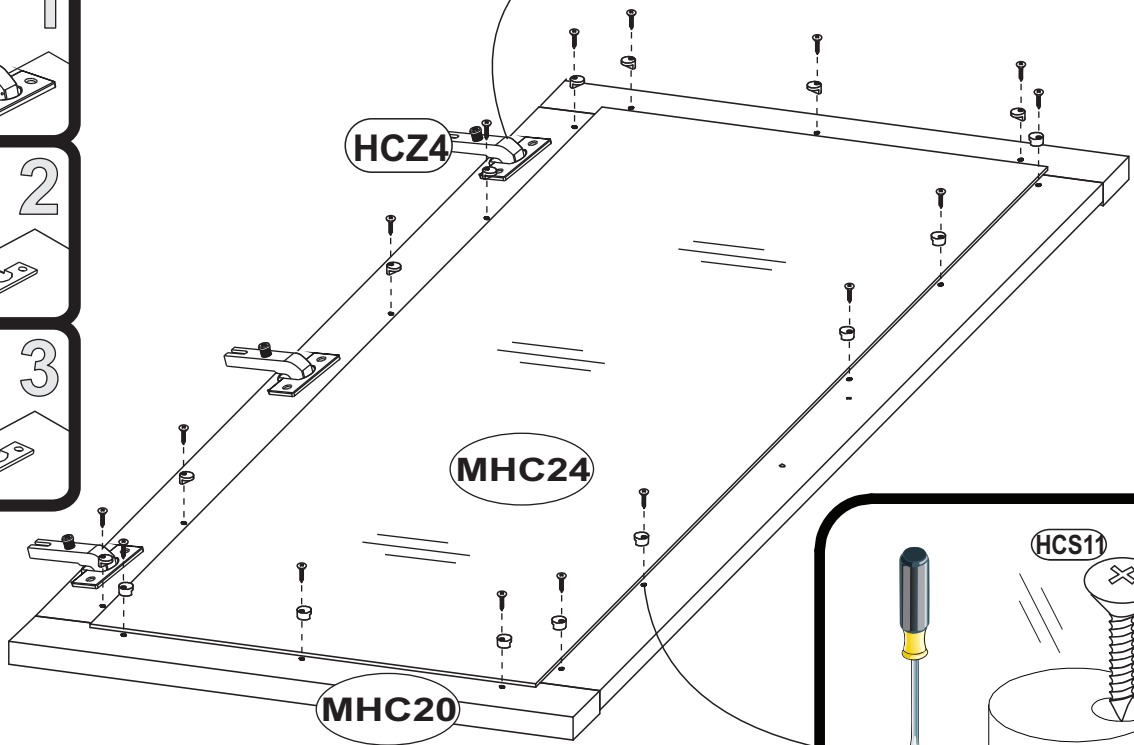
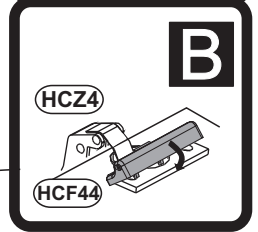

7

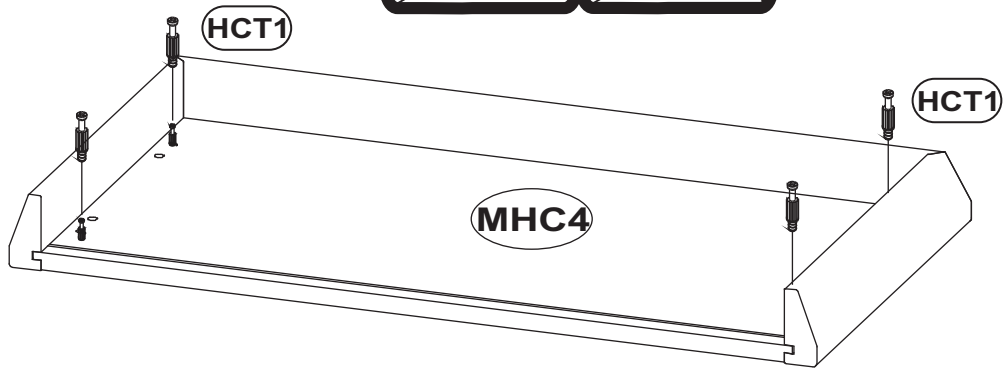
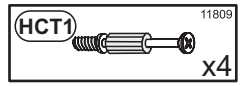
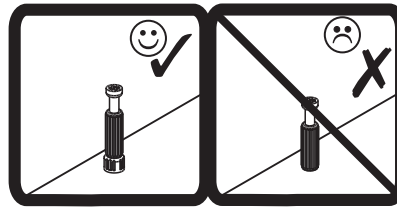

8

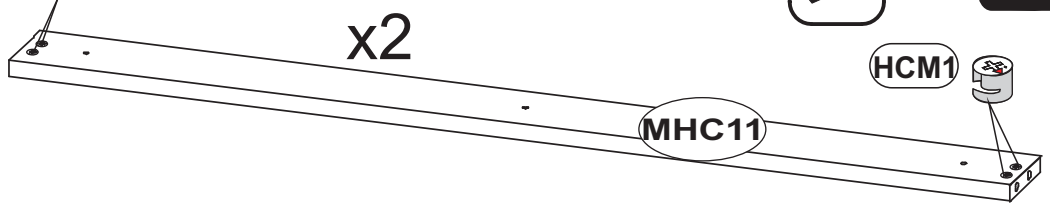
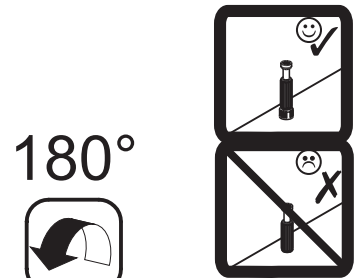
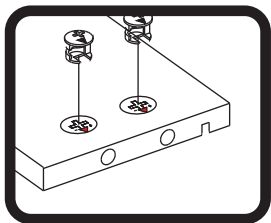
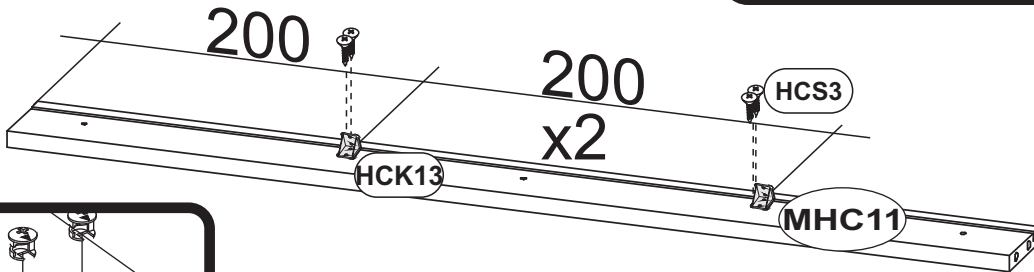
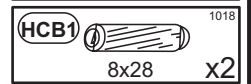
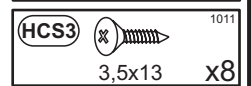
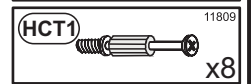
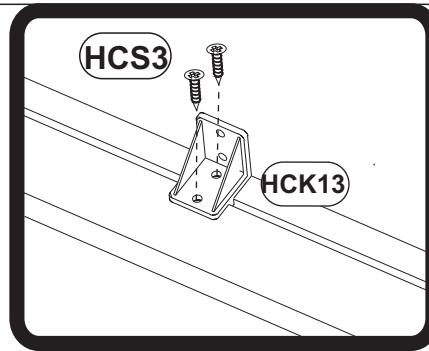
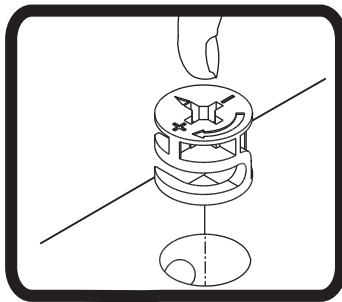

HCT1

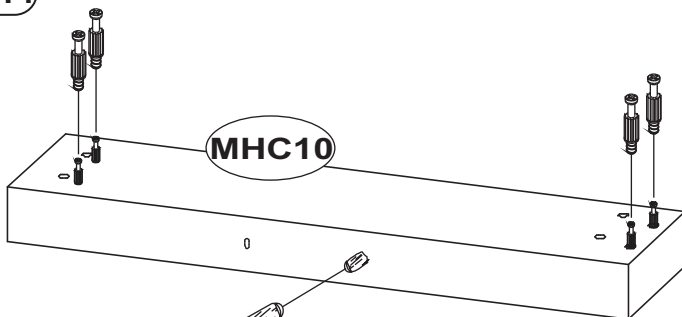

HCT1

HCT1

HCB1

HCT1

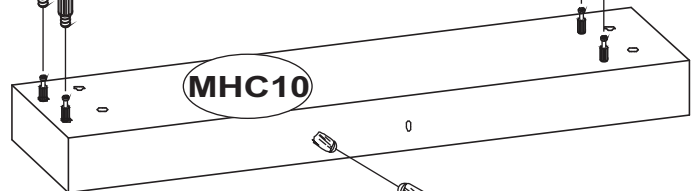

HCB1

9

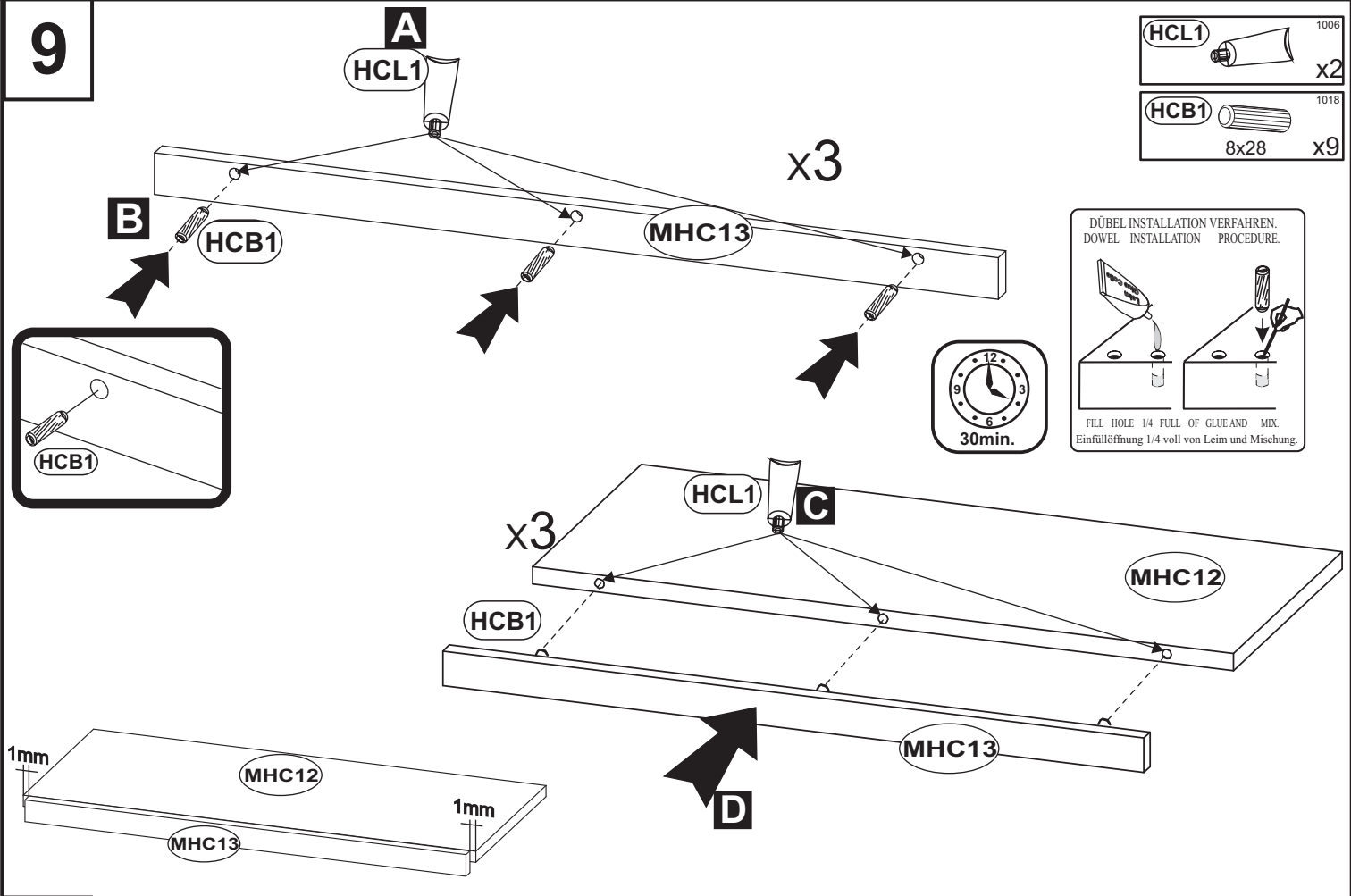

10

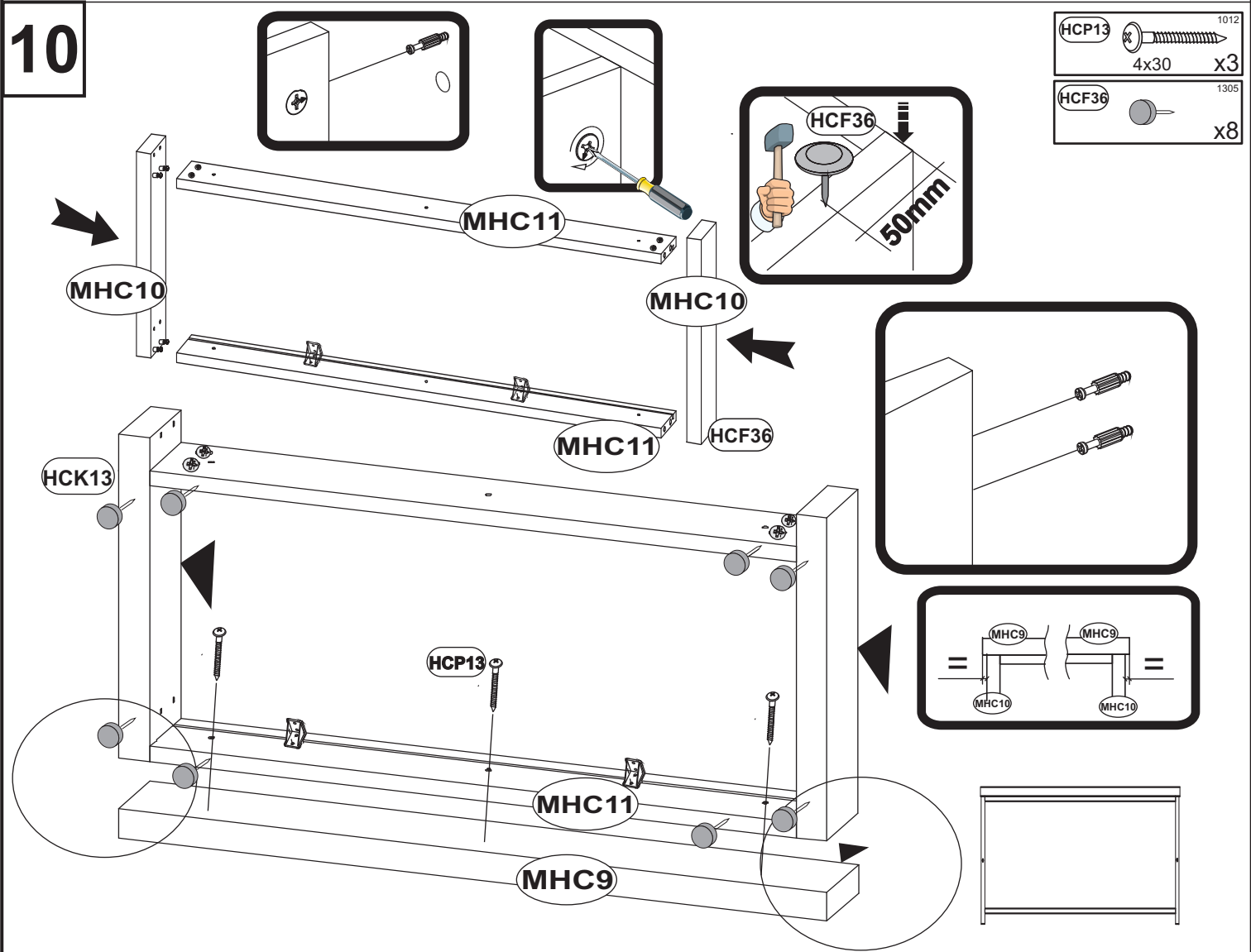

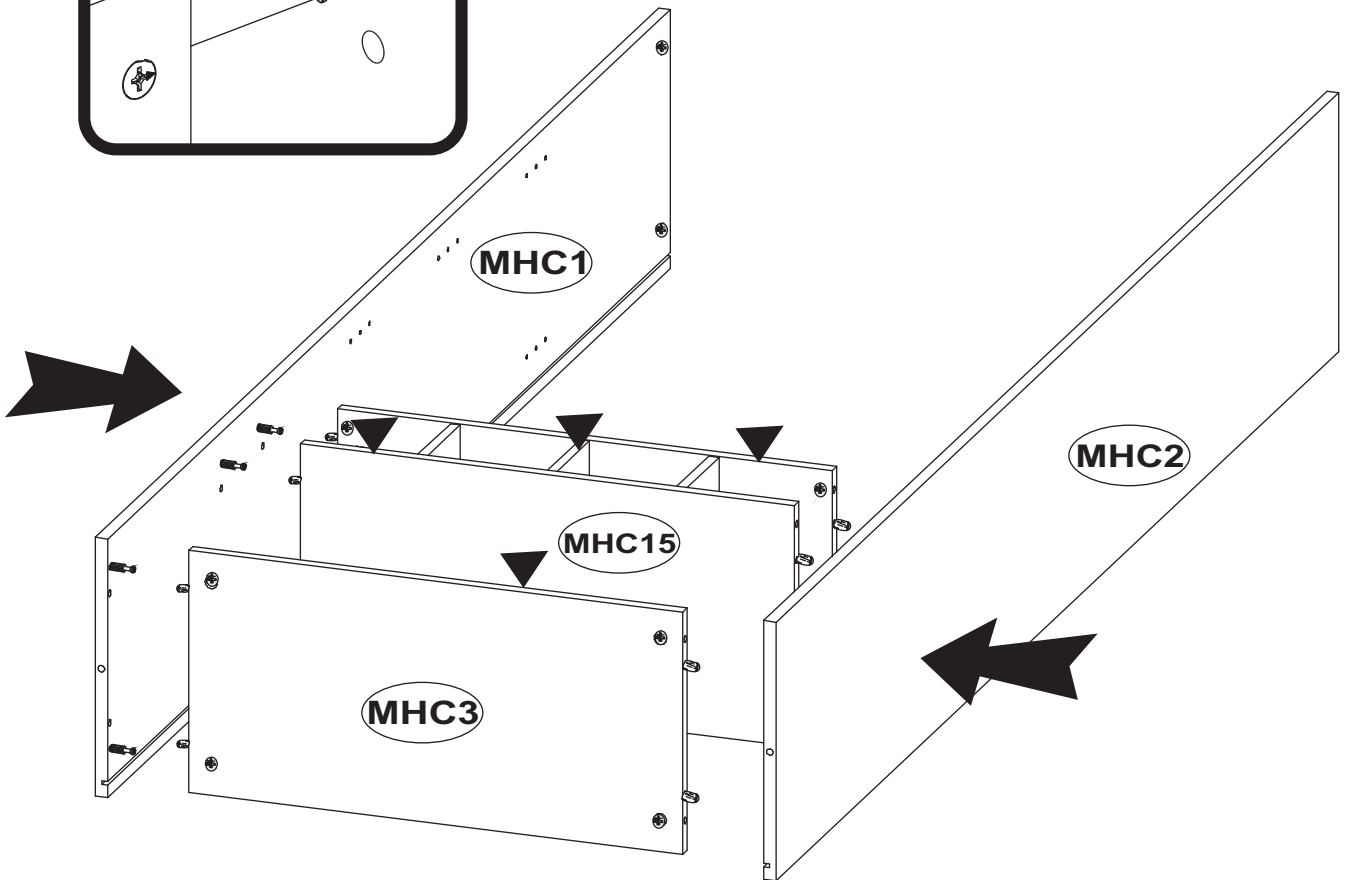
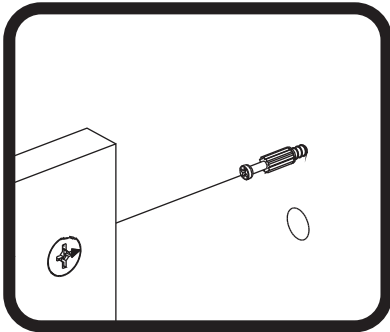
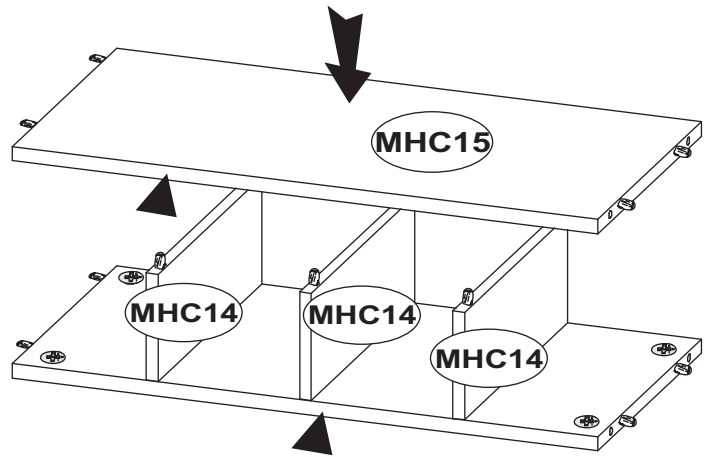
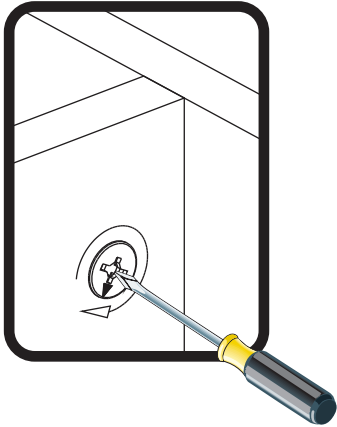
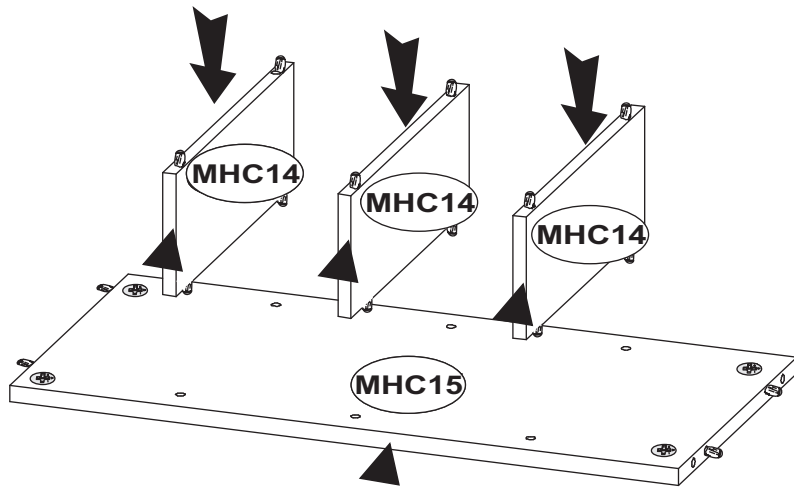



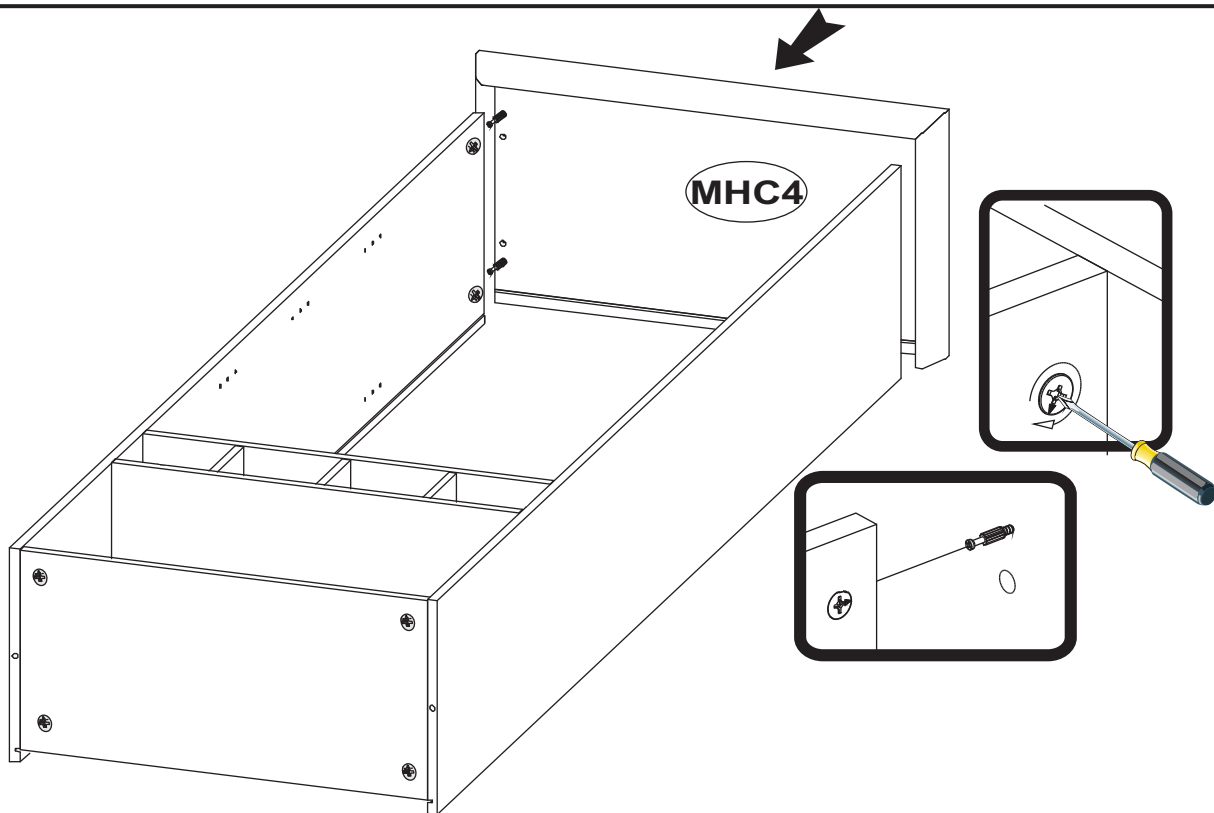

12

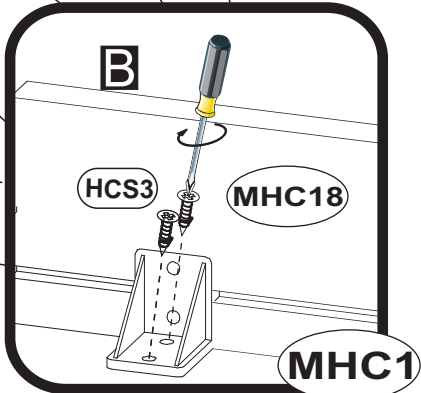
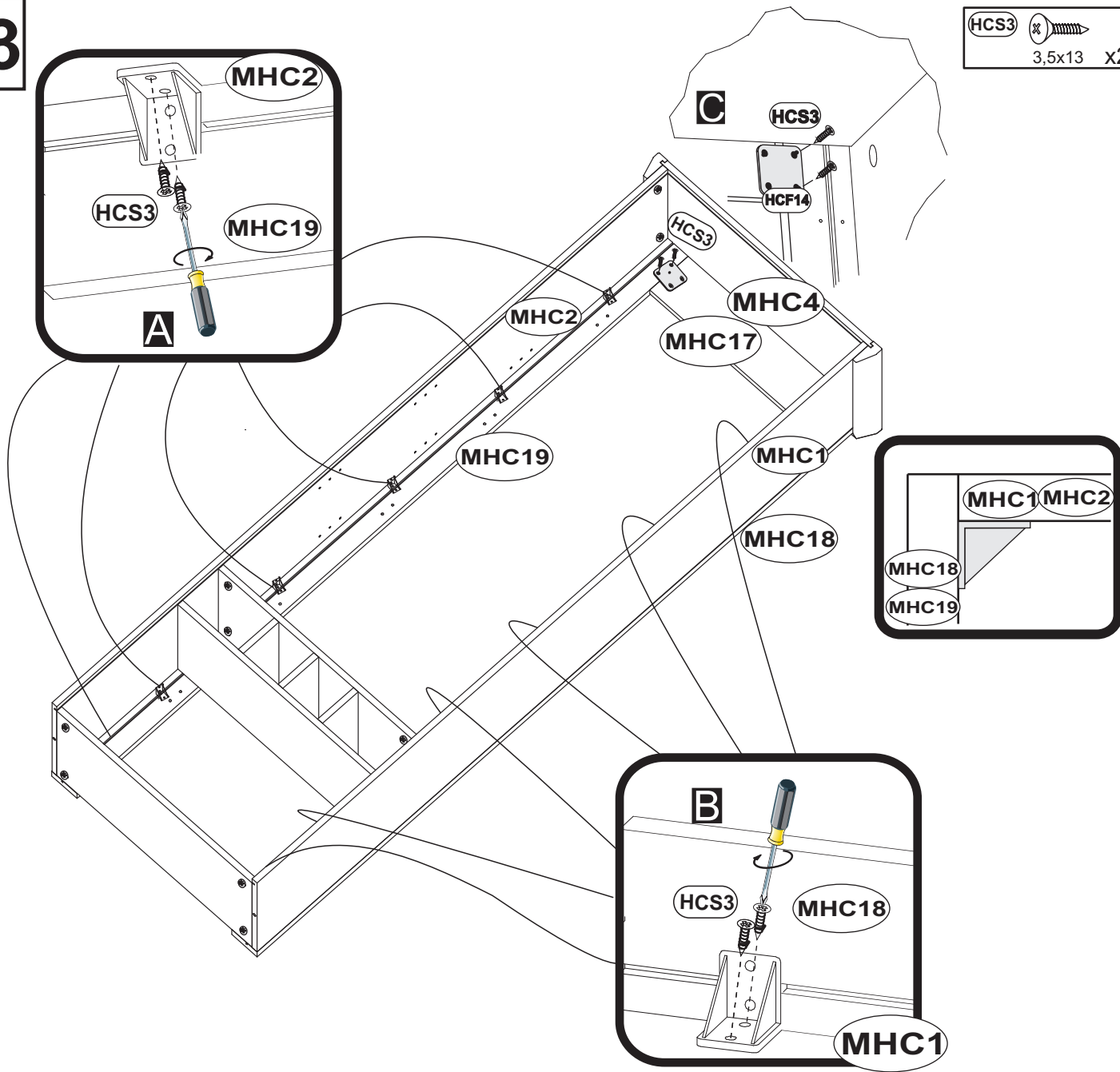
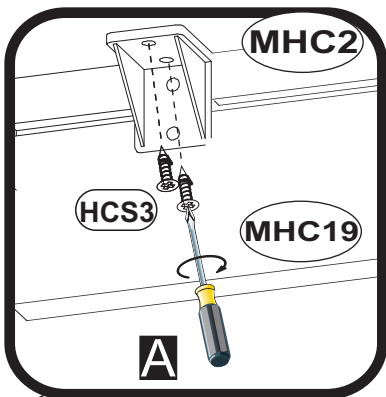

13

HCS3  1011
3,5x13 x28



HCJ23		1302
		x14
HCF1		1415
		x4
HCP6		1056
	3x20	x8

B

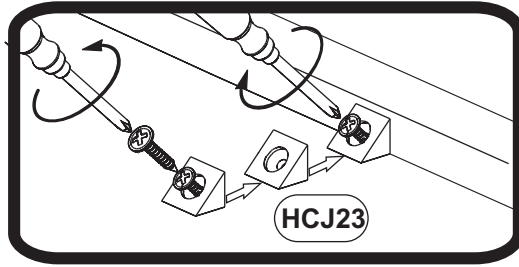

A

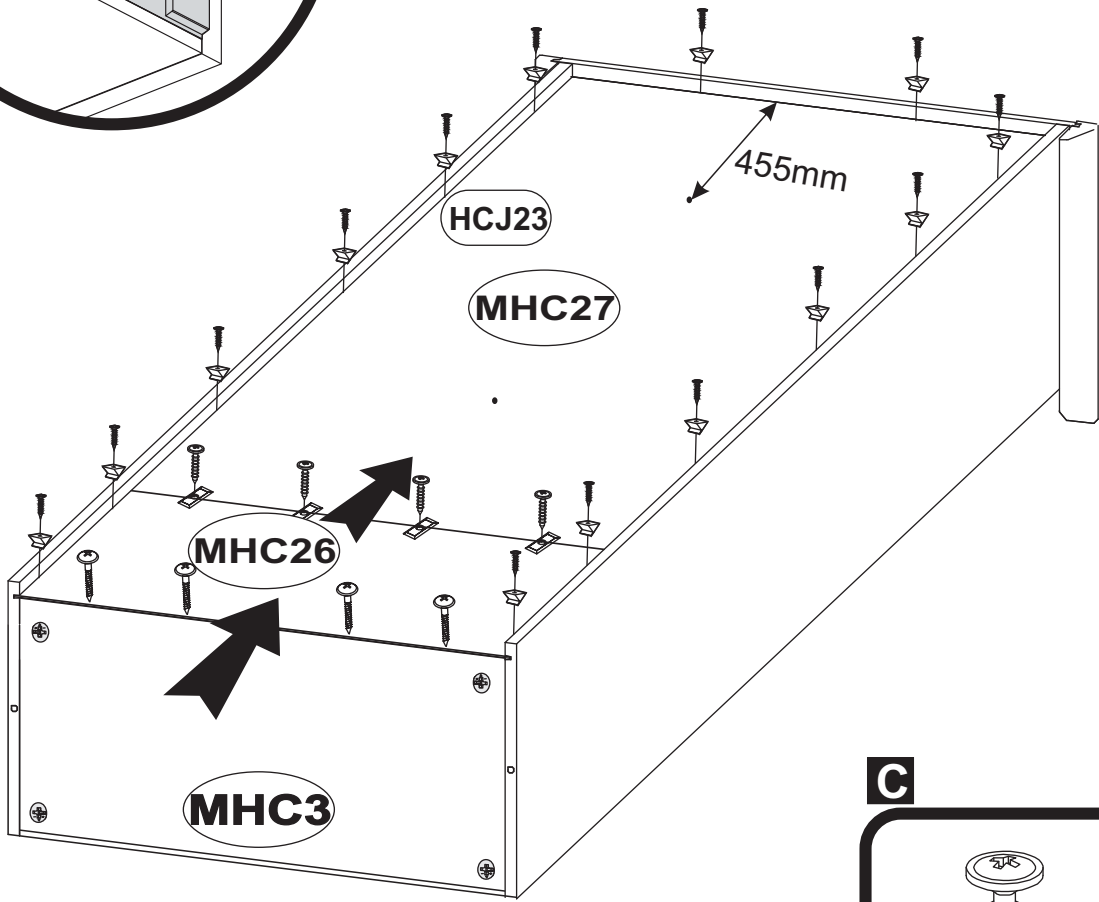
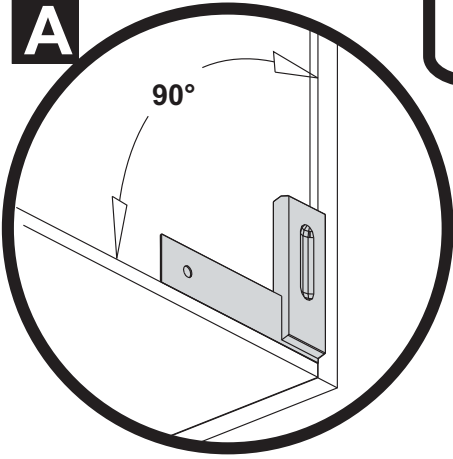

C

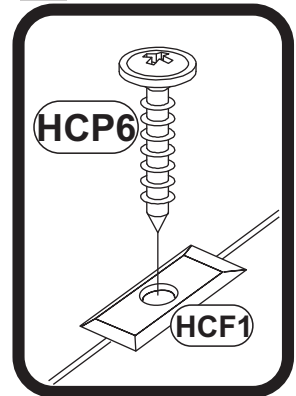

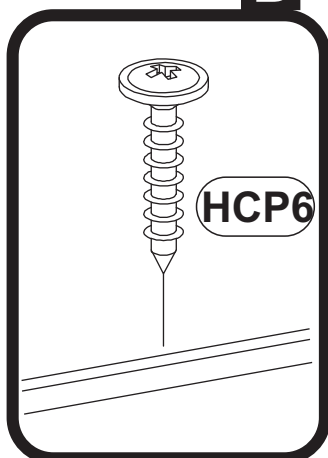

D

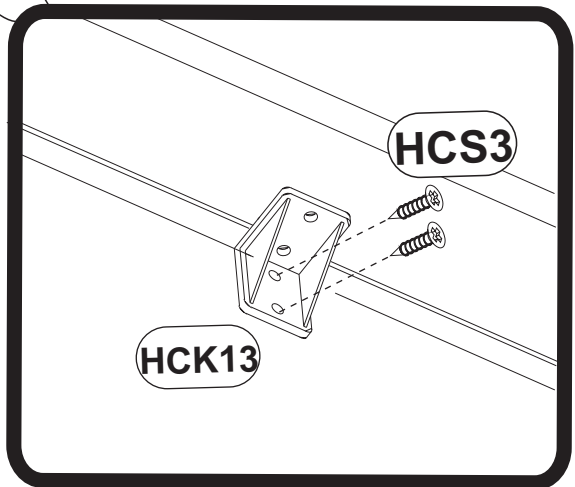
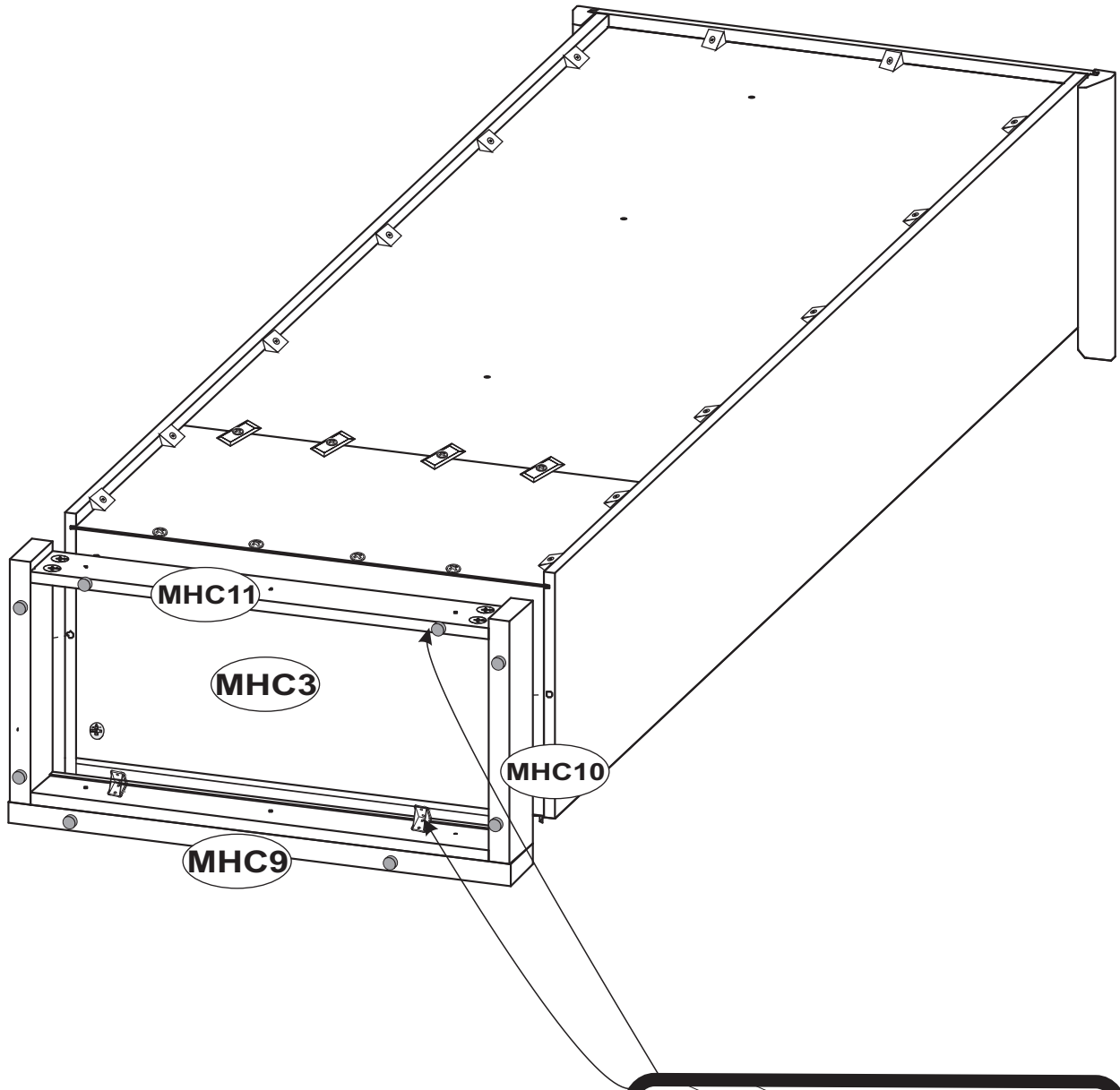



16

Option Left

HCG54		126680	x1
HCP2		1014	x1
		3,5x13	x1

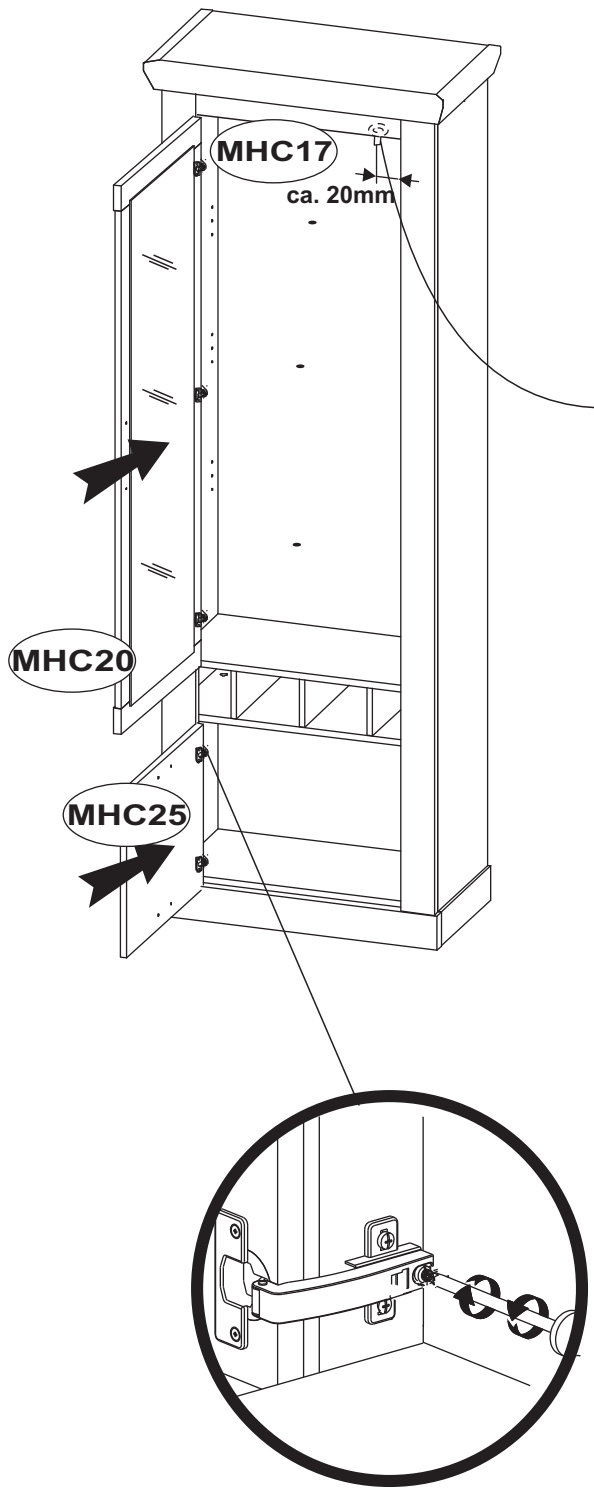

Option Right

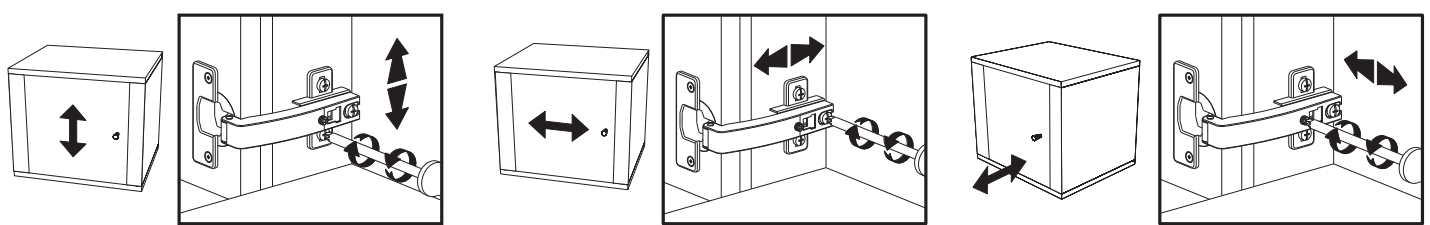
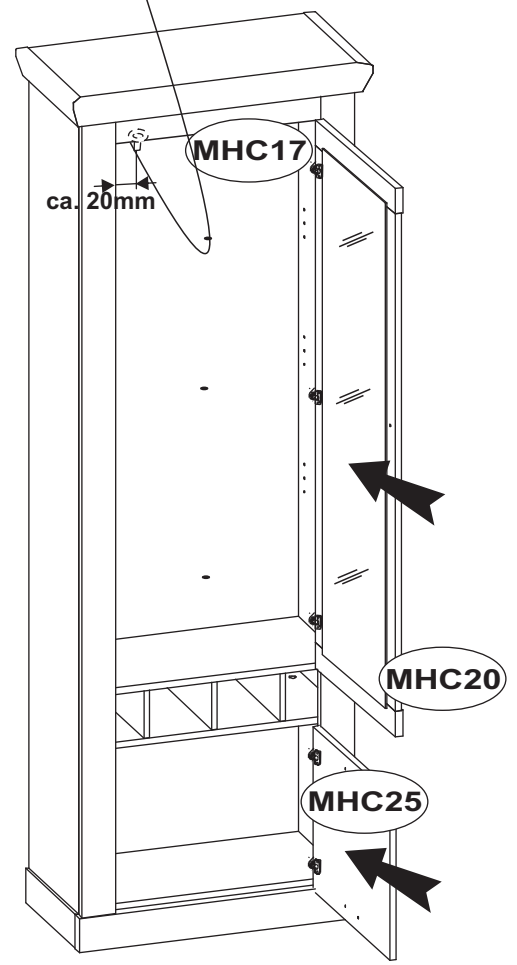

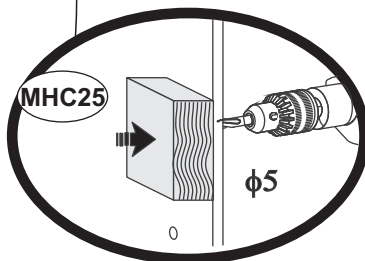
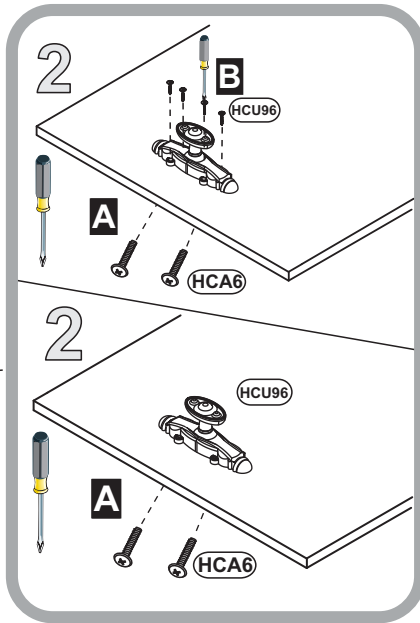
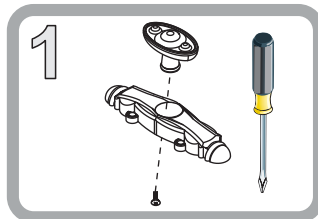
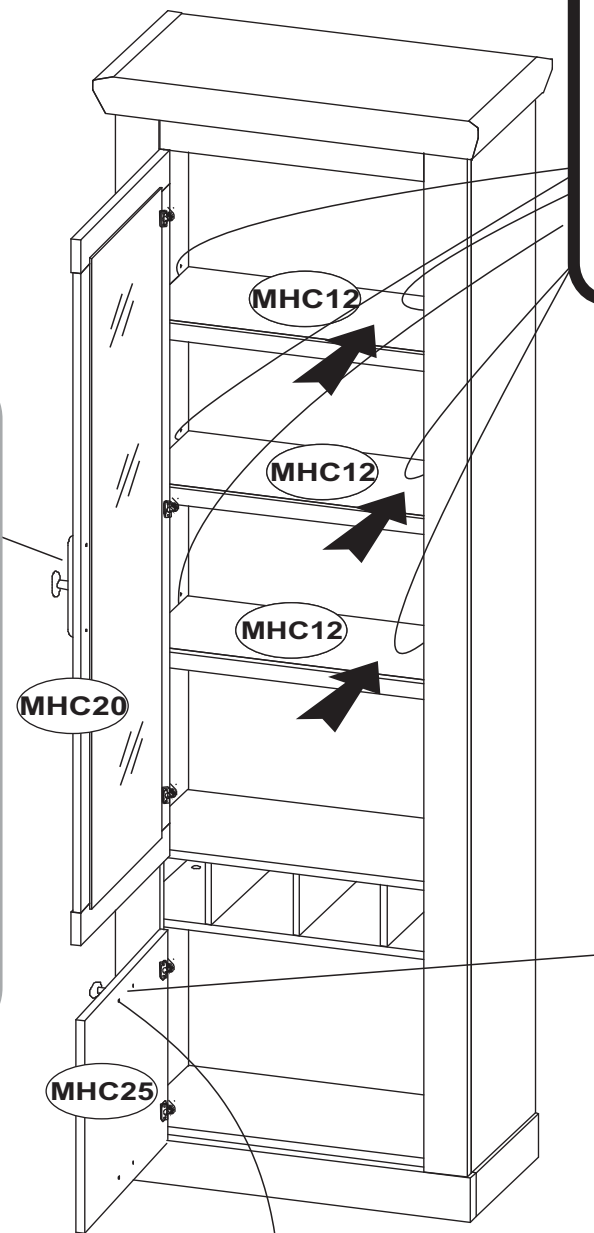
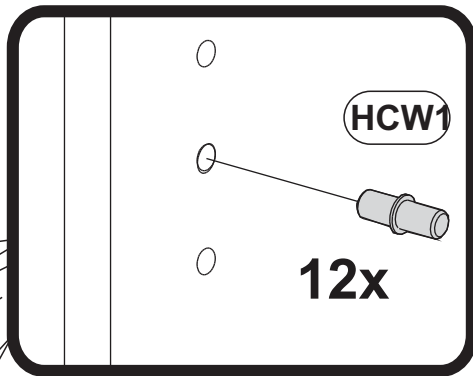
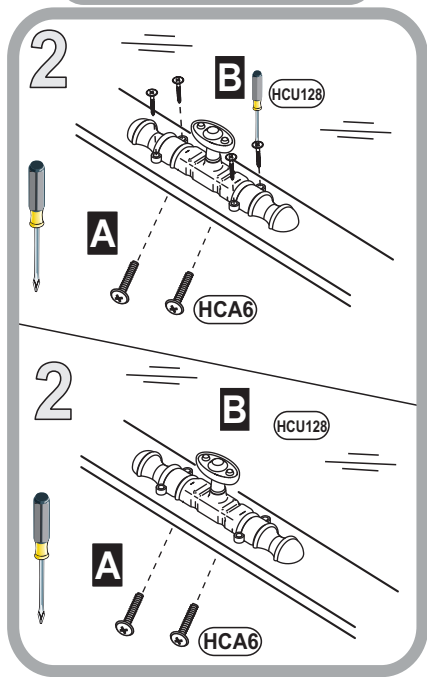
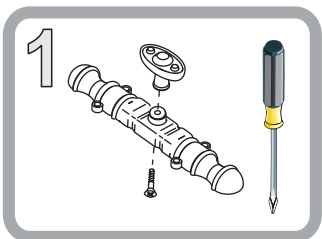
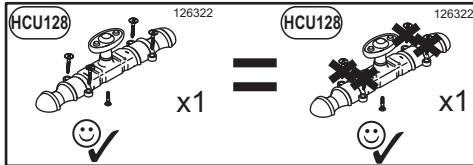
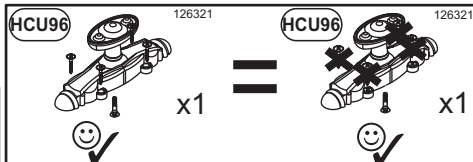
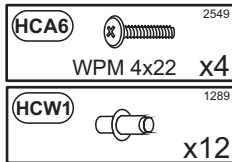

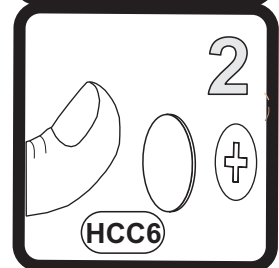
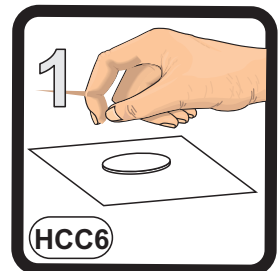
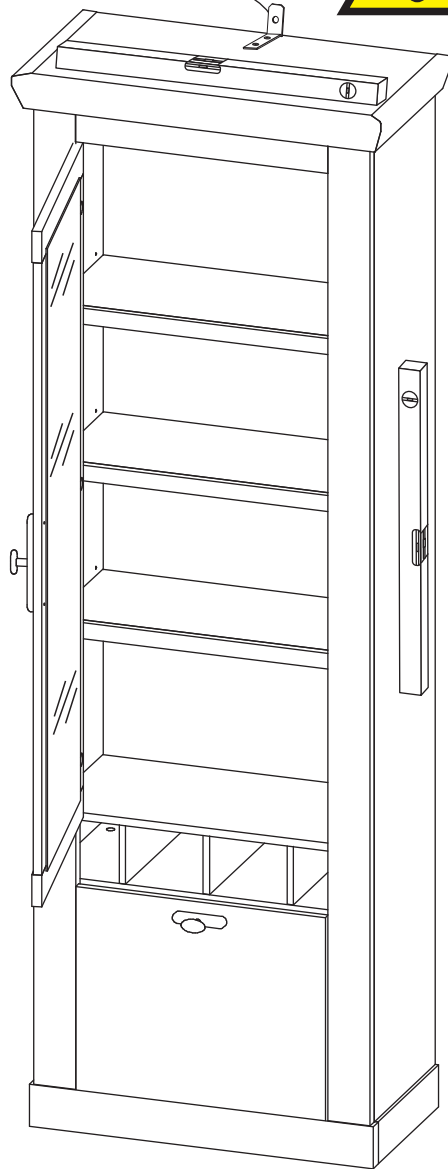
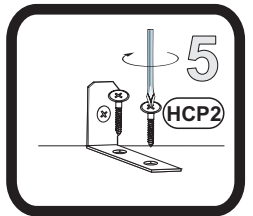
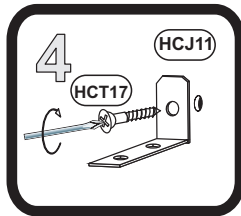
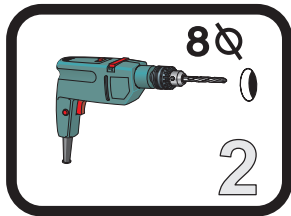
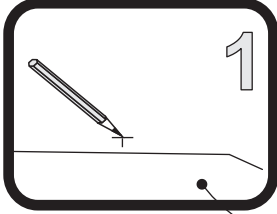
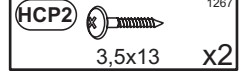
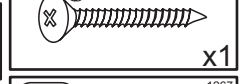
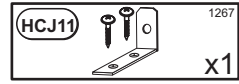
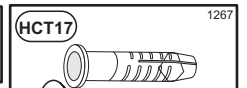
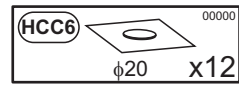
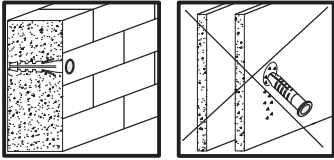

FLORENZ 23M

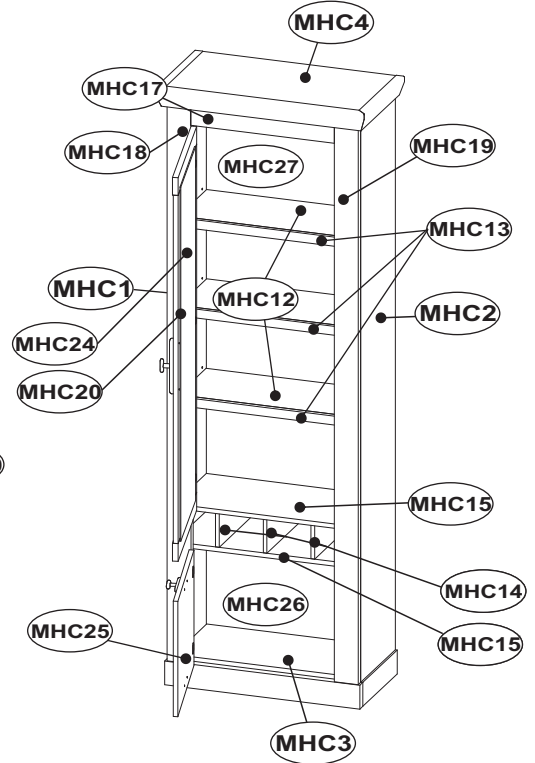
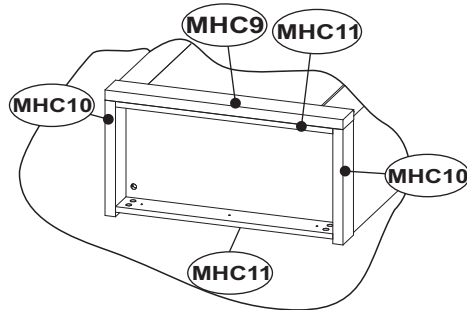

D Unser Direktservice für Beschlagteile
Sollte Ihnen ein Beschlagteil fehlen, können Sie diese Servicekarte direkt an die untenstehende Adresse mailen. Wir können allerdings nur Beschlagteile auf diesem Wege verschicken. Sollten Sie eine andere Beanstandung an Ihrem Möbelstück haben, so wenden Sie sich bitte direkt an Ihr Möbelhaus.

GB Our direct order service for fittings
If a fitting part is missing, you can e-mail this service card directly to the address below. However, we can only send fitting parts in this way. If you have any other cause for complaint concerning your item of furniture, please contact your furniture store directly.

CZ Naše přímé služby pro kování
Chybí-li vám nějaký díl z kování, můžete tuto servisní kartu odeslat e-mailem přímo na níže uvedenou adresu. Touto cestou však můžeme zoslat jen díly kování. Pokud byste reklamovali jiný díl nábytku, obraťte se přímo na svého prodejce nábytku.

F Bien étudier la notice de montage
S'il vous manque une ferrure, veuillez envoyer directement la présente carte service à l'adresse e-mail indiquée ci-dessous. Cependant, ceci nous permet uniquement d'envoyer des ferrures. Pour tout autre type de réclamation concernant votre meuble, veuillez contacter directement votre magasin d'ameublement.

I Il nostro servizio diretto per l'ordine della ferramenta
Qualora Vi dovesse mancare un pezzo di fissaggio, allora Vi preghiamo di inviare questa carta di servizio immediatamente all'indirizzo sottostante. Possiamo inviare i pezzi di fissaggio solamente per mezzo di questo procedimento. Qualora doveste avere qualche altra reclamazione in merito al mobile, allora Vi preghiamo di rivolgerVi direttamente al Vostro Negozio di mobili.

BG Нашата директна услуга за обкове
Ако липсват части от комплекта, попълнете настоящата сервисна карта и ни я изпратете на e-mail адреса, посочен по-долу. По този начин можем да доставяме само липсващи елементи от обкова. Ако установите други дефекти по мебелите, Ви съветваме да се обърнете към мебелната къща/магазин, от който сте закупили стоката.

NL Onze directservice voor losse onderdelen
Wanneer er een onderdeel ontbreekt, kunt u deze servicekaart direct aan onderstaand e-mailadres sturen. Wij kunnen langs deze weg echter alleen beslagdelen versturen. Mocht u een ander probleem aan uw meubel hebben, verzoeken wij u contact op te nemen met uw meubeldealer.

PL Nasz bezpośredni serwis części montażowych
Jeżeli brakuje części koniecznych do montażu, prosimy o przesłanie nam niniejszej karty serwisowej na niżej podany adres e-mailowy. W ten sposób możemy przelać Państwu tylko brakujące części. W przypadku innych reklamacji dotyczących mebla, prosimy zgłosić się do salonu meblowego, w którym został dokonany zakup.

HR Servis za okove
U slučaju da nedostaje neki od dijelova molimo vas da na dolje navedenu mail adresu pošaljete ovaj servisni obvezac. Na ovaj način mogu se dostaviti samo okovi. U slučaju da imate dodatne prigovore vezane uz komad namještaja molimo vas da se obratite izravno trgovini namještaja gdje je isti kupljen.

HU Direktszolgálatunk vasalatók részénél
Ha hiányzik egy vasalató, ezt a kártyát közvetlenül elküldheti az alább található címre. Azonban csakis vasalatókat tudunk így küldeni. Amennyiben másfajta reklamáció áll fenn bútordarabját illetően, forduljon közvetlenül a bútörházhoz.

SK Naš priamy servis pre časti kovania
Ak by Vám chýbala nejaká časť kovania, môžete poslať túto servisnú kartu poslať e-mailom na nižšie uvedenú adresu. Diely kovania vieme poslať iba týmto spôsobom. Ak by ste mali inú reklamáciu ohľadom Vašho nábytku, obráťte sa priamo na Vašu predajňu nábytku.

SLO Naše direktne uslužne storitve za okovje
Če vam manjka kakšno okovje, lahko to servisno kartico pošljete po e-pošti direktno na spodnji naslov. Po tej poti vam lahko pošljemo samo okovje. Če želite reklamirati kakšen drug del pohištva, se obrnite neposredno na vašo trgovino pohištva.

RO Service-ul nostru direct pentru feronerie
În cazul în care vă lipsește o piesă de feronerie puteți să trimiteți direct acest card de service prin e-mail la adresa de mai jos. Noi nu putem expedia piese de feronerie decât pe această cale. Dacă aveți o altă reclamație referitoare la piesa de mobilier, atunci vă rugăm să vă adresați direct la magazinul dvs. de mobilă.

RUS Наш прямой сервис для поставок фурнитуры
Если окажется, что Вам не хватает того или иного элемента фурнитуры, Вы можете отправить сервисную карту по факсу непосредственно на нижеприведенный адрес электронной почты. Однако, таким образом мы можем переслать лишь фурнитуру. Если же у Вас возникнут иные претензии относительно приобретенной мебели, пожалуйста, обращайтесь непосредственно в организацию, осуществлявшую продажу.

S Vår direktservice för beslagsdelar
Om du saknar en beslagsdel kan du skicka detta servicekort direkt till e-postadressen som anges nedan. Tänk på att detta är den enda möjligheten att skicka beslagsdelar till dig. Om du vill reklamera din möbel av en annan anledning måste du kontakta ditt möbelhus direkt.

ES Nuestro servicio directo para accesorios
Si le falta algún accesorio, puede enviar esta tarjeta de servicio directamente a la siguiente dirección. No obstante, por este método solo podemos enviar accesorios. Si tiene alguna otra objeción sobre su mueble, consulte directamente con su mueblería.

TR Donatılar için doğrudan servisimiz
Bir donatınız eksikse bu servis kartını doğrudan aşağıda bulunan adrese doğrudan mail yazabilirsiniz. Sadece bu yolla donatılar gönderilebilir. Mobilyanızda başka şikayetleriniz varsa lütfen doğrudan mobilya satıcınıza danışın.

MHC1	1911	320	15	2/2	MHC17	483	120	18	2/2
MHC2	1911	320	15	2/2	MHC18	1911	80	22	2/2
MHC3	611	299	15	1/2	MHC19	1911	80	22	2/2
MHC4	699	370,5	65	1/2	MHC20	1279	477	18	2/2
MHC9	655	80	28	1/2	MHC24	1189	386	4	2/2
MHC10	317	80	28	1/2	MHC25	388	477	15	2/2
MHC11	598	80	15	1/2	MHC26	385	623	3	2/2
MHC12	610	267	15	1/2	MHC27	1531	623	3	2/2
MHC13	608	30	16	1/2					
MHC14	112	298	15	1/2					
MHC15	611	299	15	1/2					

FLORENZ 23M

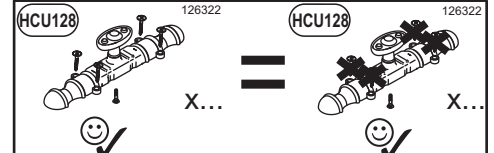
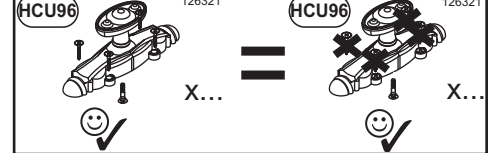
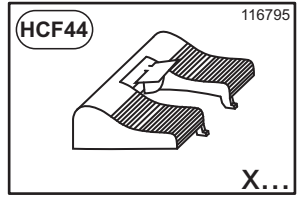
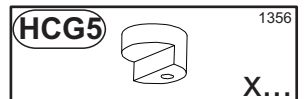
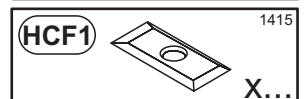
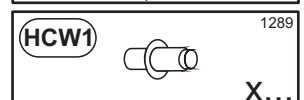
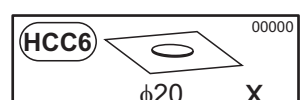
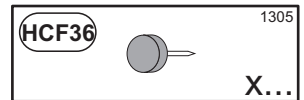
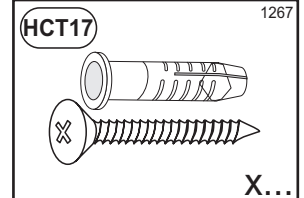
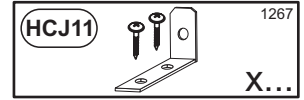
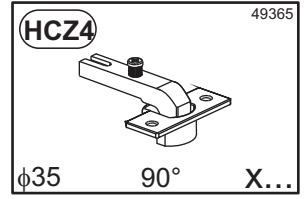
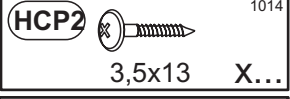
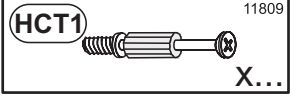
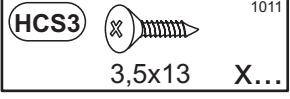
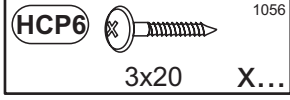
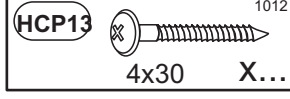
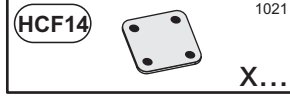
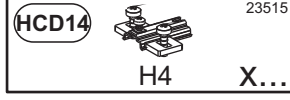
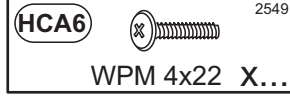
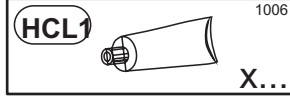
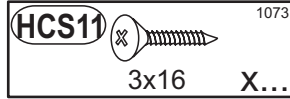
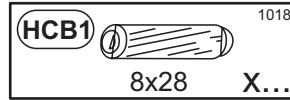
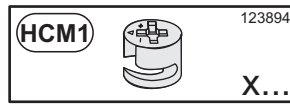

D Unser Direktservice für Beschlagteile
Sollte Ihnen ein Beschlagteil fehlen, können Sie diese Servicekarte direkt an die untenstehende Adresse mailen. Wir können allerdings nur Beschlagteile auf diesem Wege verschicken. Sollten Sie eine andere Beanspruchung an Ihrem Möbelstück haben, so wenden Sie sich bitte direkt an Ihr Möbelhaus.

GB Our direct order service for fitting
If a fitting part is missing, you can e-mail this service card directly to the address below. However, we can only send fitting parts in this way. If you have any other cause for complaint concerning your item of furniture, please contact your furniture store directly.

CZ Naše přímé služby pro kování
Chybí-li vám nějaký díl z kování, můžete tuto servisní kartu odeslat e-mailem přímo na níže uvedenou adresu. Touto cestou však můžeme zoslat jen díly kování. Pokud byste reklamovali jiný díl nábytku, obraťte se přímo na svého prodejce nábytku.

F Bien étudier la notice de montage
S'il vous manque une ferrure, veuillez envoyer directement la présente carte service à l'adresse e-mail indiquée ci-dessous. Cependant, ceci nous permet uniquement d'envoyer des ferrures. Pour tout autre type de réclamation concernant votre meuble, veuillez contacter directement votre magasin d'ameublement.

I Il nostro servizio diretto per l'ordine della ferramenta
Qualora Vi dovesse mancare un pezzo di fissaggio, allora Vi preghiamo di inviare questa carta di servizio immediatamente all'indirizzo sottostante. Possiamo inviare i pezzi di fissaggio solamente per mezzo di questo procedimento. Qualora dovesse avere qualche altra reclamazione in merito al mobile, allora Vi preghiamo di rivolgerVi direttamente al Vostro Negozio di mobili.

BG Нашата директна услуга за обкова
Ако липсват части от комплекта, попълнете настоящата сервисна карта и ни я изпратете на e-mail адреса, посочен по-долу. По този начин можем да доставим само липсващи елементи от обкова. Ако установите други дефекти по мебелите, Ви съветваме да се обърнете към мебелната къща/магазин, от който сте закупили стоката.

NL Onze directservice voor losse onderdelen
Wanneer er een onderdeel ontbreekt, kunt u deze servicekaart direct aan onderstaand e-mailadres sturen. Wij kunnen langs deze weg echter alleen beslagdelen versturen. Mocht u een ander probleem aan uw meubel hebben, verzoeken wij u contact op te nemen met uw meubeldealer.

PL Nasz bezpośredni serwis czeski montażowych
Jeżeli brakuje części koniecznych do montażu, prosimy o przesłanie nam niniejszej karty serwisowej na niżej podany adres e-mailowy. W ten sposób możemy przelać Państwu tylko brakujące części. W przypadku innych reklamacji dotyczących mebla, prosimy zgłosić się do salonu meblowego, w którym został dokonany zakup.

HR Servis za okove
U slučaju da nedostaje neki od dijelova molimo vas da na dolje navedenu mail adresu pošaljete ovaj servisni obrazac. Na ovaj način mogu se dostaviti samo okovi. U slučaju da imate dodatne prigovore vezane uz komad namještaja molimo vas da se obratite izravno trgovini namještaja gdje je isti kupljen.

HU Direktszolgálatunk vasalatok esetén
Ha hiányzik egy vasalatk, ezt a kártyát közvetlenül elküldheti az alább található címre. Azonban csakis vasalatoskat tudunk így küldeni. Amennyiben másfajta reklamáció áll fenn bútoráruházt illetően, forduljon közvetlenül a bútorházhöz.

SK Naš priamy servis pre časti kovania
Ak by Vám chýbala nejaká časť kovania, môžete poslať túto servisnú kartu pošlat e-mailom na nižšie uvedenú adresu. Díly kovania vieme poslať iba týmto spôsobom. Ak by ste mali inú reklamáciu ošhadom Vášho nábytku, obráťte sa priamo na Vašu predajňu nábytku.

SLO Naše direktne uslužne storitve za okovje
Če vam manjka kakšno okovje, lahko to servisno kartico pošljete po e-pošti direktno na spodnji naslov. Po taj poti vam lahko pošljemo samo okovje. Če želite reklamirati kakšen drug del pohištva, se obrnite neposredno na vašo trgovino pohištva.

RO Service-ul nostru direct pentru feronerie
În cazul în care vă lipsește o piesă de feronerie puteți să trimiteți direct acest card de service prin e-mail la adresa de mai jos. Noi nu putem expedia piese de feronerie decât pe această cale. Dacă aveți o altă reclamație referitoare la piesa de mobilier, atunci vă rugăm să vă adresați direct la magazinul dvs. de mobilier.

RUS Наш прямой сервис для поставок фурнитур
Если окажется, что Вам не хватает того или иного элемента фурнитуры, Вы можете отправить сервисную карту по факсу непосредственно на нижеприведенный адрес электронной почты. Однако, таким образом мы можем пересылать лишь фурнитуру. Если же у Вас возникнут иные претензии относительно приобретенной мебели, пожалуйста, обращайтесь непосредственно в организацию, осуществившую продажу.

S Vi direktservice för beslagsdelar
Om du saknar en beslagsdel kan du skicka detta servicekort direkt till e-postadressen som anges nedan. Tänk på att detta är den enda möjligheten att skicka beslagsdelar till dig. Om du vill reklamera din möbel av en annan anledning måste du kontakta ditt möbelhus direkt.

ES Nuestro servicio directo para accesorios
Si le falta algún accesorio, puede enviar esta tarjeta de servicio directamente a la siguiente dirección. No obstante, por este método solo podemos enviar accesorios. Si tiene alguna otra objeción sobre su mueble, consulte directamente con su mueblería.

TR Donatılar için doğrudan servisimiz
Bir donatınız eksikse bu servis kartını doğrudan aşağıda bulunan adrese doğrudan mail yazabilirsiniz. Sadece bu yolla donatılar gönderiliriz. Mobilyanızda başka şikayetleriniz varsa lütfen doğrudan mobilya satıcınıza danışın.

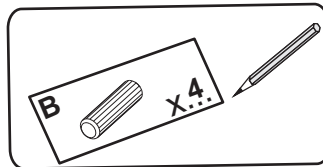

FLORENZ 31M

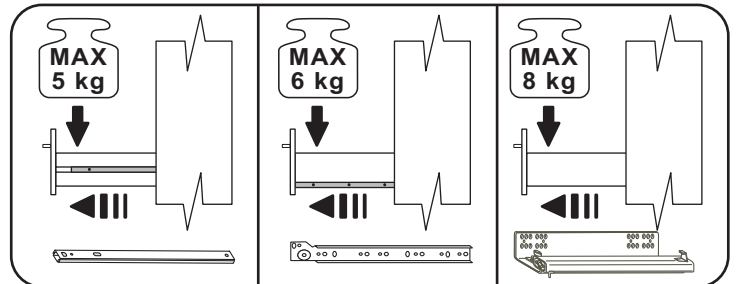
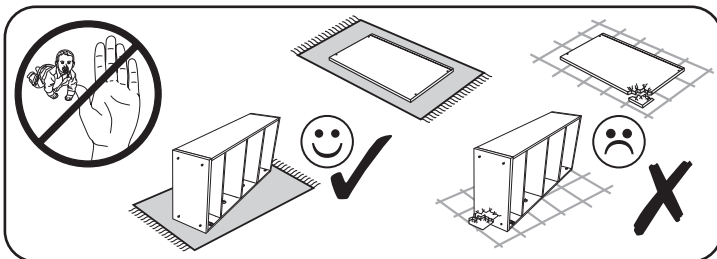
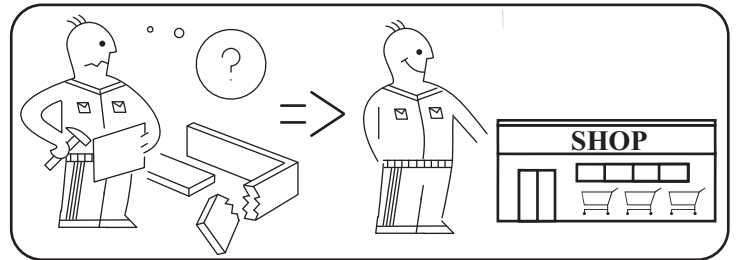
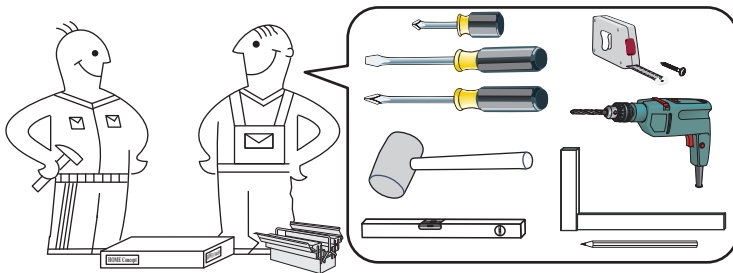
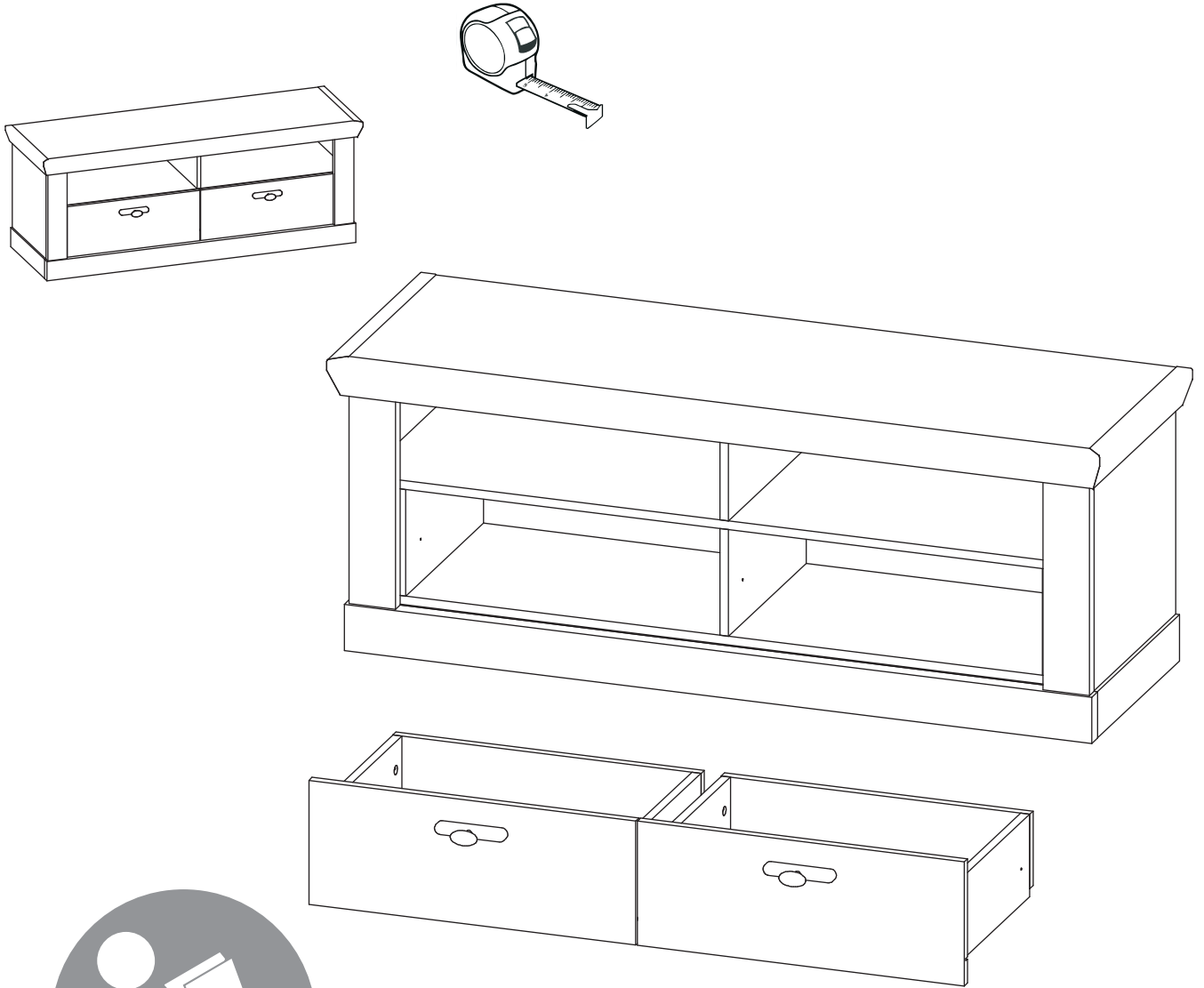

FLORENZ 31M

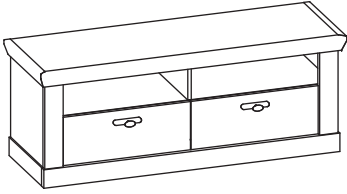

max.



MHC3

MHC4

max.



MHC8

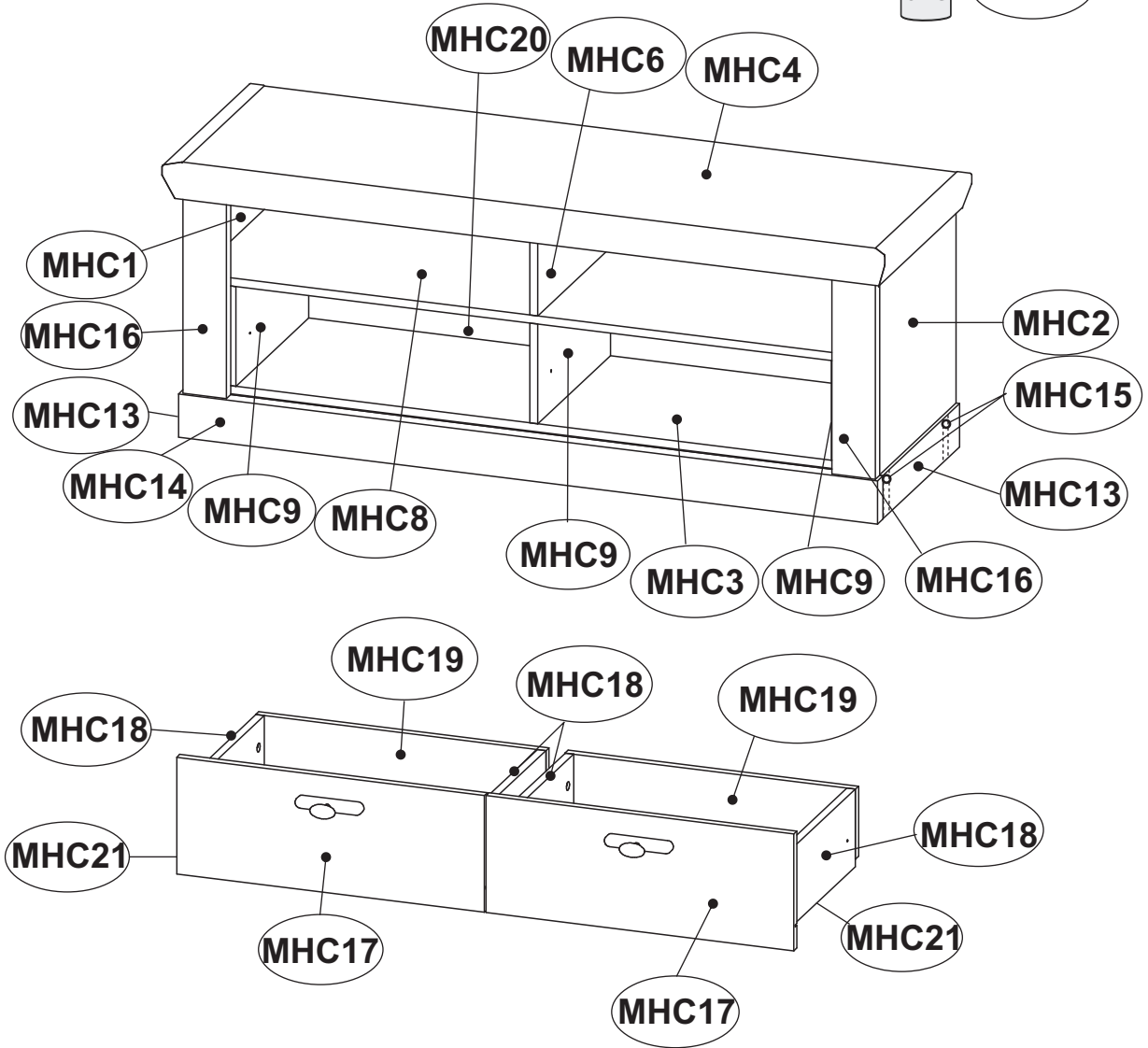



MHC1	411	389	15	1/1
MHC2	411	389	15	1/1
MHC3	1244	368	15	1/1
MHC4	1332	439,5	65	1/1
MHC6	196	367	15	1/1
MHC8	1244	368	15	1/1
MHC9	185	368	15	1/1
MHC13	386	80	28	1/1
MHC14	1288	80	28	1/1
MHC15	1231	80	15	1/1

MHC16	411	80	22	1/1
MHC17	553	210	15	1/1
MHC18	332	140	15	1/1
MHC19	522	126	15	1/1
MHC20	1256	416	3	1/1
MHC21	503	354	3	1/1

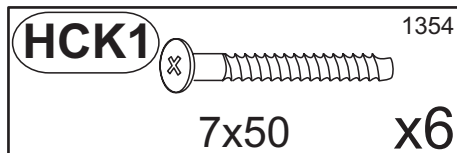
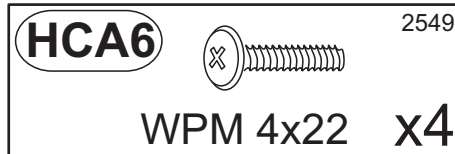
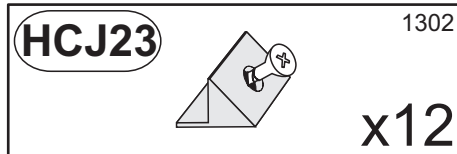
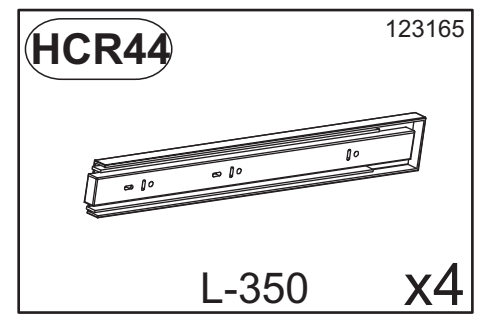
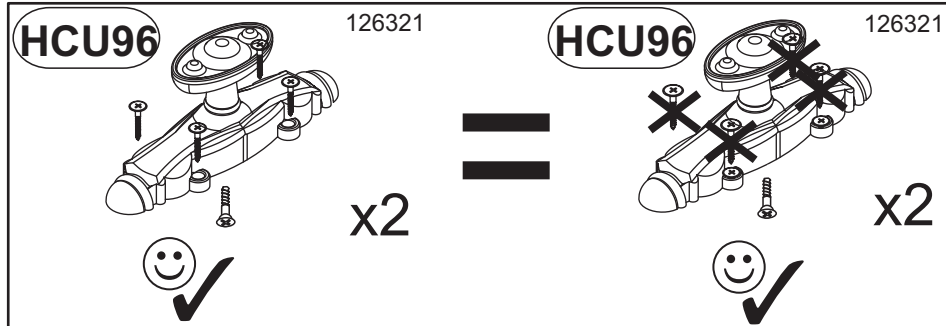
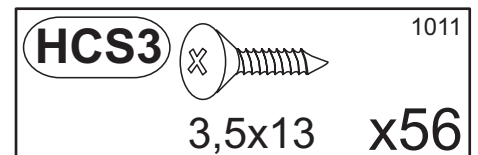
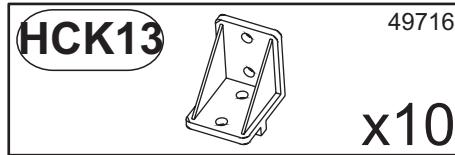
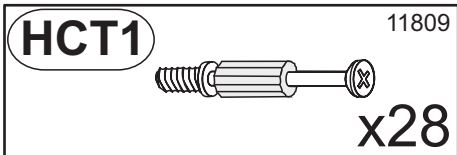
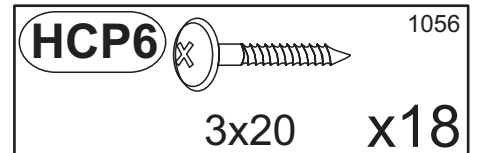
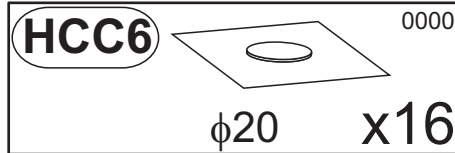
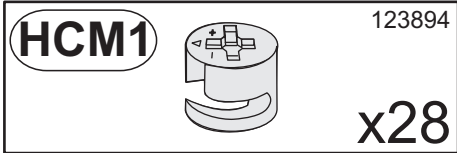
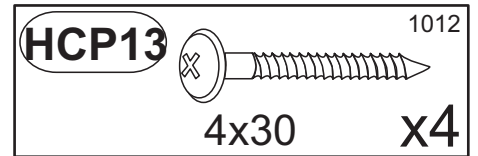
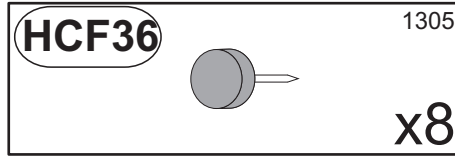
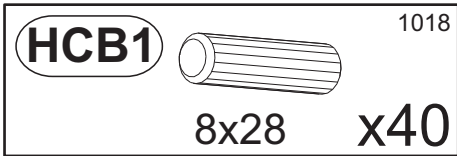
FLORENZ 31M

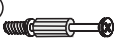

1

HCB1		1018
	8x28	x16
HCM1		123894
		x8
HCT1		11809
		x8

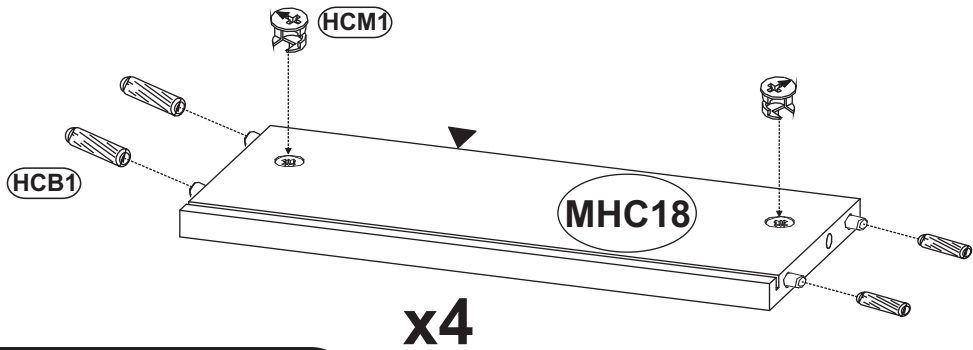

x4

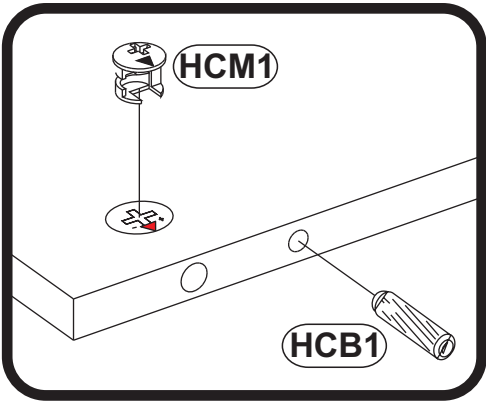

x2

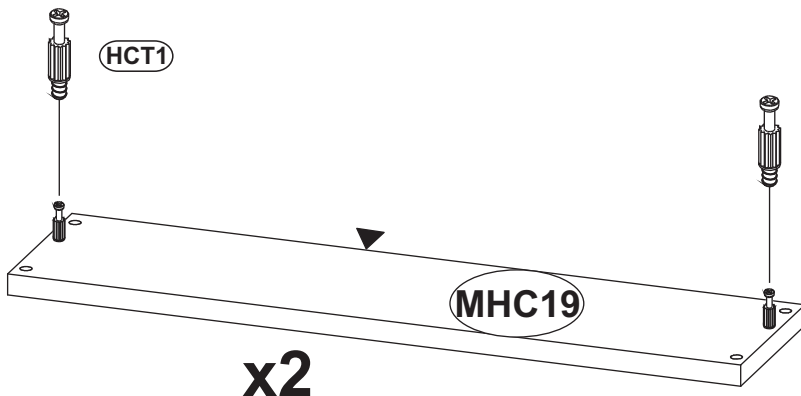
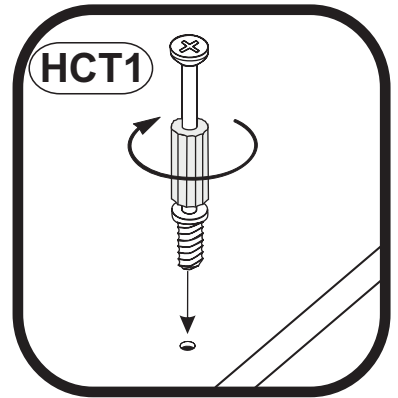

x2

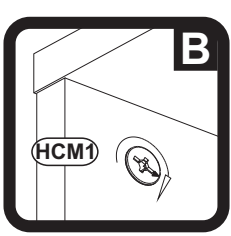
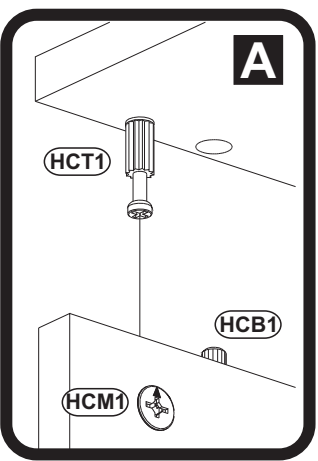
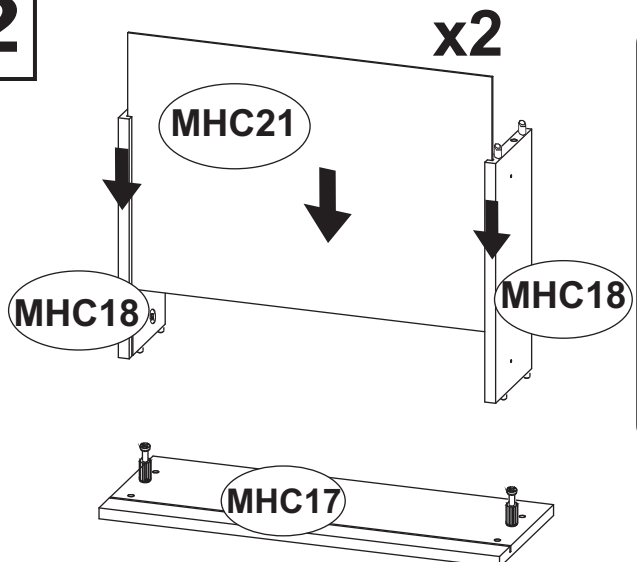

2

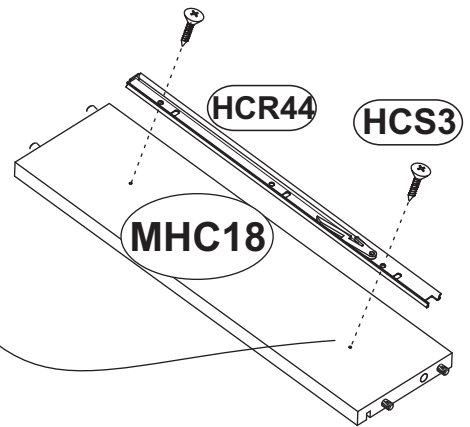
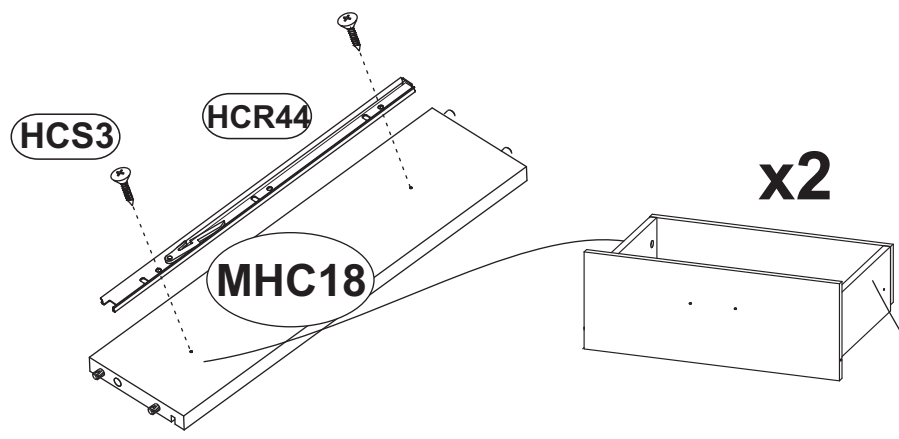
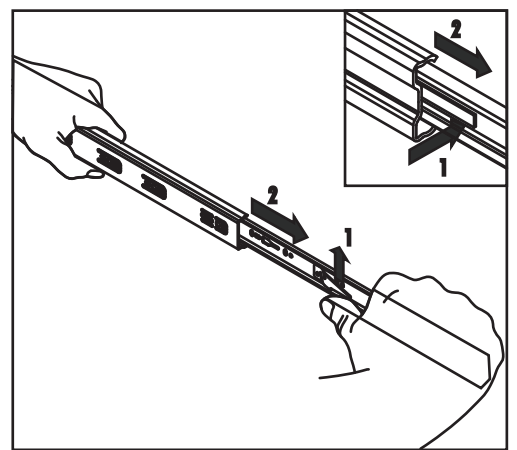
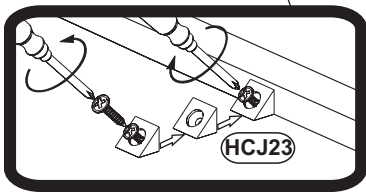
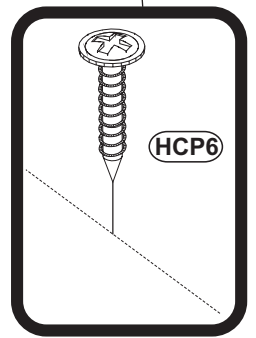
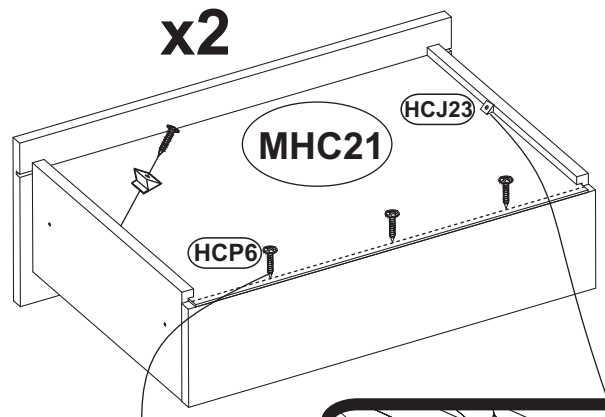
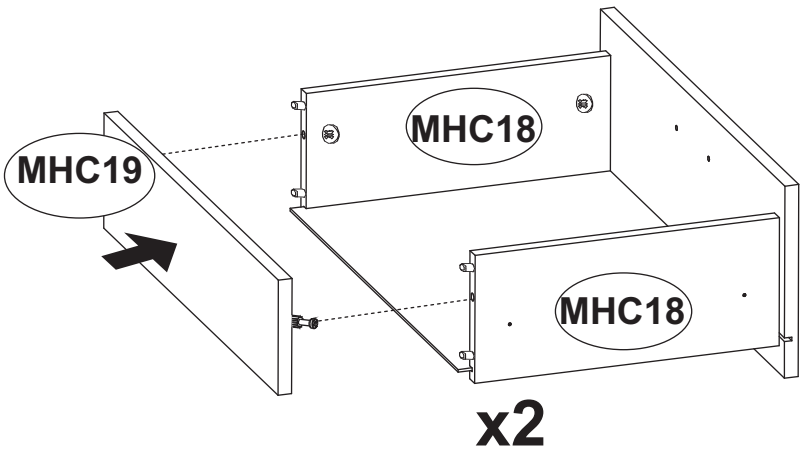

HCJ23	1302	x4
HCP6	1056	x6
HCS3	1011	x8
HCR44	123165	x4

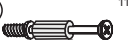

3

HCB1		1018
	8x28	x8
HCM1		123894
		x8
HCT1		11809
		x4

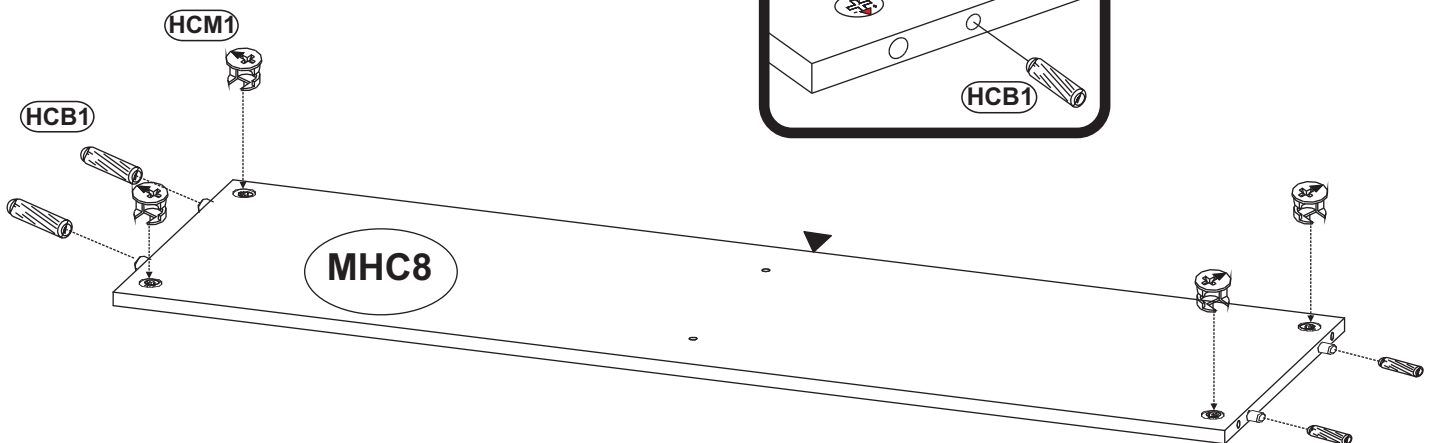
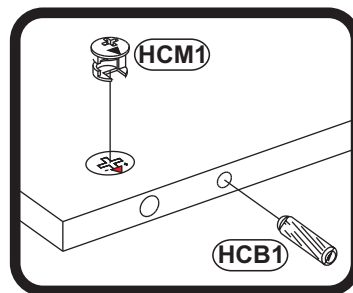
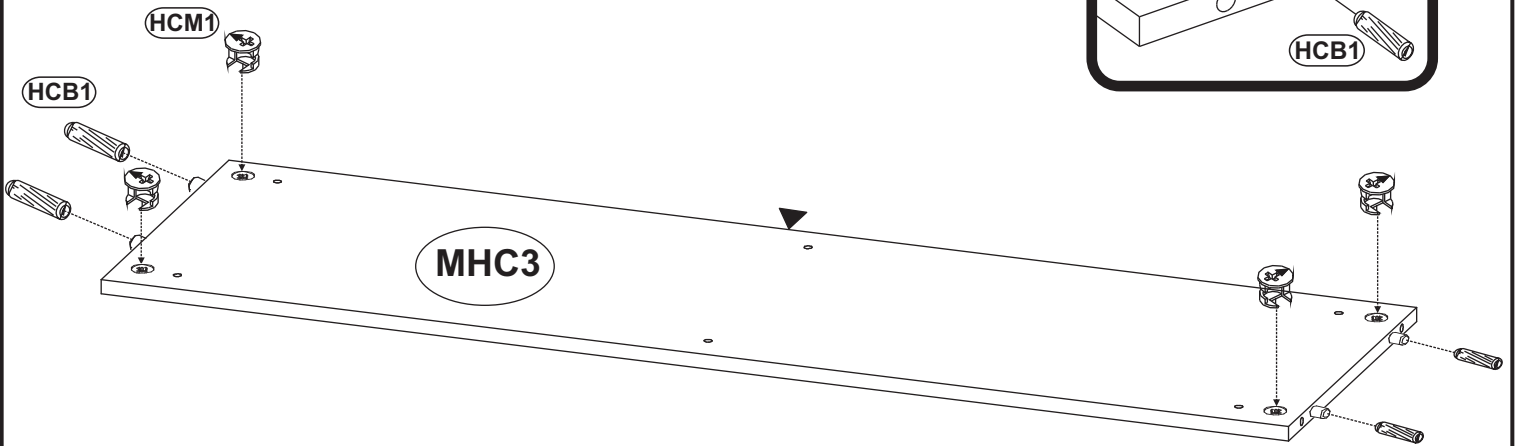
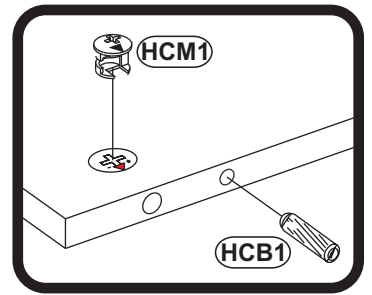
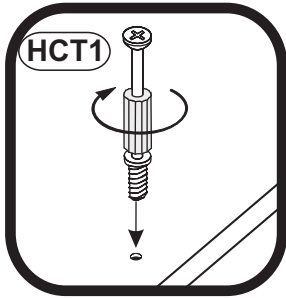
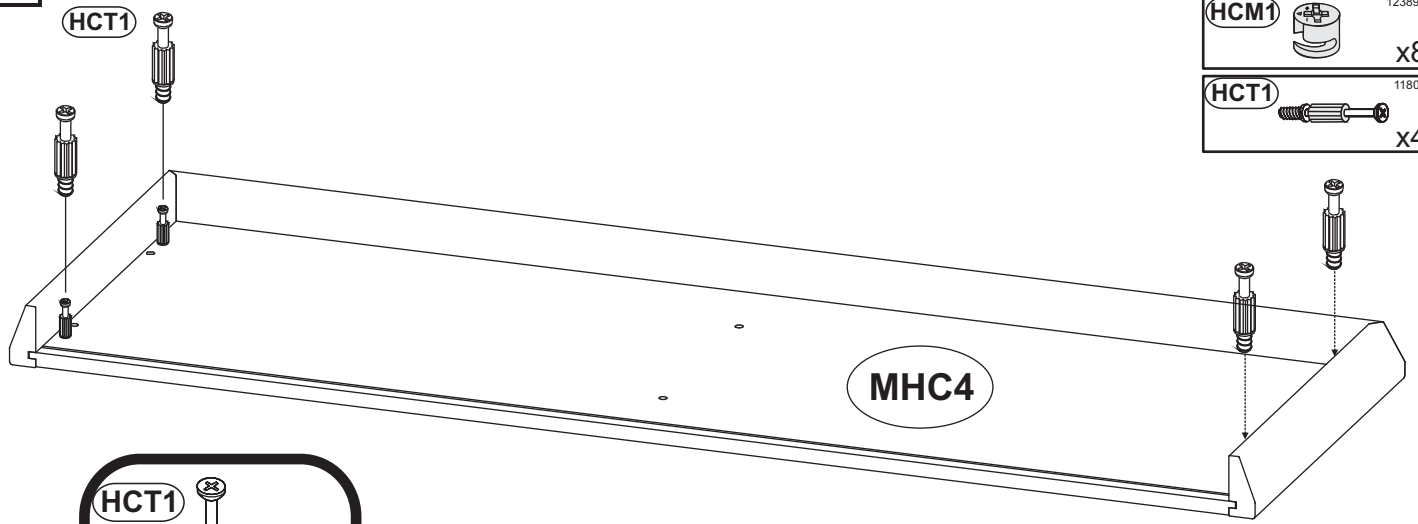

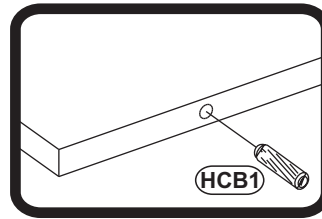
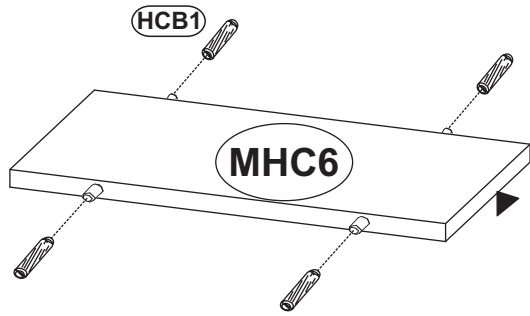

- HCB1 1018
 8x28 x10
- HCR44 123165
 L-350 x4
- HCS3 1011
 3,5x13 x16

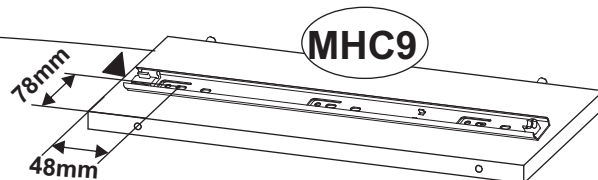
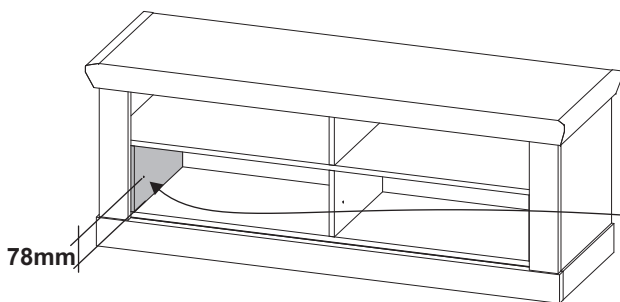
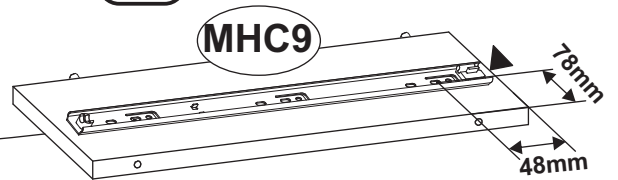
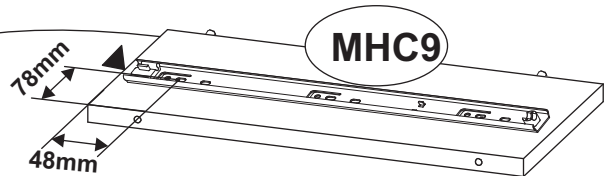
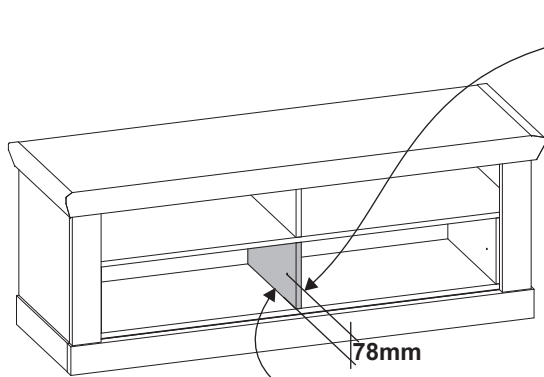
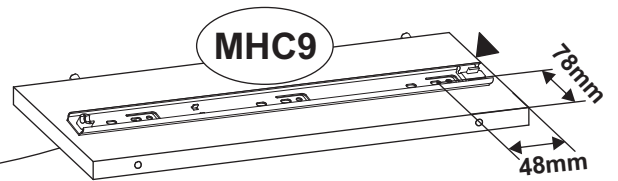
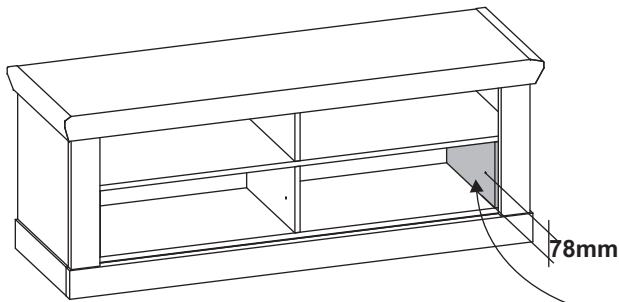
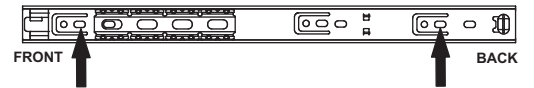
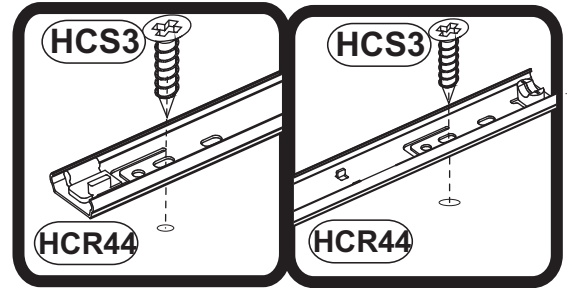
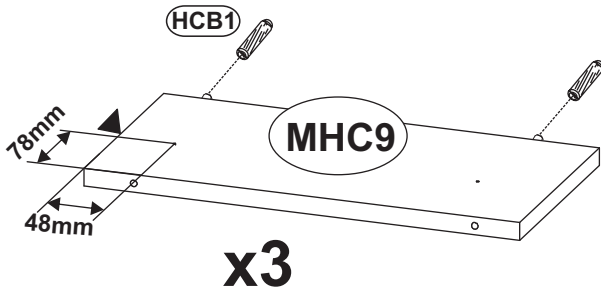

5

HCB1		1018
	8x28	x4
HCM1		123894
		x4
HCT1		11809
		x8
HCK13		49716
		x4
HCS3		1011
	3,5x13	x8

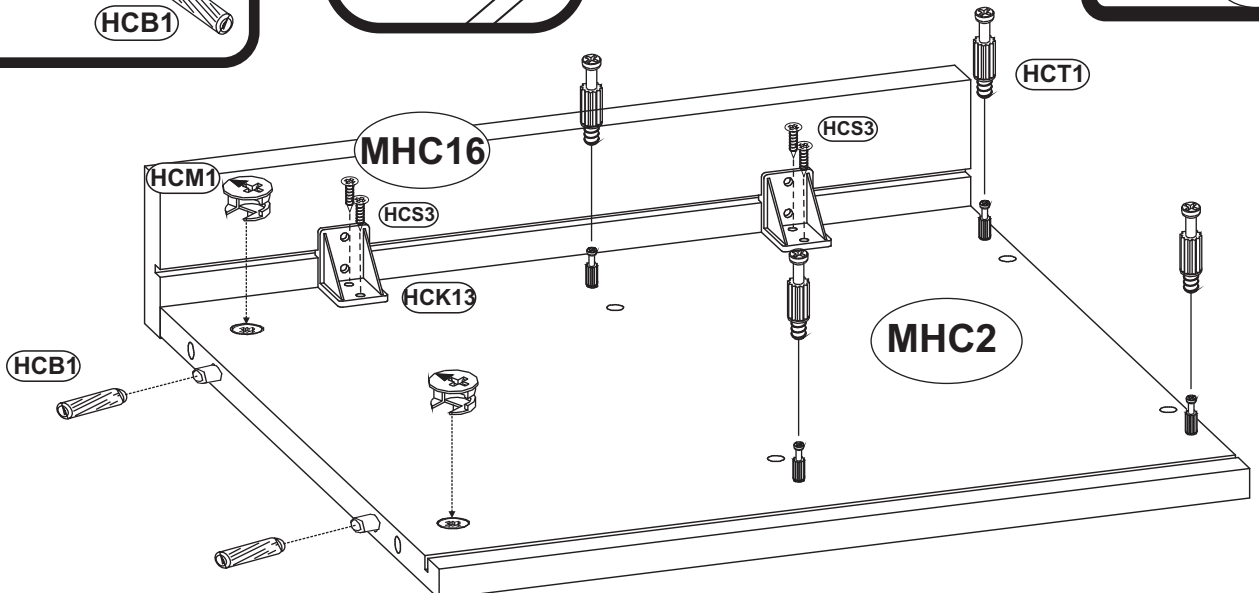
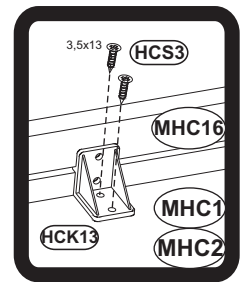
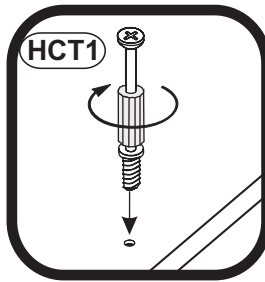
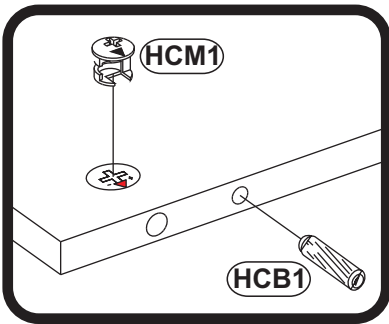
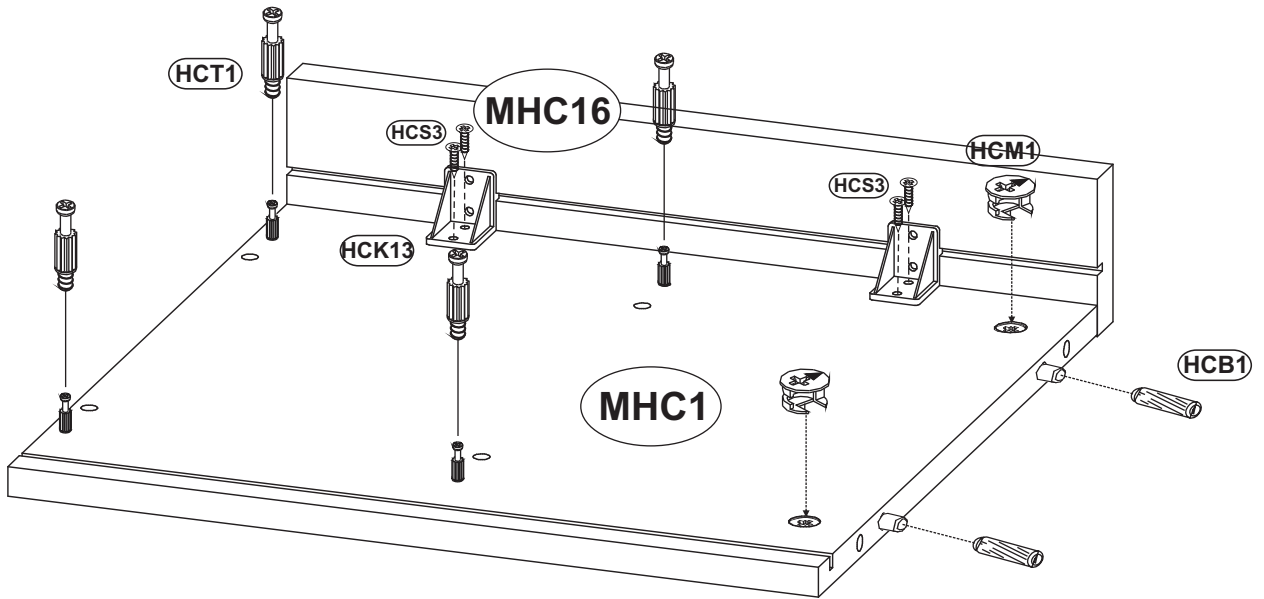
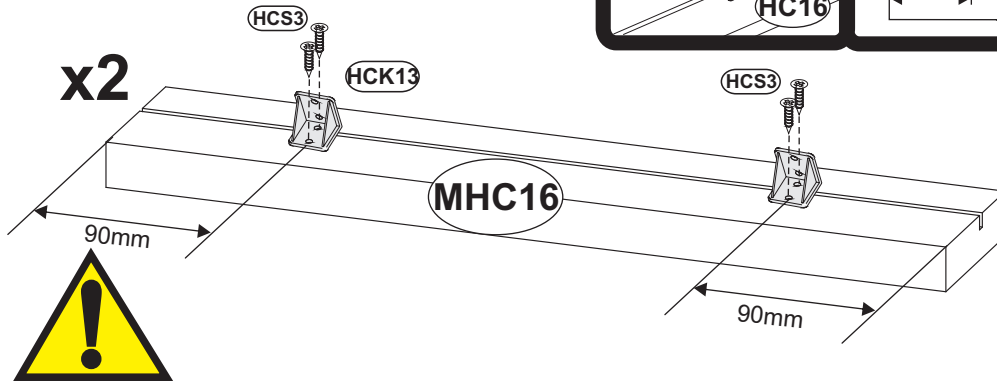
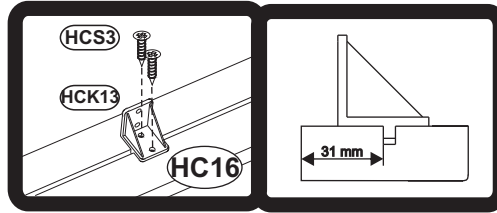

6

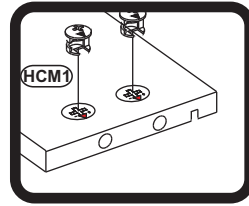
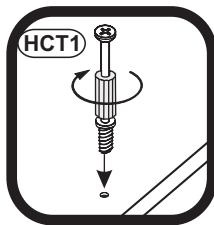
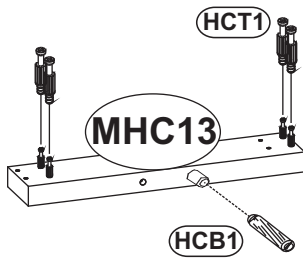
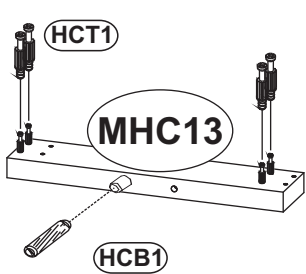

HCM1		123894	x8
HCT1		11809	x8
HCS3		1011	3,5x13 x12
HCK13		49716	x6
HCB1		1018	8x28 x2



x2

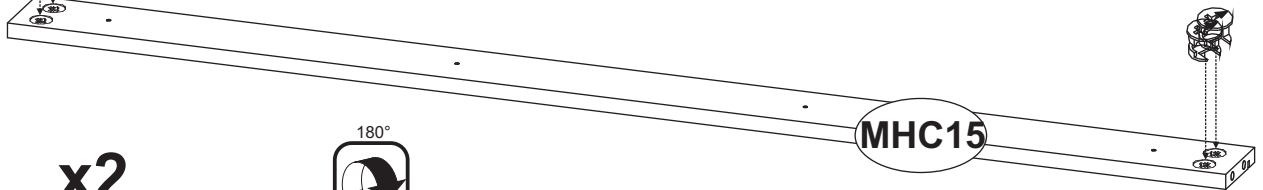

x2

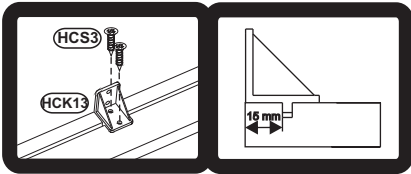
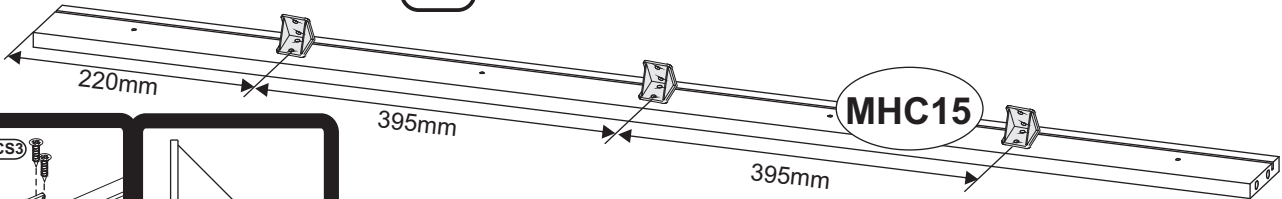

7

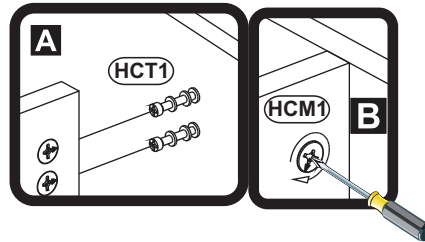

HCP13		1012	4x30 x4
HCF36		1305	x8

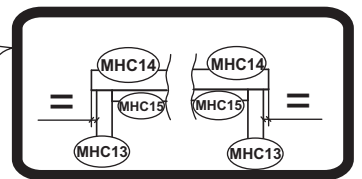
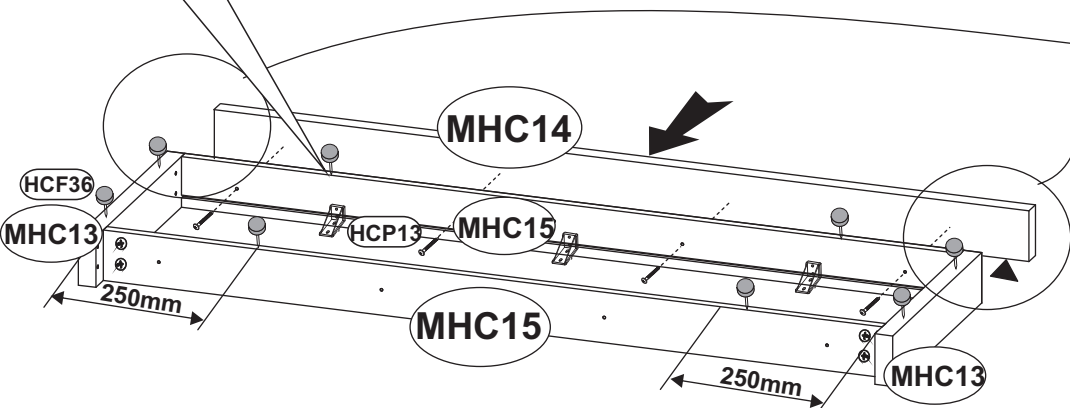
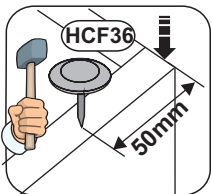
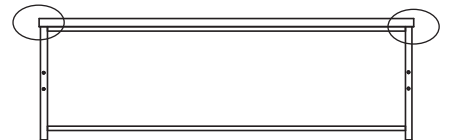
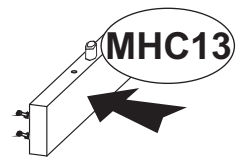
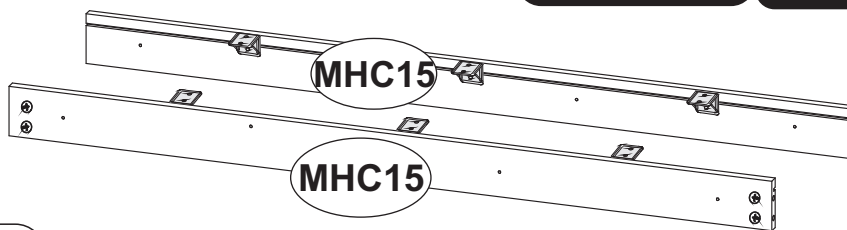

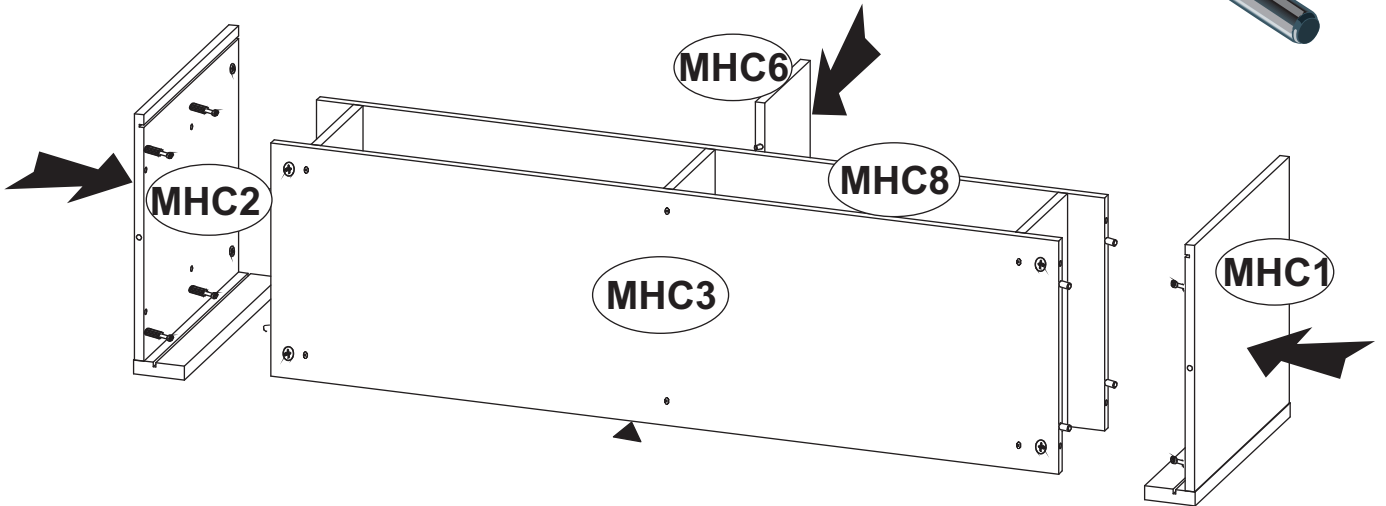
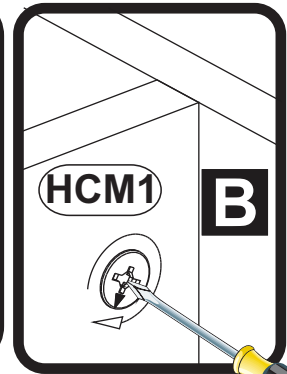
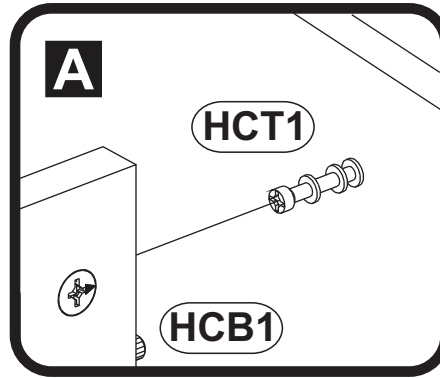
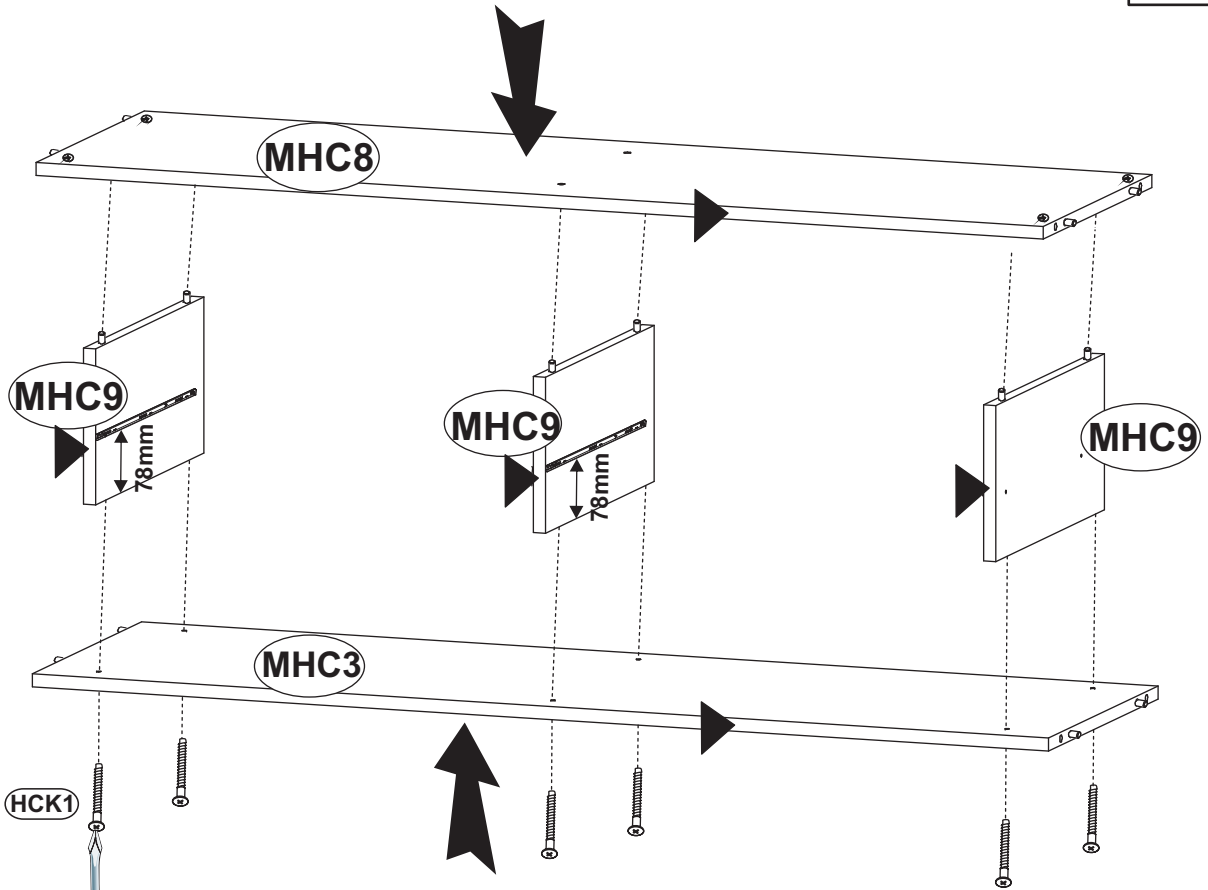

9

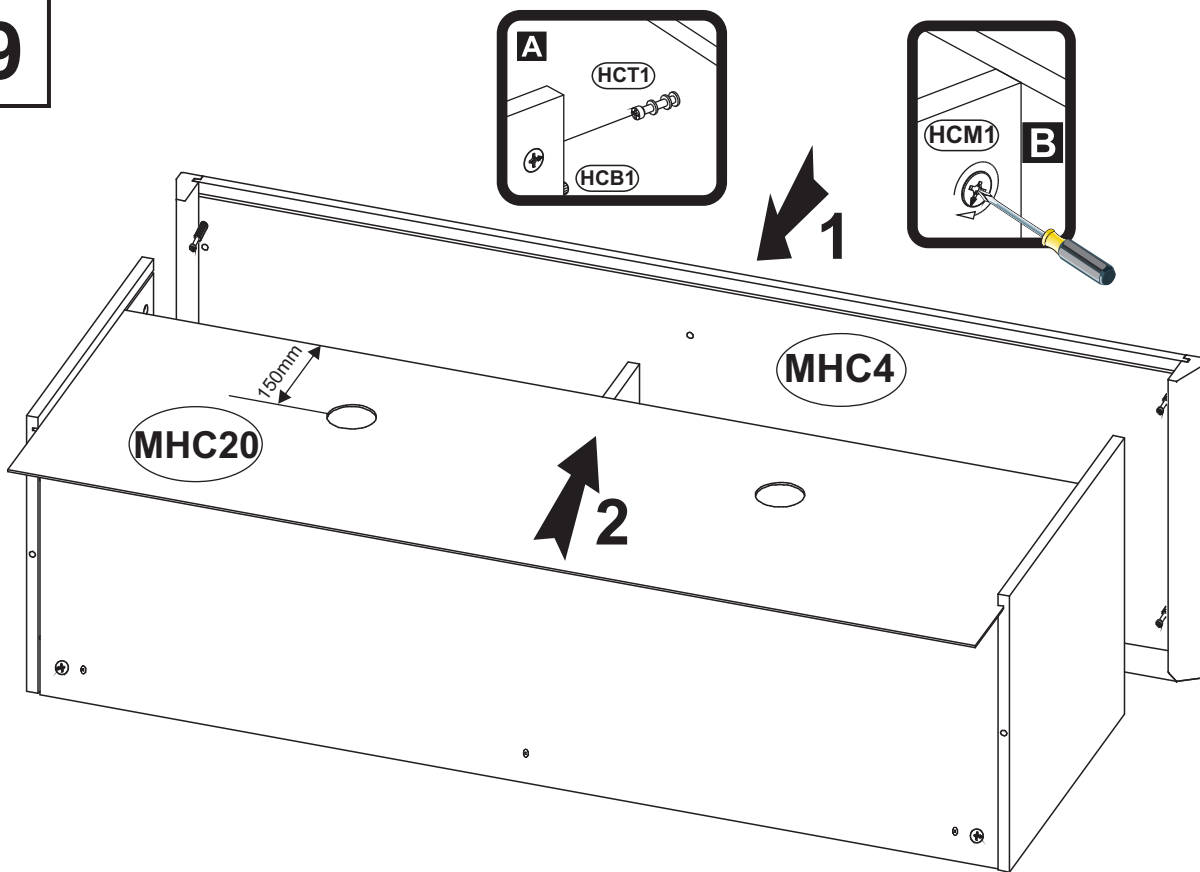

10

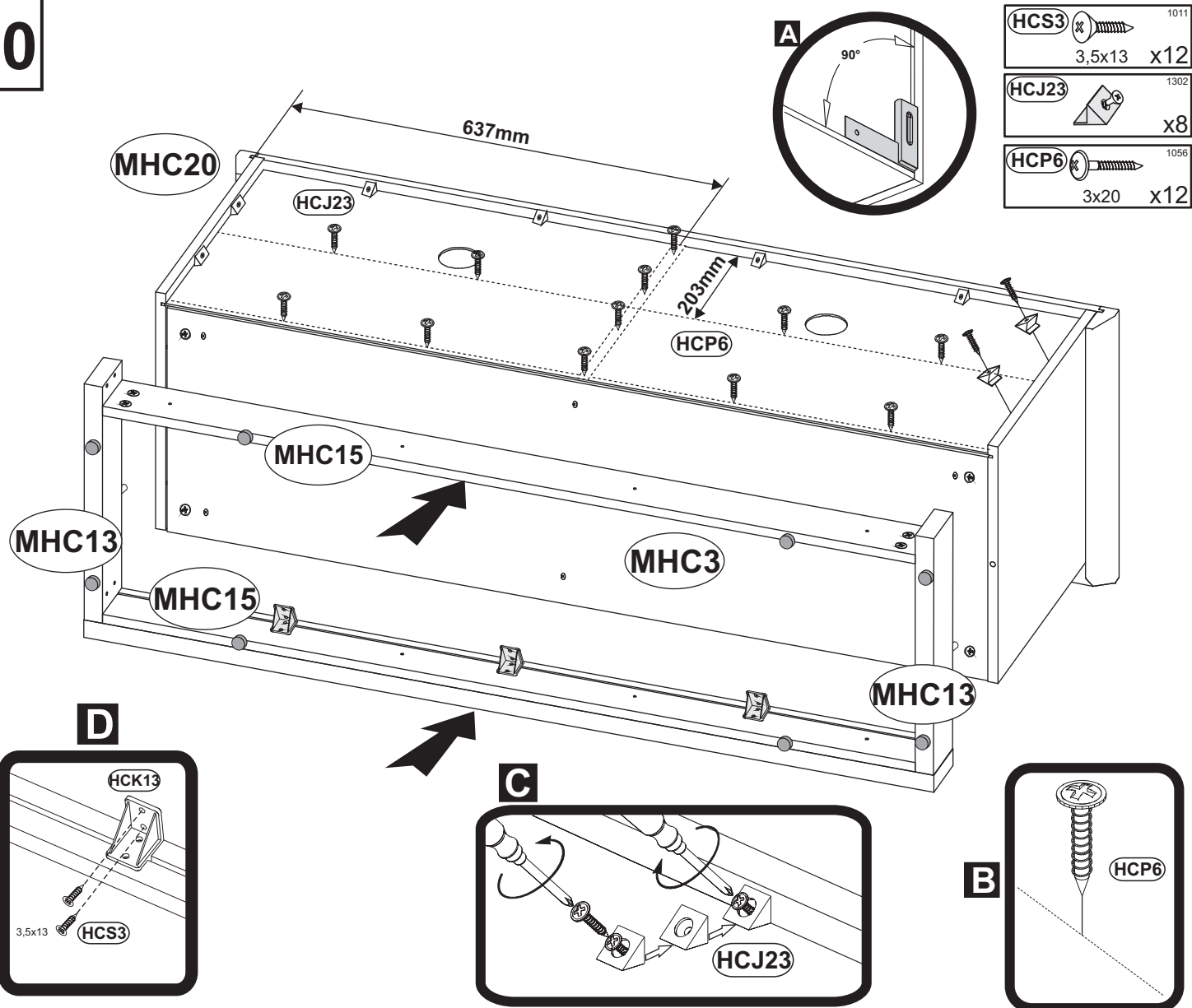

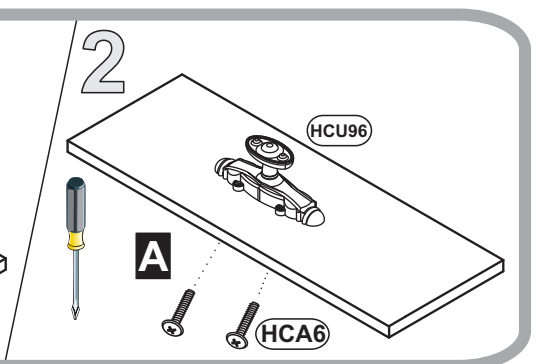
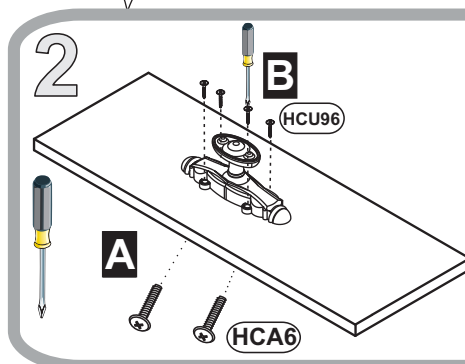
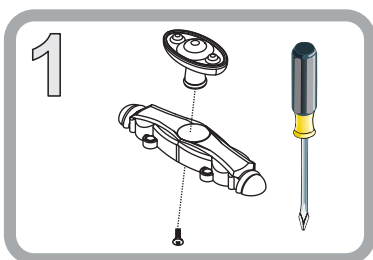
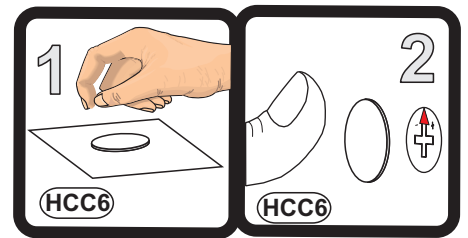
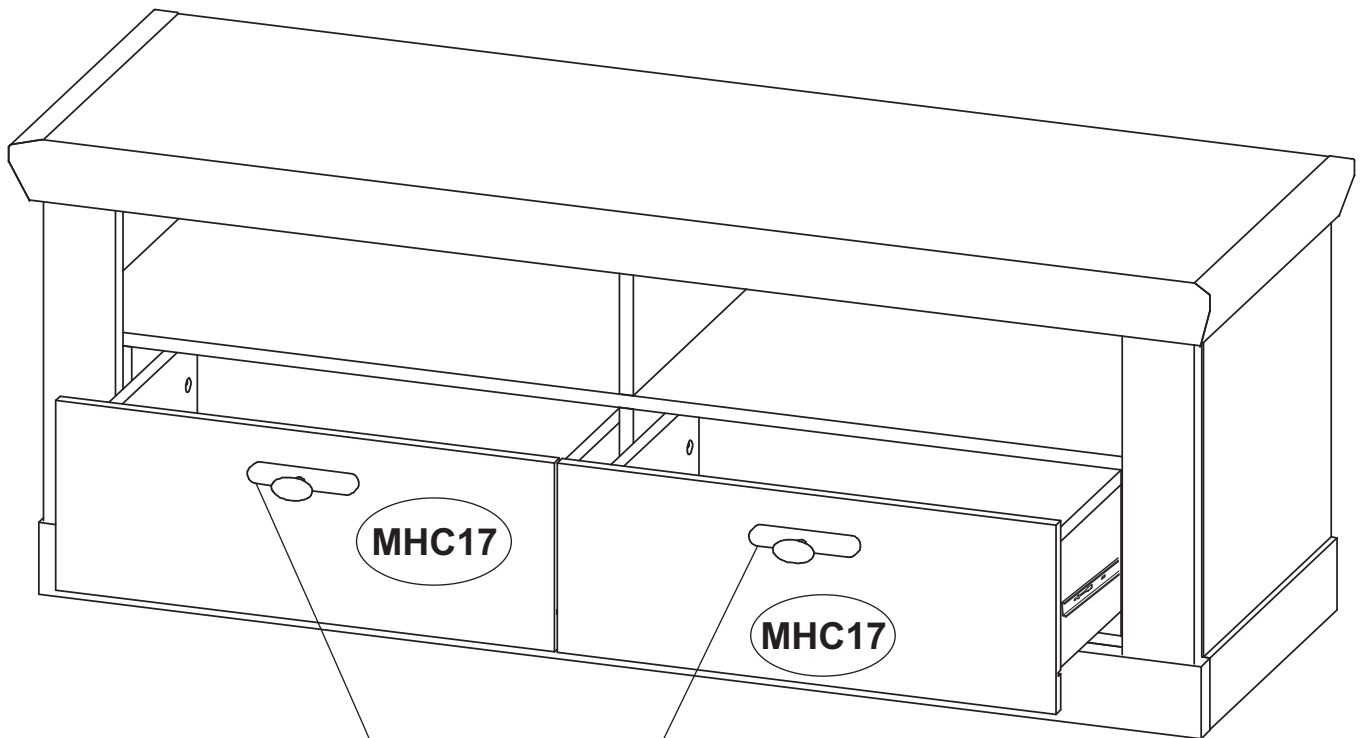
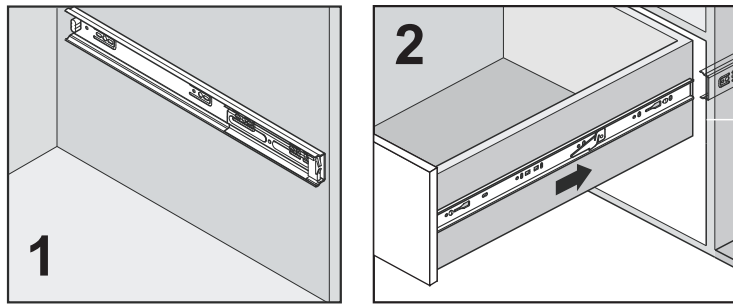
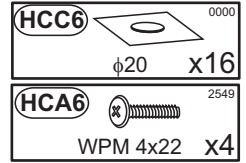
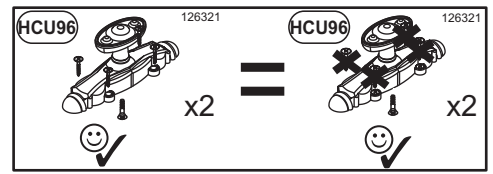

FLORENZ 31M

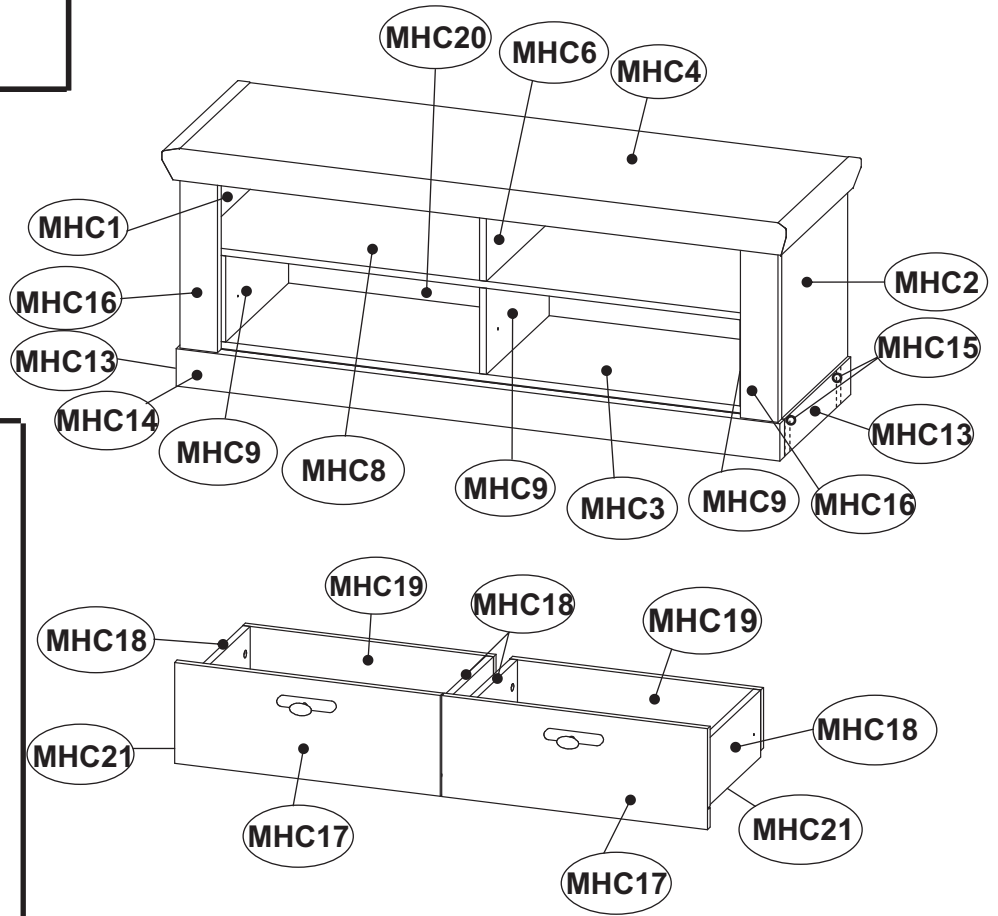

Unser Direktservice für Beschlagteile

Sollte Ihnen ein Beschlagteil fehlen, können Sie diese Servicekarte direkt an die untenstehende Adresse mailen. Wir können allerdings nur Beschlagteile auf diesem Wege verschicken. Sollten Sie eine andere Beanstandung an Ihrem Möbelstück haben, so wenden Sie sich bitte direkt an Ihr Möbelhaus.

Our direct order service for fitting

If a fitting part is missing, you can e-mail this service card directly to the address below. However, we can only send fitting parts in this way. If you have any other cause for complaint concerning your item of furniture, please contact your furniture store directly.

Náše priamé služby pro kování

Chybí-li vám nějaký díl z kování, můžete tuto servisní kartu odeslat e-mailem přímo na níže uvedenou adresu. Touto cestou však můžeme rozesílat jen díly kování. Pokud byste reklamovali jiný díl nábytku, obraťte se přímo na svého prodejce nábytku.

Bien étudier la notice de montage

S'il vous manque une ferrure, veuillez envoyer directement la présente carte service à l'adresse e-mail indiquée ci-dessous. Cependant, ceci nous permet uniquement d'envoyer des ferrures. Pour tout autre type de réclamation concernant votre meuble, veuillez contacter directement votre magasin d'ameublement.

Il nostro servizio diretto per l'ordine della ferramenta

Qualora Vi dovesse mancare un pezzo di fissaggio, allora Vi preghiamo di inviare questa carta di servizio immediatamente all'indirizzo sottostante. Possiamo inviare i pezzi di fissaggio solamente per mezzo di questo procedimento. Qualora dovesse avere qualche altra reclamazione in merito al mobile, allora Vi preghiamo di rivolgerVi direttamente al Vostro Negozio di mobili.

Нашата директна услуга за обков

Ако липсват части от комплекта, попълнете настоящата сервисна карта и ни я изпратете на e-mail адреса, посочен по-долу. По този начин можем да доставяме само липсващи елементи от обкова. Ако установите други дефекти по мебелите, Ви съветваме да се обърнете към мебелната къща/магазин, от който сте закупили стоката.

Onze directservice voor losse onderdelen

Wanneer er een onderdeel ontbreekt, kunt u deze servicekaart direct aan onderstaand e-mailadres sturen. Wij kunnen langs deze weg echter alleen beslagdelen versturen. Mocht u een ander probleem aan uw meubel hebben, verzoeken wij u contact op te nemen met uw meubeldealer.

Nasz bezpośredni serwis części montażowych

Jeżeli brakuje części koniecznych do montażu, prosimy o przesłanie nam niniejszej karty serwisowej na niżej podany adres e-mailowy. W ten sposób możemy przesyłać Państwu tylko brakujące części. W przypadku innych reklamacji dotyczących mebla, prosimy zgłosić się do salonu meblowego, w którym został dokonany zakup.

Servis za okove

U slučaju da nedostaje neki od dijelova molimo vas da na dolje navedenu mail adresu pošaljete ovaj servisni obrazac. Na ovaj način mogu se dostaviti samo okovi. U slučaju da imate dodatne prigovore vezane uz komad namještaja molimo vas da se obratite izravno trgovini namještaja gdje je isti kupljen.

Direktszolpálatunk vasalatok esetén

Ha hiányzik egy vasalat, ezt a kártyát közvetlenül elküldheti az alább található címre. Azonban csak vasalatoskat tudunk így küldeni. Amennyiben másfajta reklamációt áll fenn bütördarabját illetően, forduljon közvetlenül a bütörházhoz.

Náš priamy servis pre časti kovania

Ak by Vám chýbala nejaká časť kovania, môžete poslať túto servisnú kartu pošlou e-mailom na nižšie uvedenú adresu. Diely kovania vieme poslať iba týmto spôsobom. Ak by ste mali inú reklamáciu ohtľadom Vášho nábytku, obráťte sa priamo na Vašu predajňu nábytku.

Náše direktne uslužne storitve za okovje

Če vam manjka kakšno okovje, lahko to servisno kartico pošljete po e-pošti direktno na spodnji naslov. Po tej poti vam lahko pošljemo samo okovje. Če želite reklamirati kakšen drug del pohištva, se obrnite neposredno na vašo trgovino pohištva.

Serviciul nostru direct pentru feronerie

În cazul în care vă lipsește o piesă de feronerie puteți să trimiteți direct acest card de service prin e-mail la adresa de mai jos. Noi nu putem expedia piese de feronerie decât pe această cale. Dacă aveți o altă reclamație referitoare la piesa de mobilier, atunci vă rugăm să vă adresați direct la magazinul dvs. de mobilă.

Наш прямой сервис для поставок фурнитуры

Если окажется, что Вам не хватает того или иного элемента фурнитуры, Вы можете отправить сервисную карту по факсу непосредственно на нижеприведенный адрес электронной почты. Однако, таким образом мы можем переслать лишь фурнитуру. Если же у Вас возникнут иные претензии относительно приобретенной мебели, пожалуйста, обращайтесь непосредственно в организацию, осуществившую продажу.

Vår direktservice för beslagdelar

Om du saknar en beslagdel kan du skicka detta servicekort direkt till e-postadressen som anges nedan. Tank på att detta är den enda möjligheten att skicka beslagdelar till dig. Om du vill reklamera din möbel av en annan anledning måste du kontakta ditt möbelför direkt.

Nuestro servicio directo para accesorios

Si le falta algún accesorio, puede enviar esta tarjeta de servicio directamente a la siguiente dirección. No obstante, por este método solo podemos enviar accesorios. Si tiene alguna otra objeción sobre su mueble, consulte directamente con su mueblería.

Donatilar için doğrudan servisimiz

Bir donatınız eksikse bu servis kartını doğrudan aşağıda bulunan adrese doğrudan mail yazabilirsiniz. Sadece bu yolla donatıları gönderebiliriz. Mobilyanızda başka şikayetleriniz varsa lütfen doğrudan mobilya satıcınıza danışın.

MHC1	411	389	15	1/1
MHC2	411	389	15	1/1
MHC3	1244	368	15	1/1
MHC4	1332	439,5	65	1/1
MHC6	196	367	15	1/1
MHC8	1244	368	15	1/1
MHC9	185	368	15	1/1
MHC13	386	80	28	1/1
MHC14	1288	80	28	1/1
MHC15	1231	80	15	1/1

MHC16	411	80	22	1/1
MHC17	553	210	15	1/1
MHC18	332	140	15	1/1
MHC19	522	126	15	1/1
MHC20	1256	416	3	1/1
MHC21	503	354	3	1/1

FLORENZ 31M

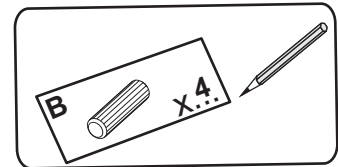
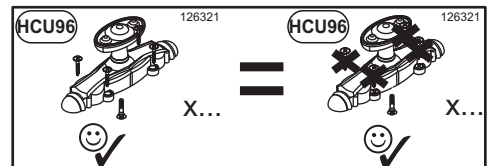
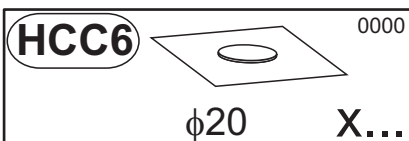
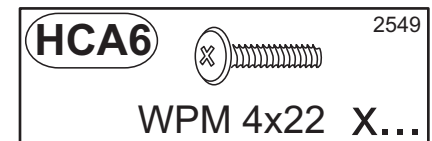
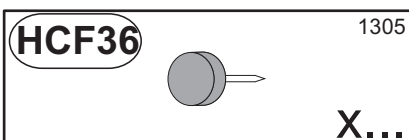
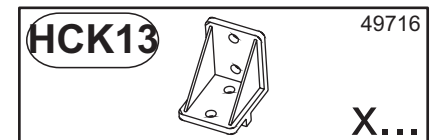
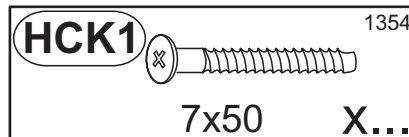
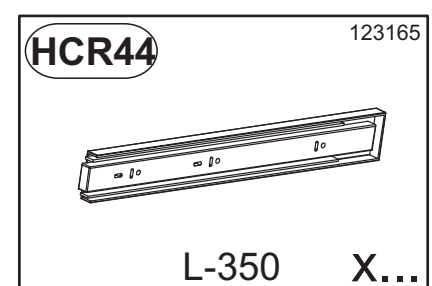
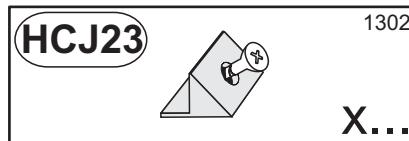
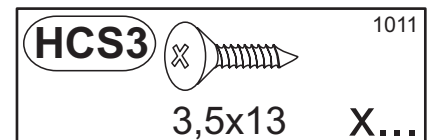
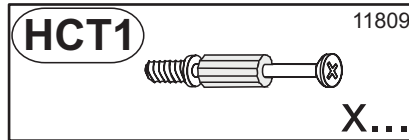
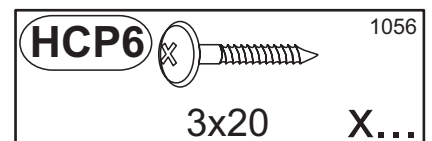
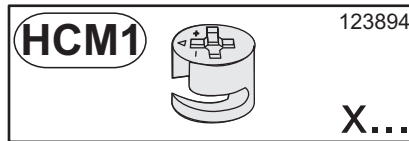
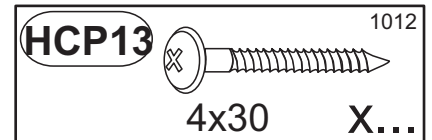
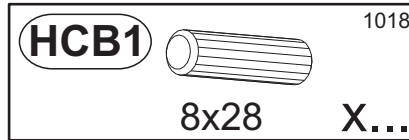

D Unser Direktservice für Beschlagteile
Sollte Ihnen ein Beschlagteil fehlen, können Sie diese Servicekarte direkt an die untenstehende Adresse mailen. Wir können allerdings nur Beschlagteile auf diesem Wege verschicken. Sollen Sie eine andere Beanstandung an Ihrem Möbelstück haben, so wenden sie sich bitte direkt an Ihr Möbelhaus.

GB Our direct order service for fitting
If a fitting part is missing, you can e-mail this service card directly to the address below. However, we can only send fitting parts in this way. If you have any other cause for complaint concerning your item of furniture, please contact your furniture store directly.

CZ Naše přímé služby pro kování
Chybí-li vám nějaký díl z kování, můžete tuto servisní kartu odeslat e-mailem přímo na níže uvedenou adresu. Touto cestou však můžeme rozesílat jen díly kování. Pokud byste reklamovali jiný díl nábytku, obraťte se přímo na svého prodejce nábytku.

F Bien étudier la notice de montage
S'il vous manque une ferrure, veuillez envoyer directement la présente carte service à l'adresse e-mail indiquée ci-dessous. Cependant, ceci nous permet uniquement d'envoyer des ferrures. Pour tout autre type de réclamation concernant votre meuble, veuillez contacter directement votre magasin d'ameublement.

I Il nostro servizio diretto per l'ordine della ferramenta
Qualora Vi dovesse mancare un pezzo di fissaggio, allora Vi preghiamo di inviare questa carta di servizio immediatamente all'indirizzo sottostante. Possiamo inviare i pezzi di fissaggio solamente per mezzo di questo procedimento. Qualora dovesse avere qualche altra reclamazione in merito al mobile, allora Vi preghiamo di rivolgerVi direttamente al Vostro Negozio di mobili.

BG Нашата директна услуга за обкоя
Ако липсват части от комплекта, попълнете настоящата сервисна карта и ни я изпратете на e-mail адреса, посочен по-долу. По този начин можем да доставяме само липсващи елементи от обкоя. Ако установите други дефекти по мебелите, Ви съветваме да се обрънете към мебелната къща/магазин, от който сте закупили стоката.

NL Onze directservice voor losse onderdelen
Wanneer er een onderdeel ontbreekt, kunt u deze servicekaart direct aan onderstaand e-mailadres sturen. Wij kunnen langzame weg echter alleen beslagdelen versturen. Mocht u een ander probleem aan uw meubel hebben, verzoeken wij u contact op te nemen met uw meubeldealer.

PL Nasz bezpośredni serwis czeski montażowych
Jeżeli brakuje części koniecznych do montażu, prosimy o przesłanie nam niniejszej karty serwisowej na niżej podany adres e-mailowy. W ten sposób możemy przesyłać Państwu tylko brakujące części. W przypadku innych reklamacji dotyczących mebla, prosimy zgłosić się do salonu meblowego, w którym został dokonany zakup.

HR Servis za okove
U slučaju da nedostaje neki od dijelova molimo vas da na dolje navedenu mail adresu pošaljete ovaj servisni obrazac. Na ovaj način mogu se dostaviti samo okovi. U slučaju da imate dodatne prigovore vezane uz komad namještaja molimo vas da se obratite izravno trgovini namještaja gdje je isti kupljen.

HU Direktszolgalatunk vasalatok esetén
Ha hiányzik egy vasalát, ezt a kártyát közvetlenül elküldheti az alább található címre. Azonban csak vasalátokat tudunk így küldeni. Amennyiben másfajta reklamáció áll fenn bútordarabát illetően, forduljon közvetlenül a bútorházhoz.

SK Naš priamy servis pre časti kovania
Ak by Vám chýbala nejaká časť kovania, môžete poslať túto servisnú kartu poslať e-mailom na nižšie uvedenú adresu. Díly kovania vieme poslať iba týmto spôsobom. Ak by ste mali inú reklamáciu ohľadom Vášho nábytku, obráťte sa priamo na Vašu predajňu nábytku.

SLO Naše direktne uslužne storitve za okovje
Ce vam manjka kakšno okovje, lahko to servisno kartico pošljete po e-pošti direktno na spodnji naslov. Po tej poti vam lahko pošljemo samo okovje. Ce želite reklamirati kakšen drug del pohištva, se obrnite neposredno na vašo trgovino pohištva.

RO Service-ul nostru direct pentru feronerie
In cazul in care va lipseste o piesa de feronerie puteti sa trimiteți direct acest card de service prin e-mail la adresa de mai jos. Noi nu putem expedia piese de feronerie decât pe această cale. Dacă aveți o altă reclamație referitoare la piesa de mobilier, atunci vă rugăm să vă adresați direct la magazinul dvs. de mobila.

RUS Наш прямой сервис для поставок фурнитуры
Если окажется, что Вам не хватает того или иного элемента фурнитуры, Вы можете отправить сервисную карту по факсу непосредственно на нижеприведенный адрес электронной почты. Однако, таким образом мы можем пересылать лишь фурнитуру. Если же у Вас возникнут иные претензии относительно приобретенной мебели, пожалуйста, обращайтесь непосредственно в организацию, осуществившую продажу.

S Vir direktservice för beslagsdelar
Om du saknar en beslagsdel kan du skicka detta servicekort direkt till e-postadressen som anges nedan. Tänk på att detta är den enda möjligheten att skicka beslagsdelar till dig. Om du vill reklamera din möbel av en annan anledning måste du kontakta ditt möbelför direkt.

ES Nuestro servicio directo para accesorios
Si le falta algún accesorio, puede enviar esta tarjeta de servicio directamente a la siguiente dirección. No obstante, por este método solo podemos enviar accesorios. Si tiene alguna otra objeción sobre su mueble, consulte directamente con su mueblería.

TR Donatılar için doğrudan servisimiz
Bir donatınız eksikse bu servis kartını doğrudan aşığada bulunan adrese doğrudan mail yazabilirsiniz. Sadece bu yolla donatılar gönderiliriz. Mobilyanızda başka şikayetleriniz varsa lütfen doğrudan mobilya satıcınıza danışın.

FLORENZ 41M

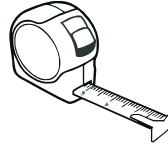

OPTION L

OPTION R

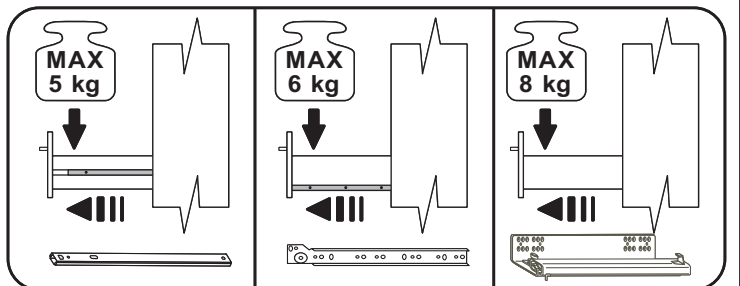
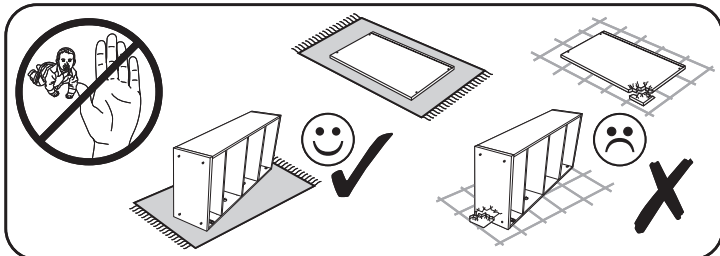
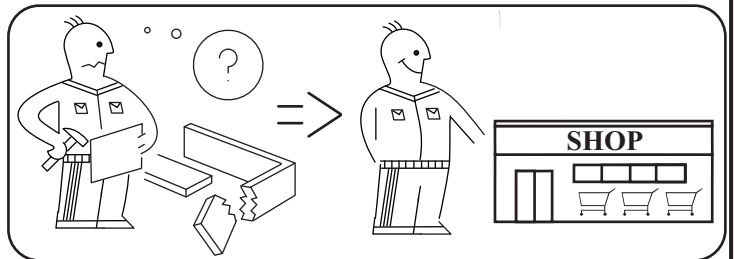
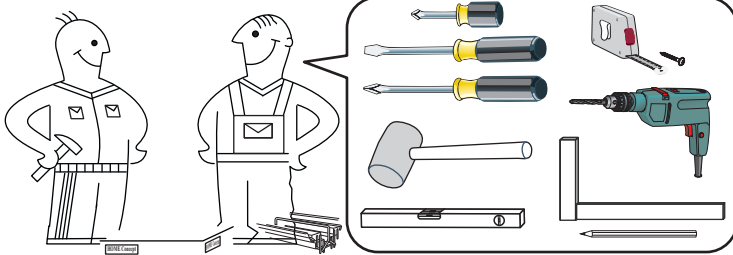
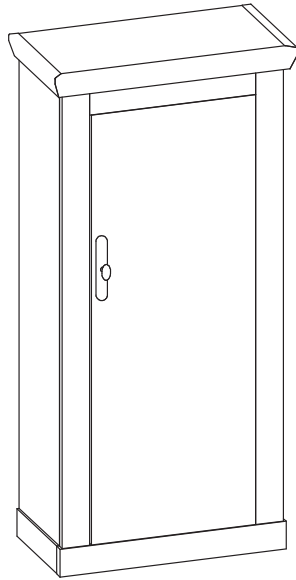
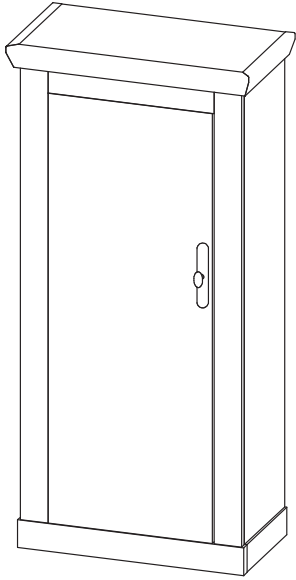

FLORENZ 41M

max.



- MHC3
- MHC4
- MHC12

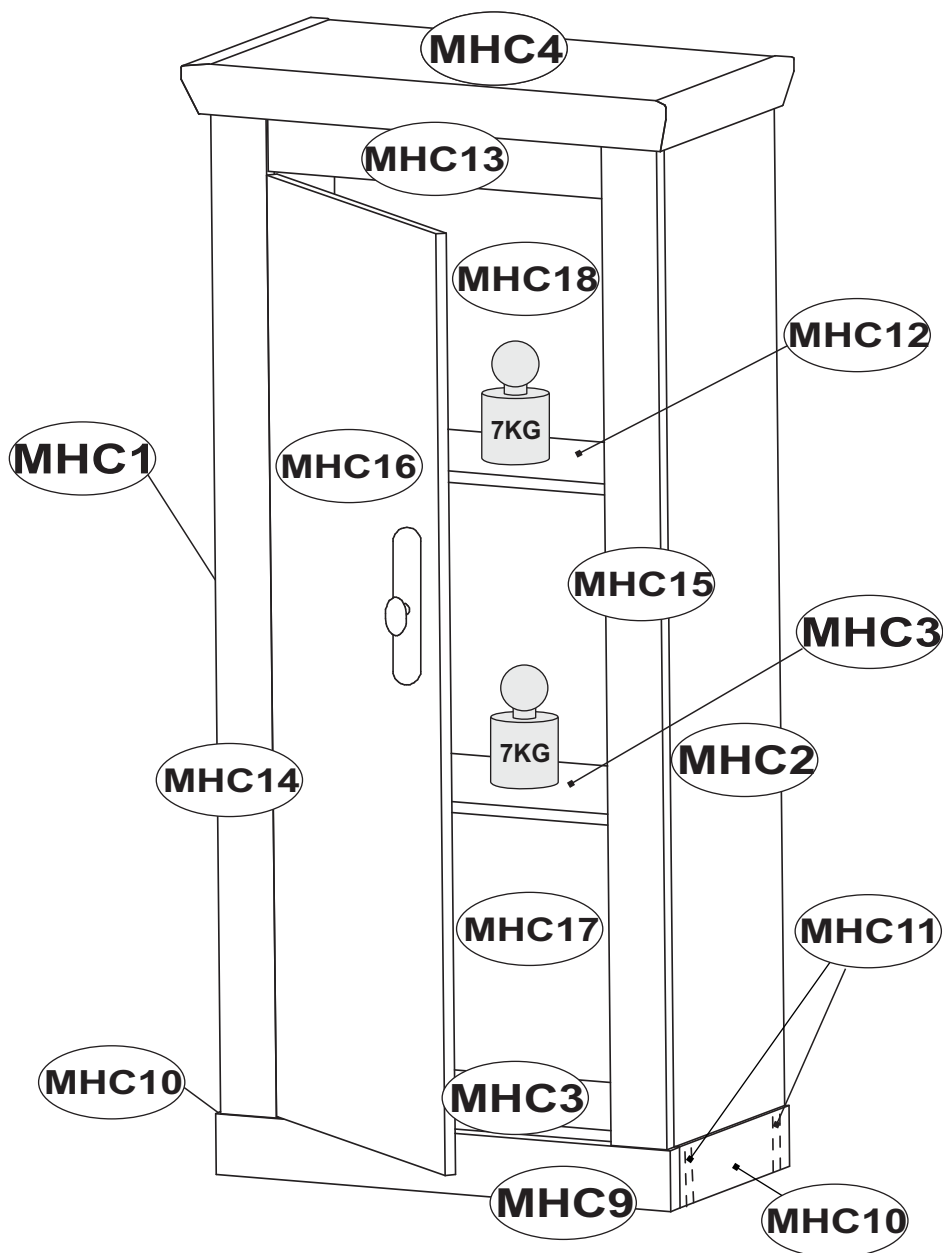

MHC1	1361	320	15	1/1
MHC2	1361	320	15	1/1
MHC3	611	299	15	1/1
MHC4	699	370,5	65	1/1
MHC9	655	80	28	1/1
MHC10	317	80	28	1/1
MHC11	598	80	15	1/1

MHC12	610	267	15	1/1
MHC13	483	120	18	1/1
MHC14	1361	80	22	1/1
MHC15	1361	80	22	1/1
MHC16	1235	477	15	1/1
MHC17	421	623	3	1/1
MHC18	945	623	3	1/1

FLORENZ 41M

HCB1  1018
8x28 x14

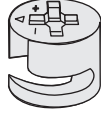
HCM1  123894
x20

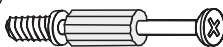
HCT1  11809
x20

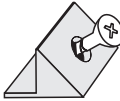
HCJ23  1302
x10

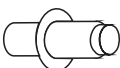
HCW1  1289
x4

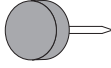
HCF36  1305
x8

HCC6  0000
φ20 x8

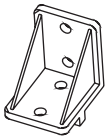
HCK13  49716
x12

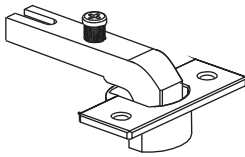
HCZ4  49365
φ35 90° x2

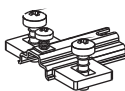
HCD14  23515
H4 x2

HCP13  1012
4x30 x3

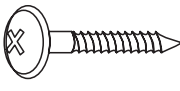
HCP6  1056
3x20 x8

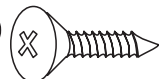
HCS3  1011
3,5x13 x60

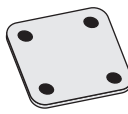
HCF14  1021
x2

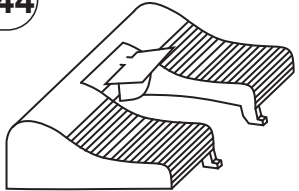
HCF44  116795
x1

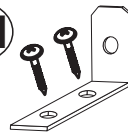
HCJ11  1267
x1

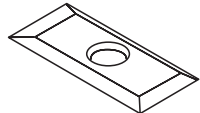
HCF1  1415
x4

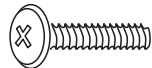

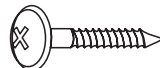
HCA6  2549
WPM 4x22 x2

HCP2  1014
3,5x13 x1

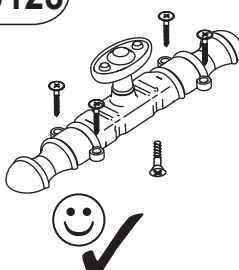
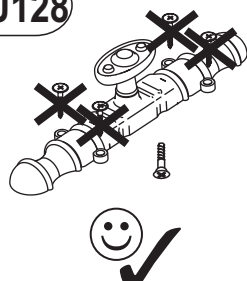
HCG54  126680
x1

HCU128  126322 x1 =  126322 x1

1

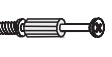
HCB1		1018
	8x28	x4
HCM1		123894
		x4
HCT1		11809
		x8

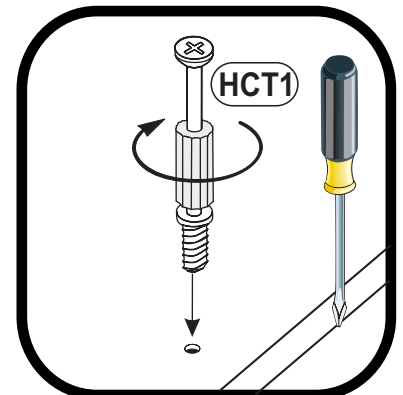
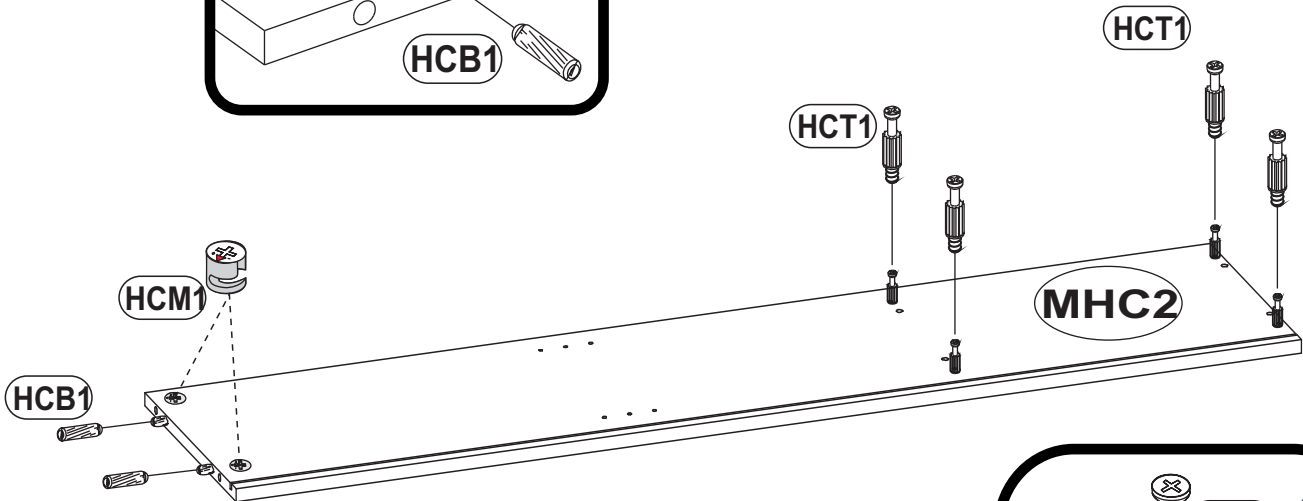
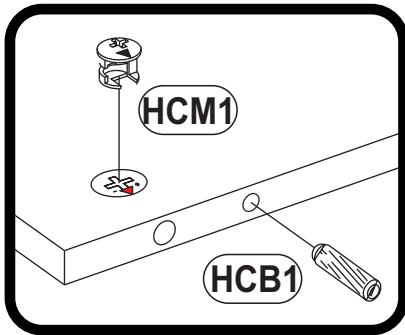
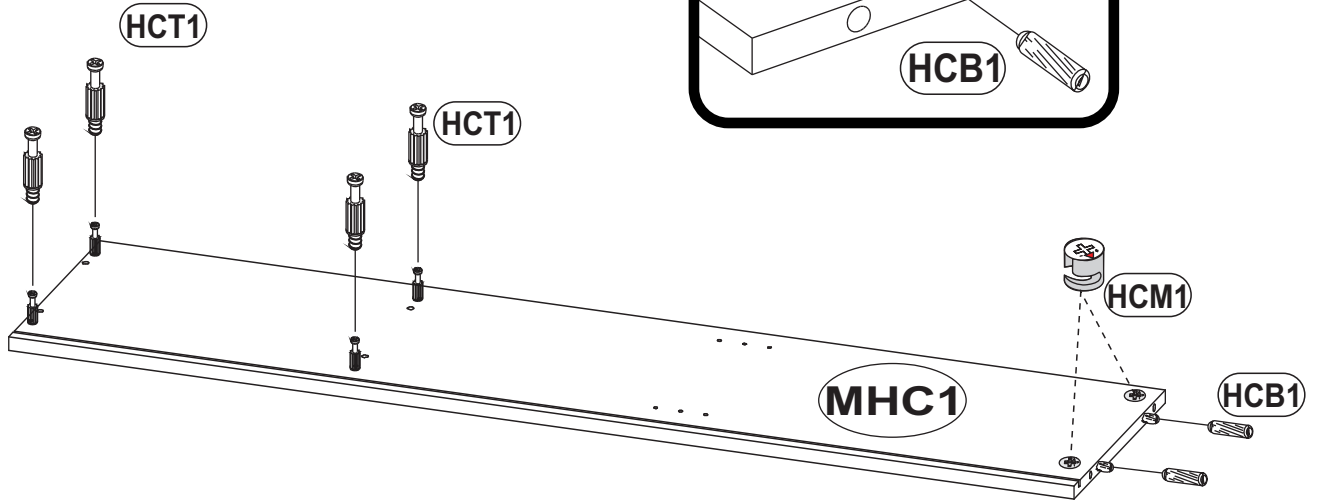
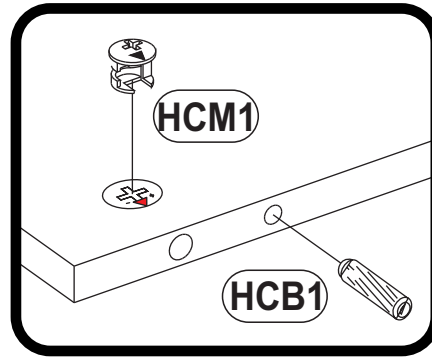
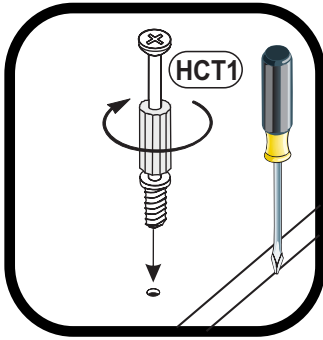

2

OPTION L

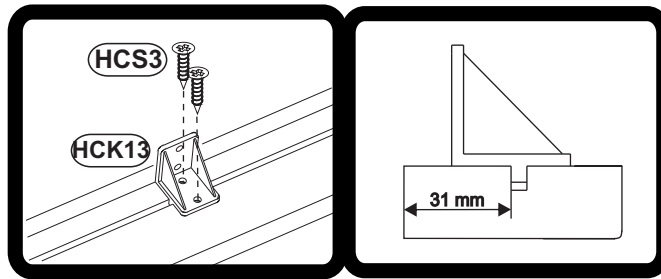
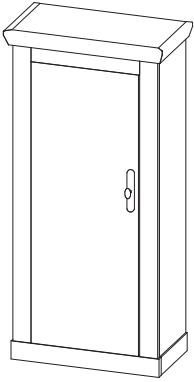

HCS3 1011
3,5x13 x16

HCD14 23515
H4 x2

HCK13 49716
x8

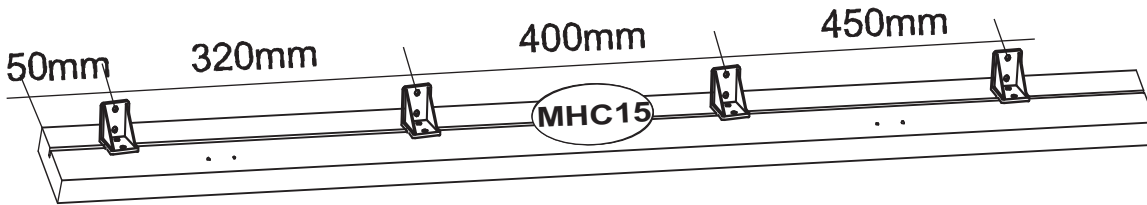
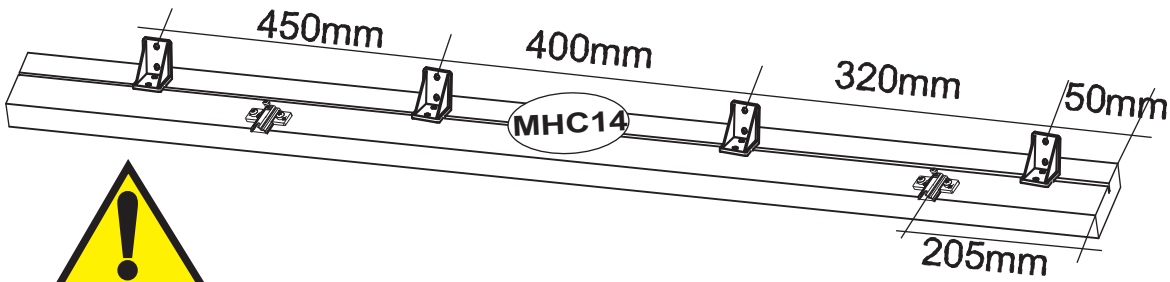
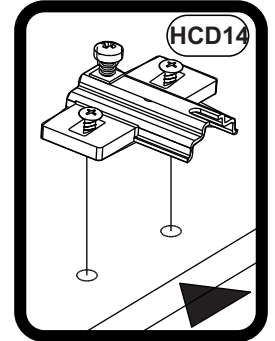

OPTION R

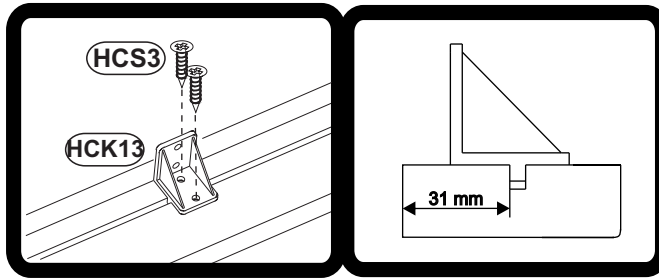
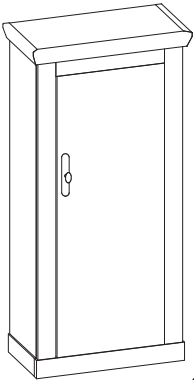



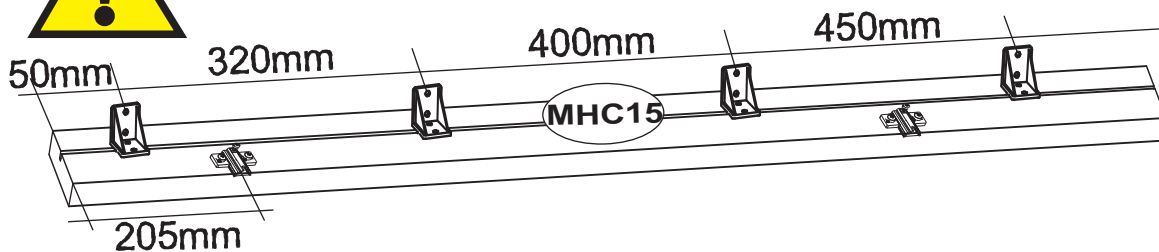
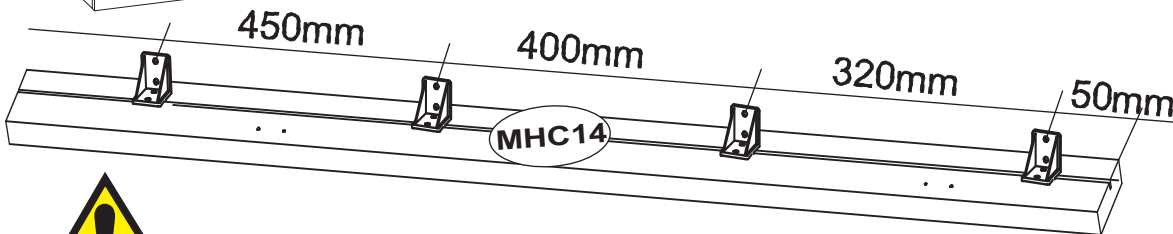
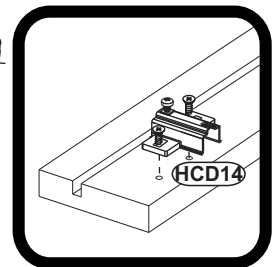

HCS3 1011
3,5x13 x16

HCD14 23515
H4 x2

HCK13 49716
x8



3



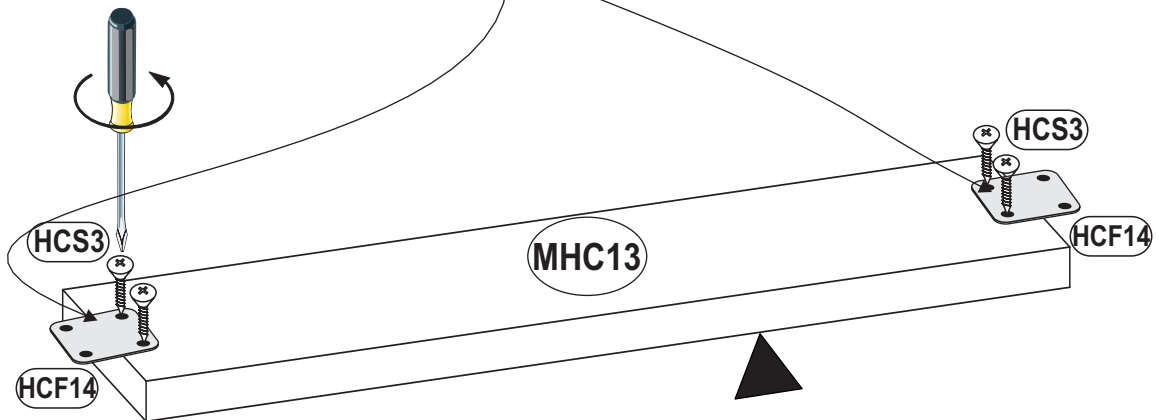
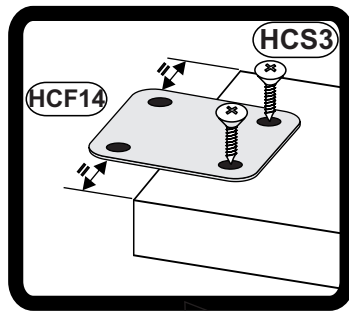
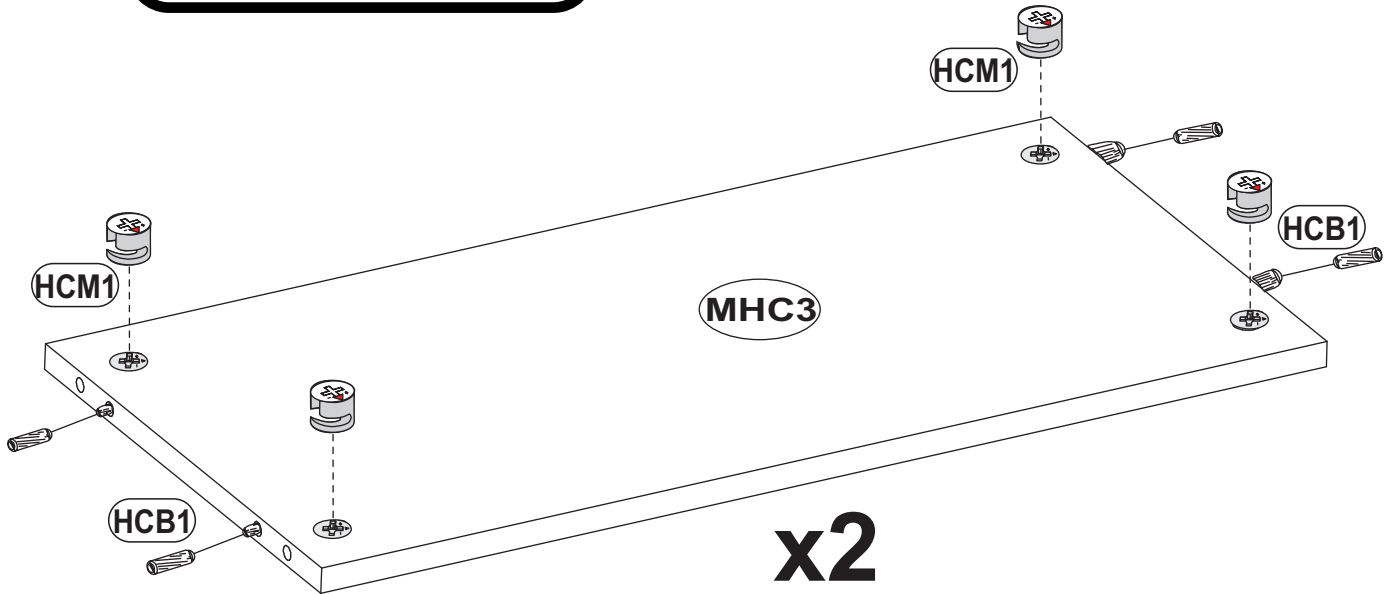
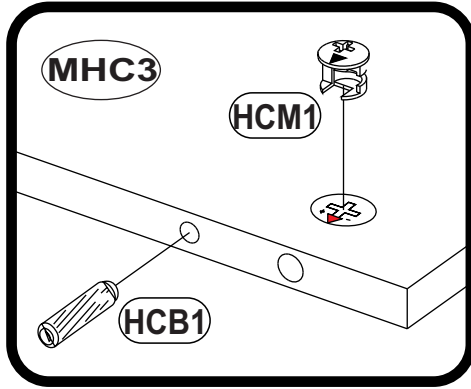

HCF14  x2	1021	HCB1  8x28 x8	1018
HCS3  3,5x13 x4	1011	HCM1  x8	123894

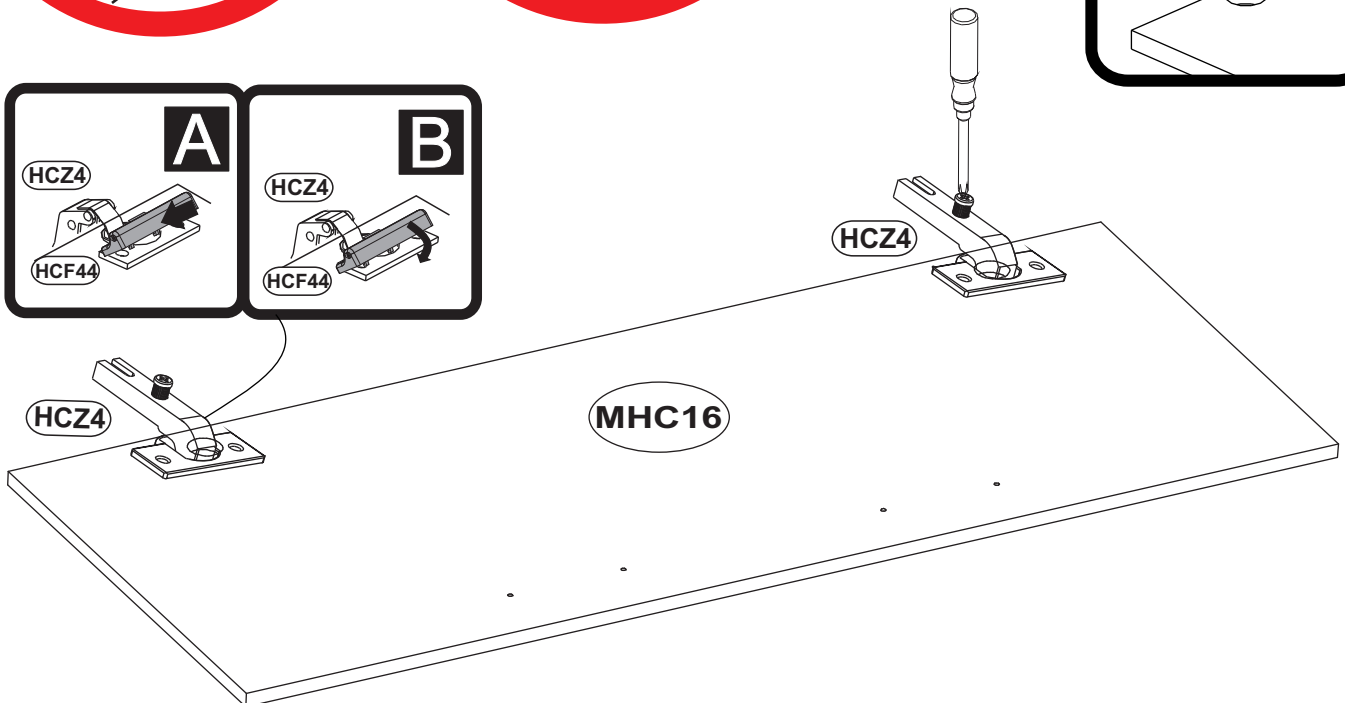
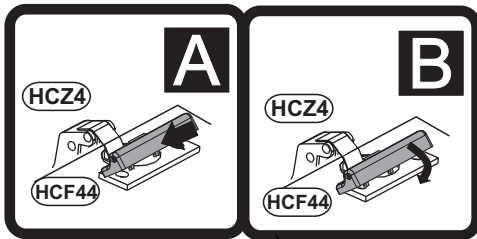
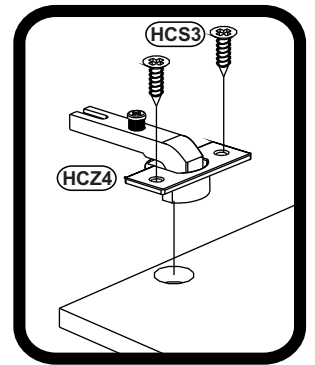
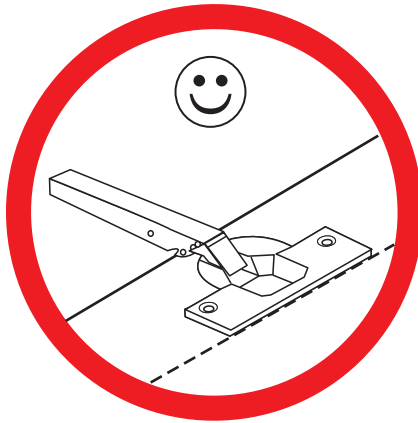
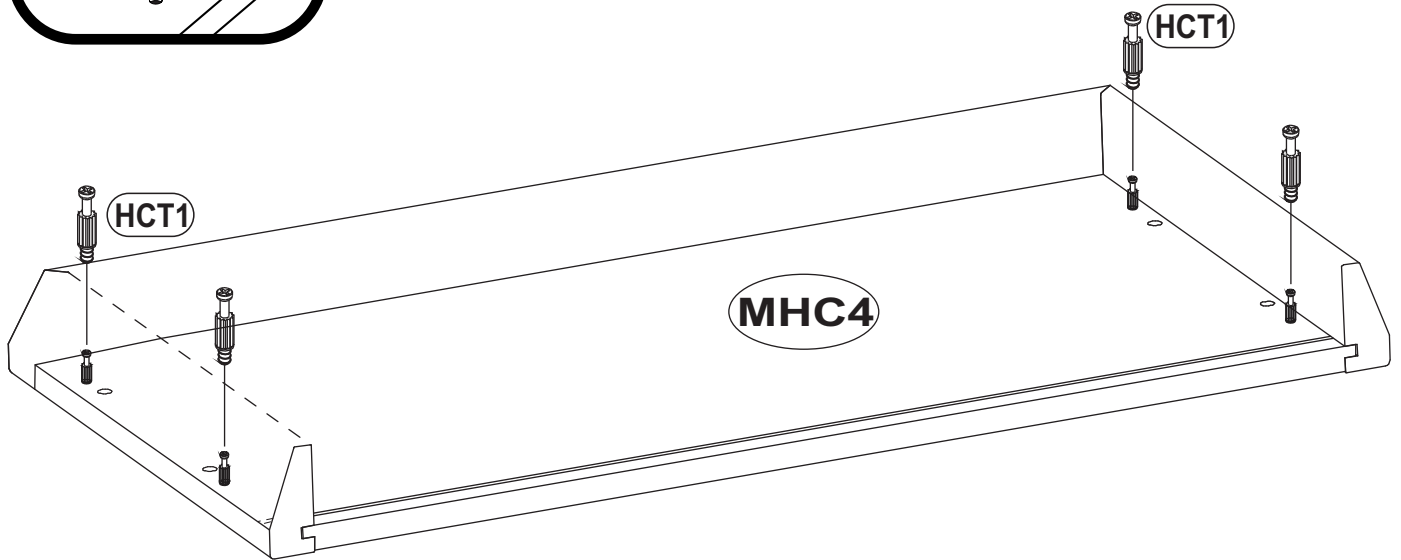
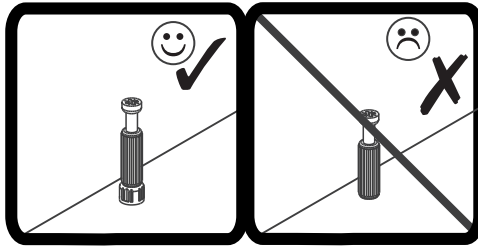
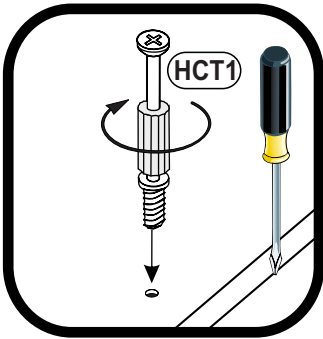
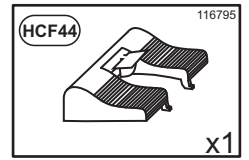
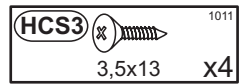
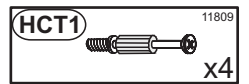
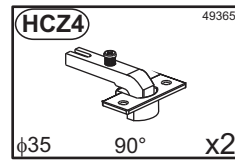

4



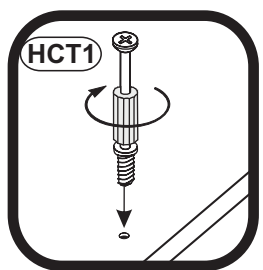
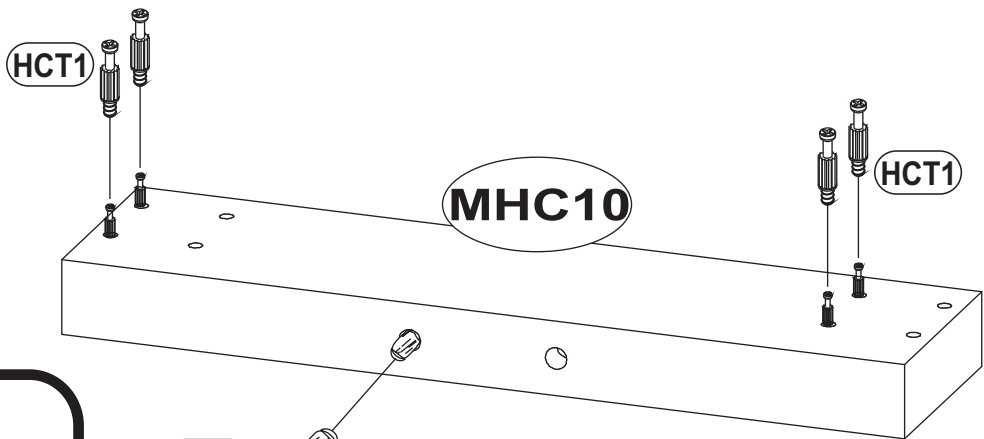
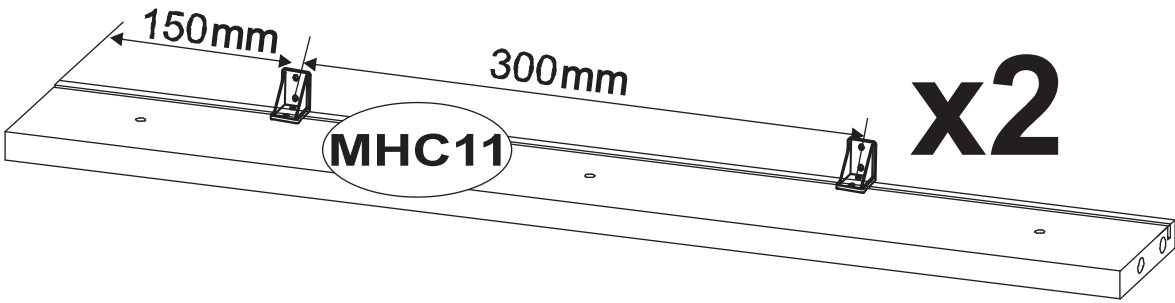
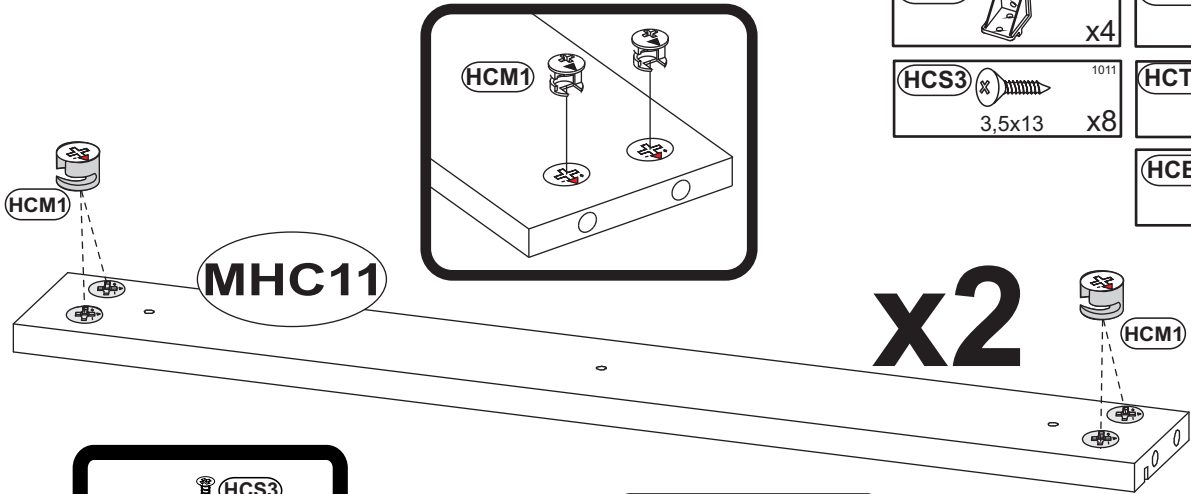

5

HCK13		49716	HCM1		123894
		x4			x8
HCS3		1011	HCT1		11809
	3,5x13	x8			x8
			HCB1		1018
				8x28	x2

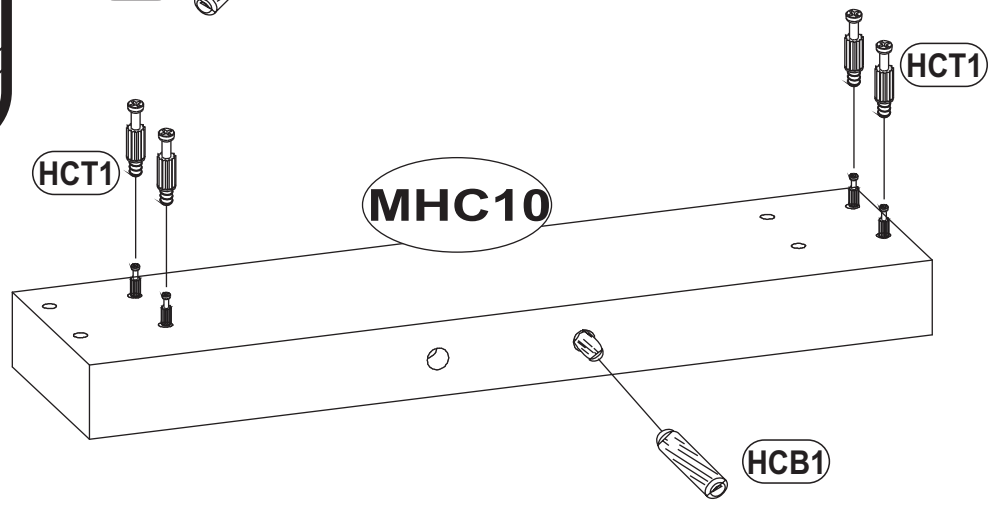

HCB1

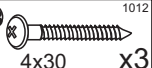



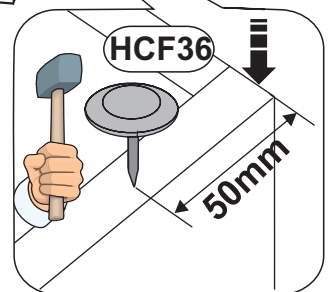
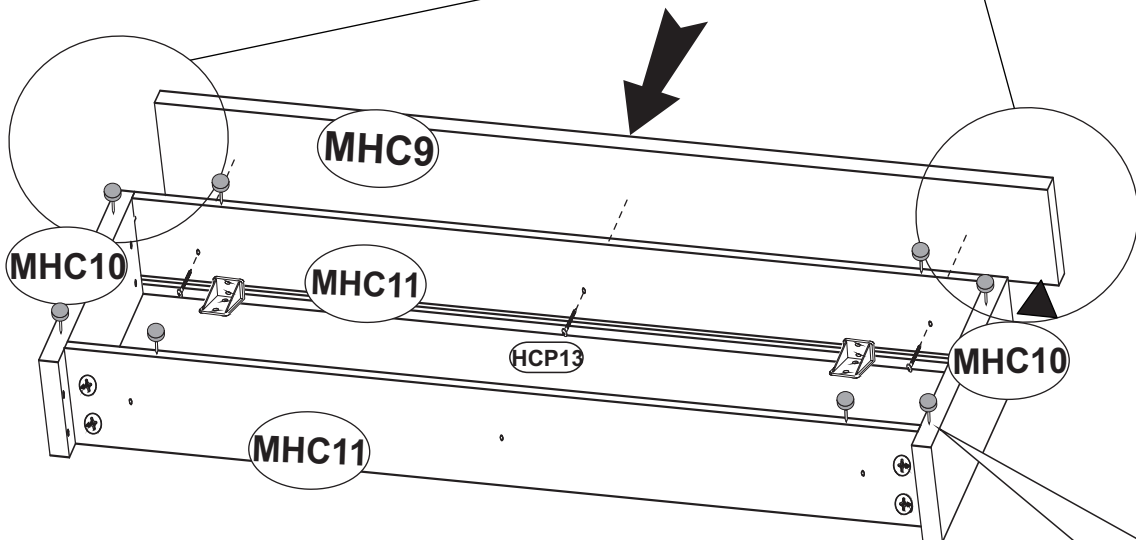
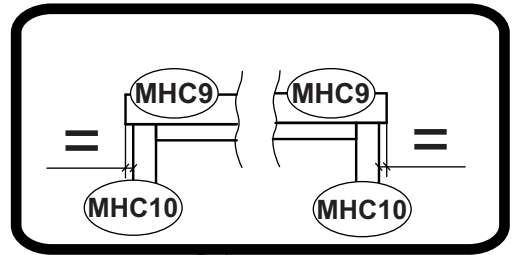
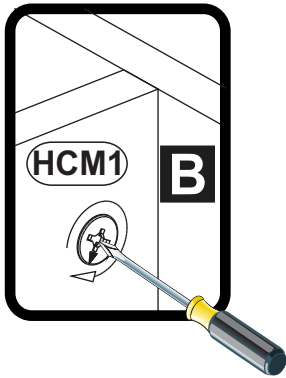
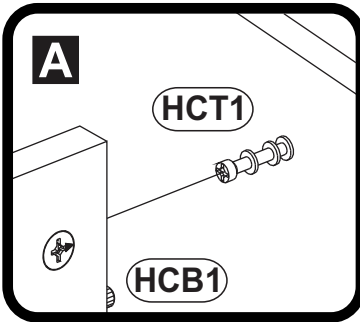
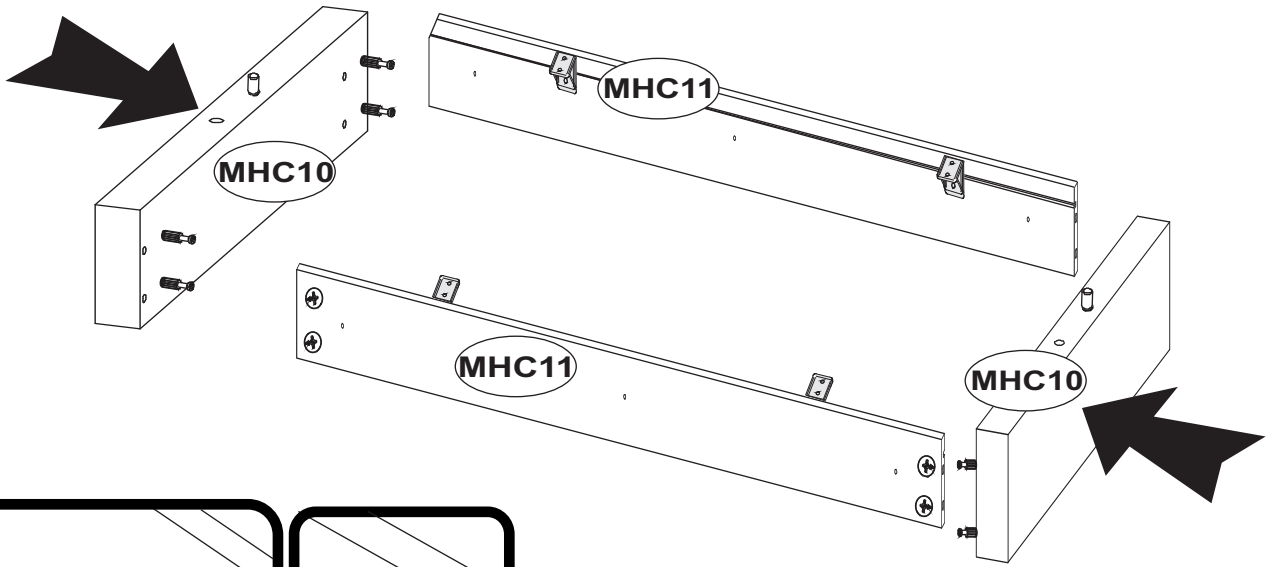

HCP13		1012
	4x30	x3
HCF36		1305
	4x30	x8

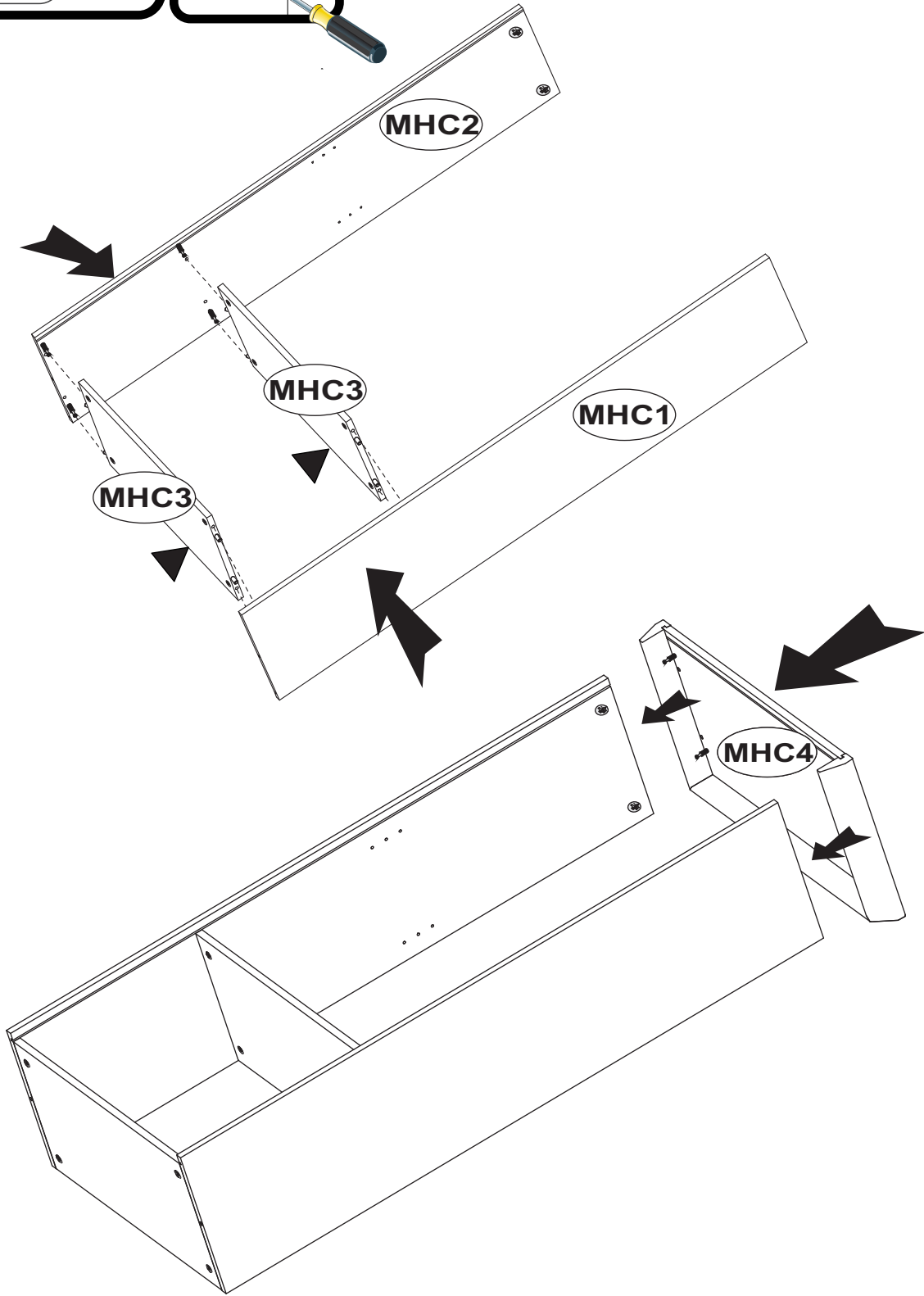
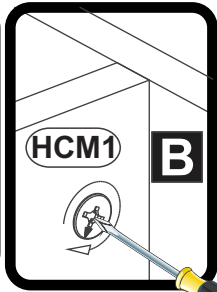
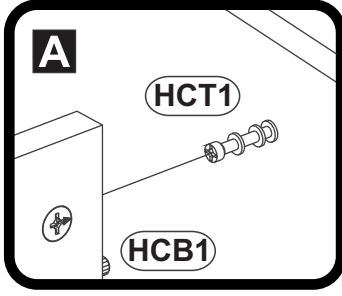

7



8

HCS3 	1011
3,5x13	x8
HCP6 	1056
3x20	x8
HCJ23 	1302
	x10
HCF1 	1415
	x4

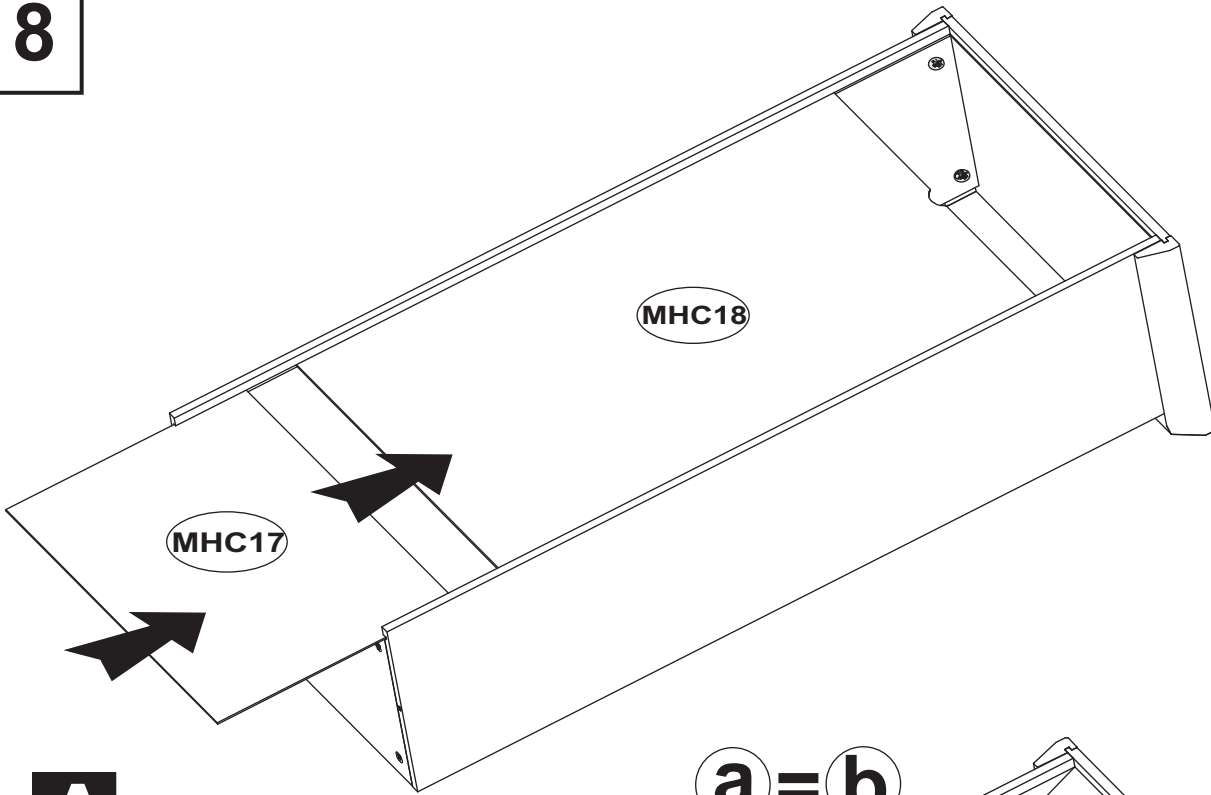

A

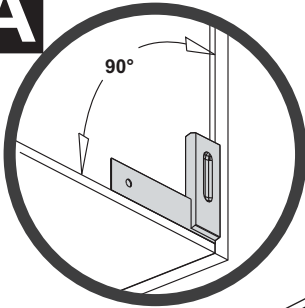

a = b

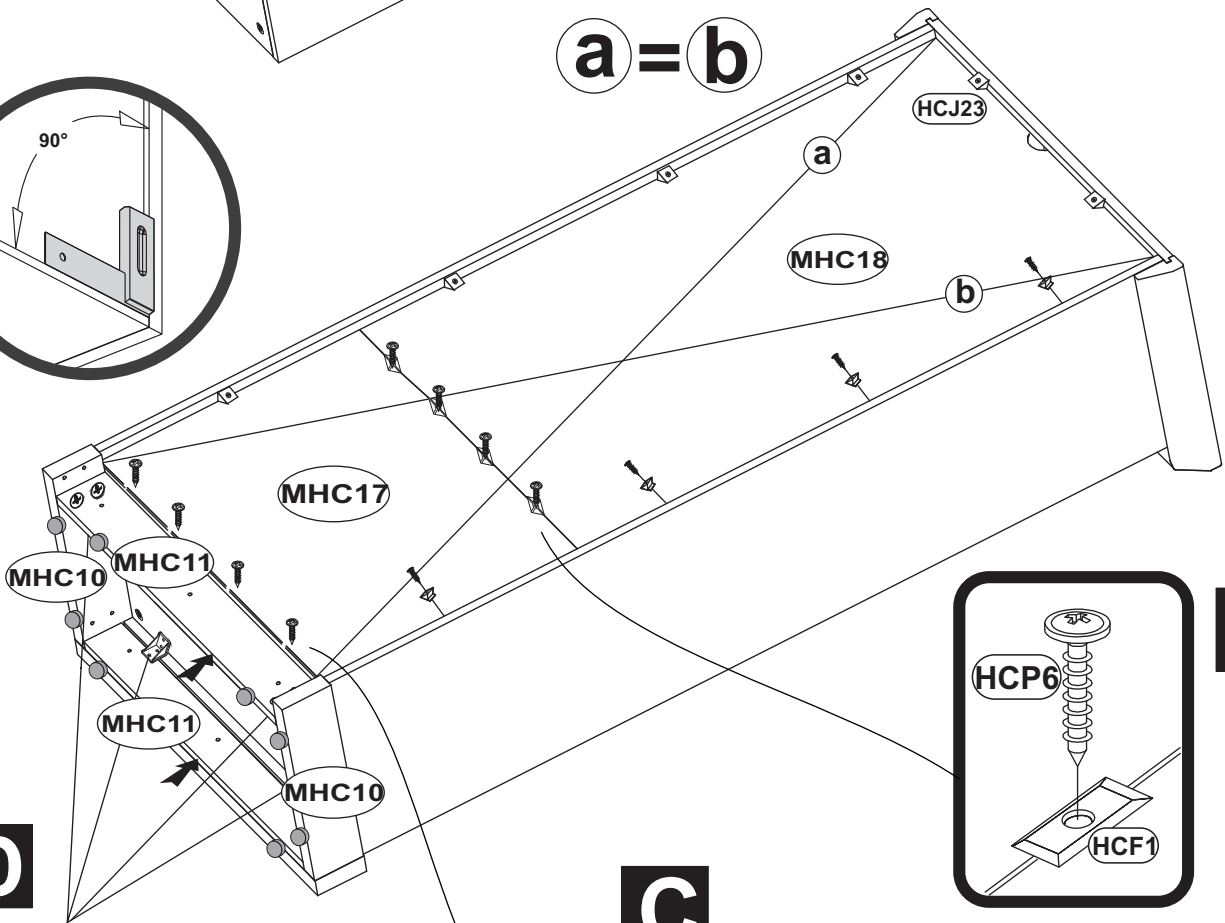

B

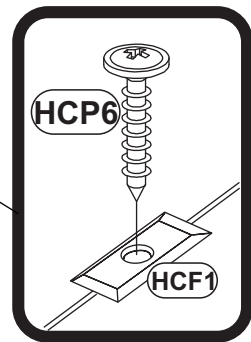

D

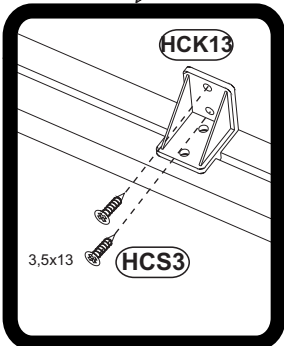

B

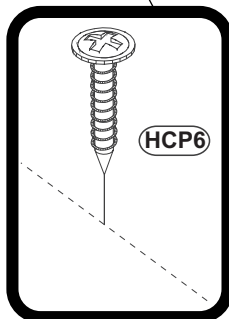

C

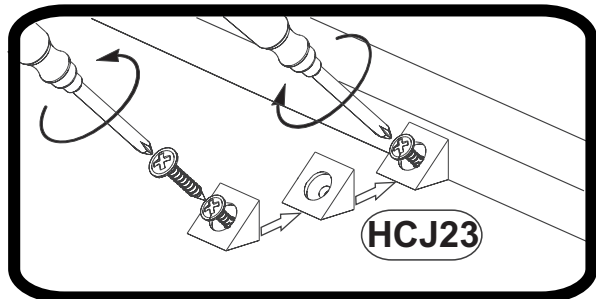

9

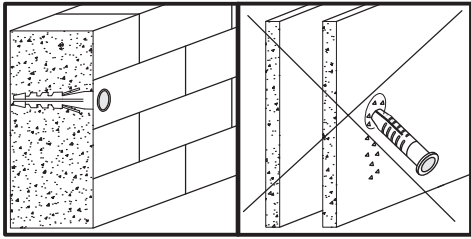

HCS3		1011
	3,5x13	x20
HCW1		1289
		x4
HCJ11		1267
		x1
HCC6		14217
	φ20	x8

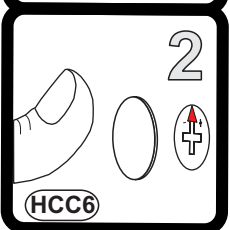
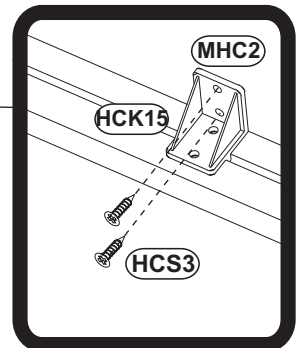
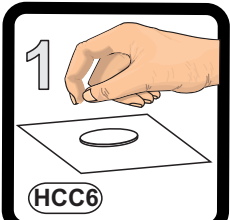
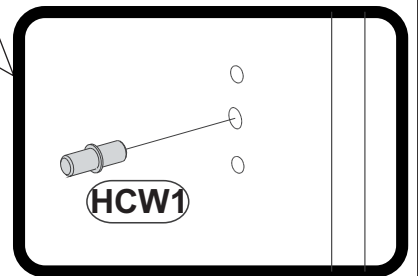
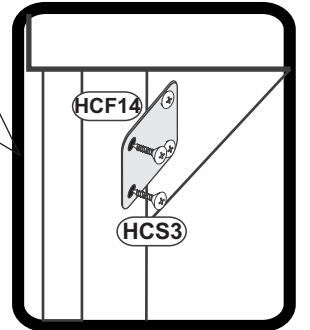
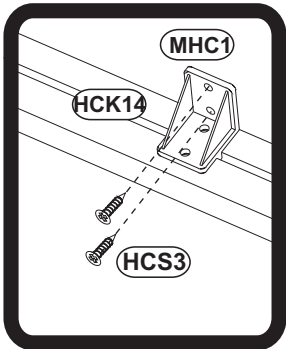
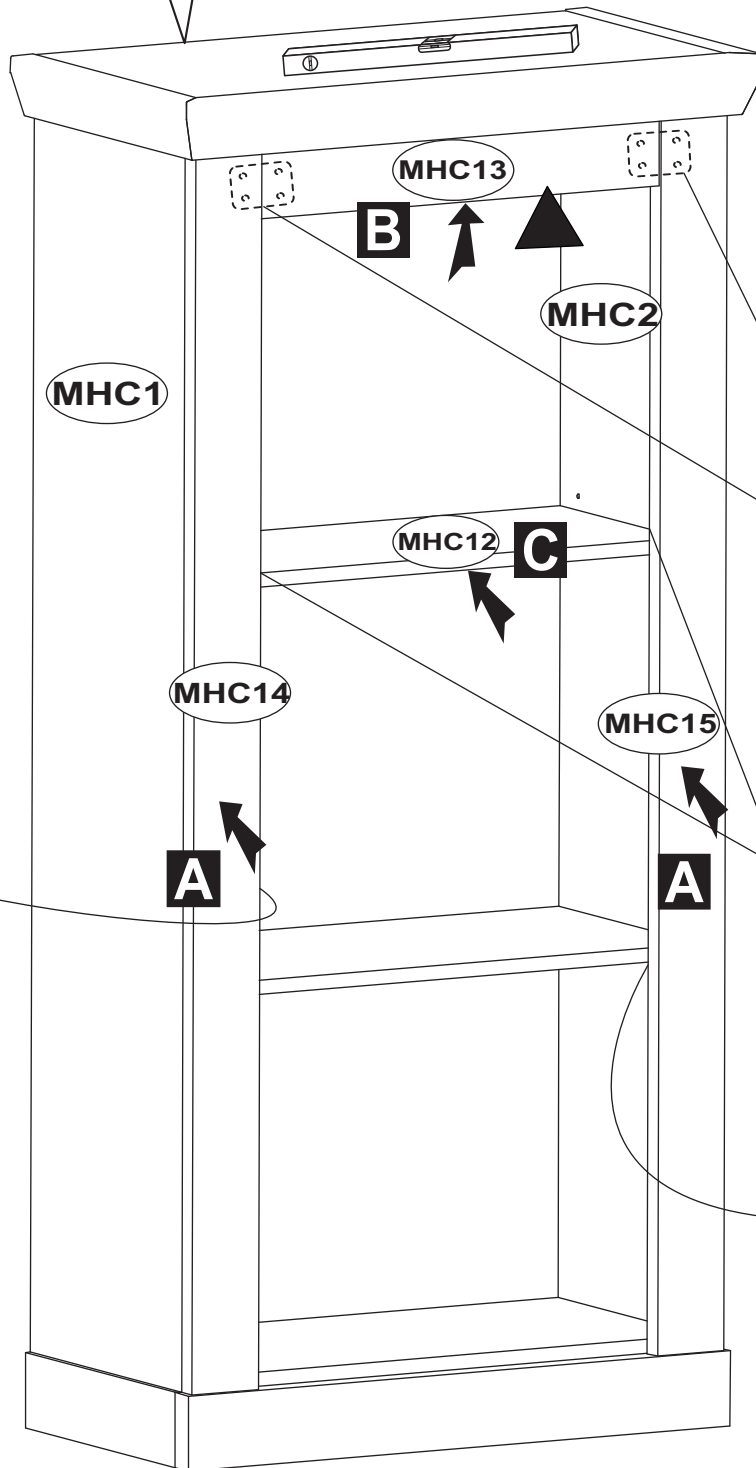
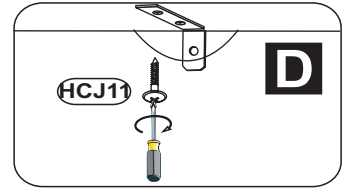
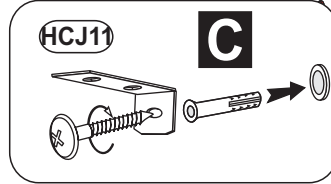
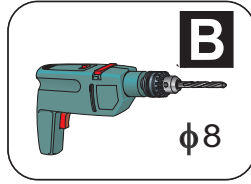
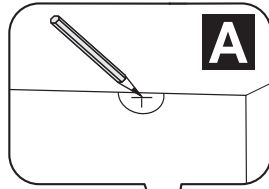

10

OPTION L

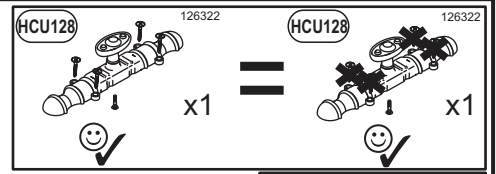
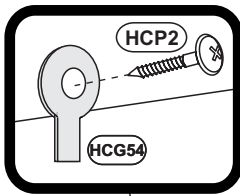
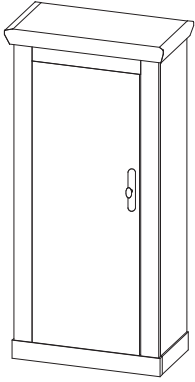

HCG54		126680	x1
HCP2		1014	3,5x13 x1
HCA6		2549	WPM 4x22 x2

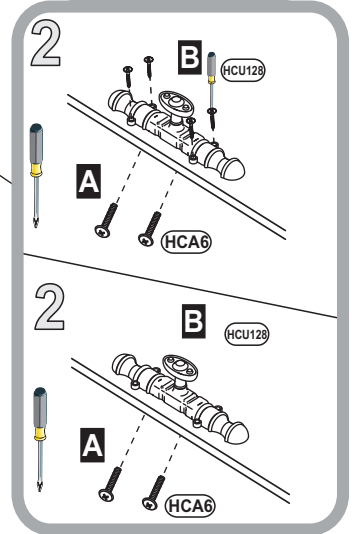
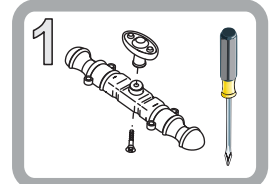
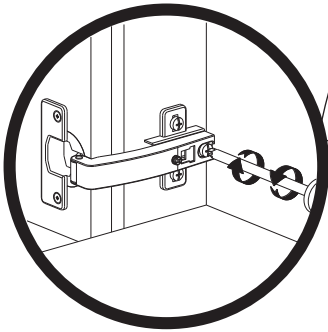
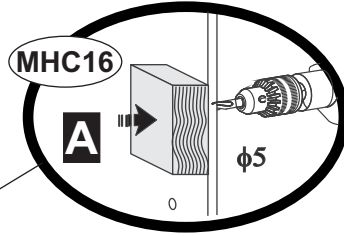
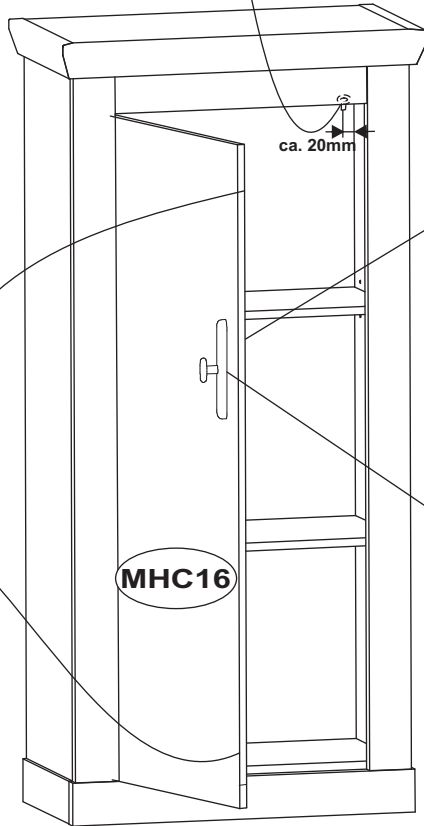

OPTION R

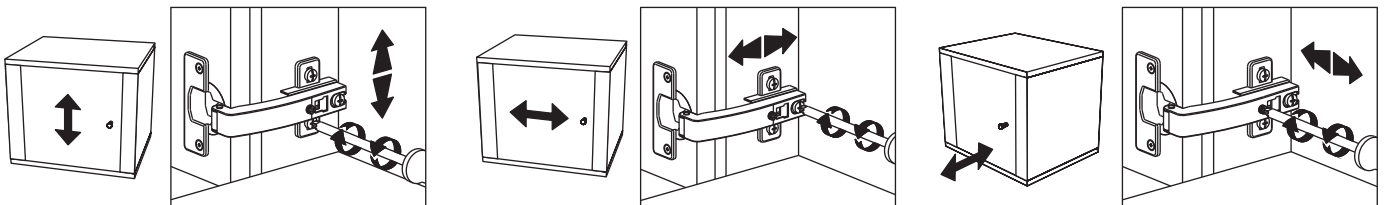
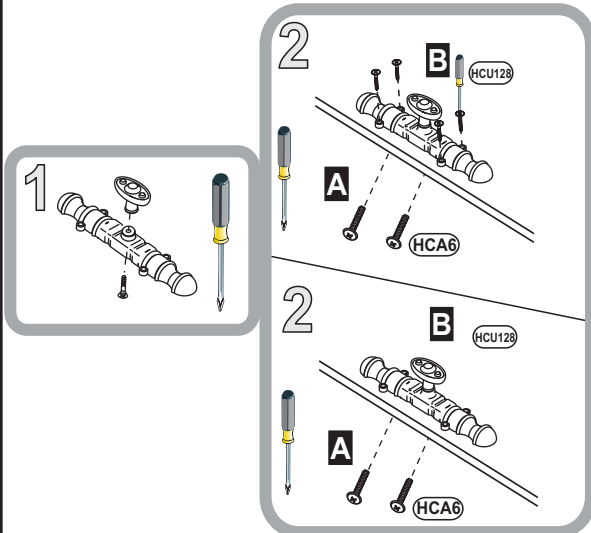
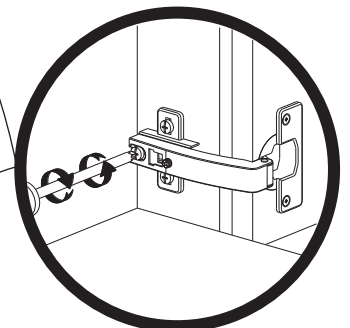
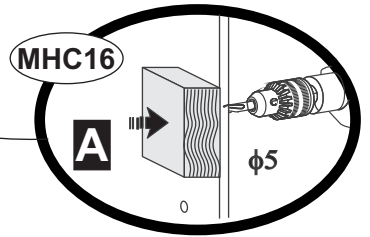
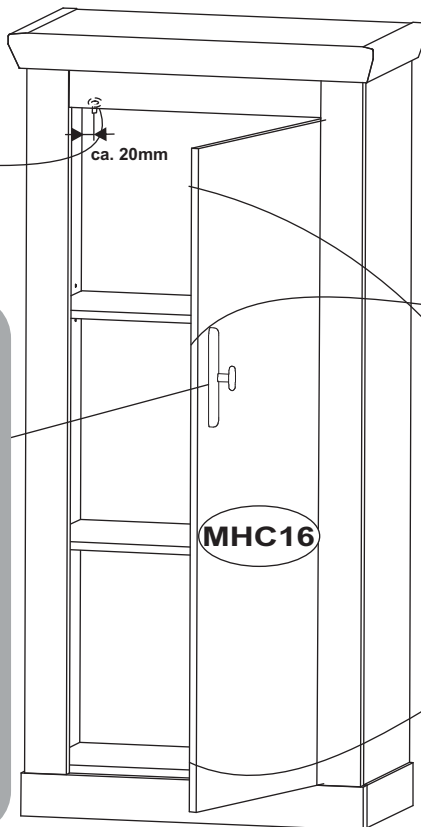
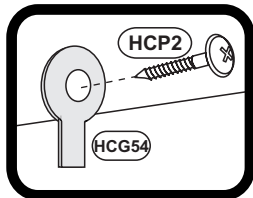
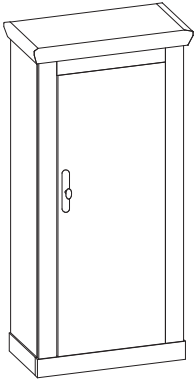

FLORENZ 41M

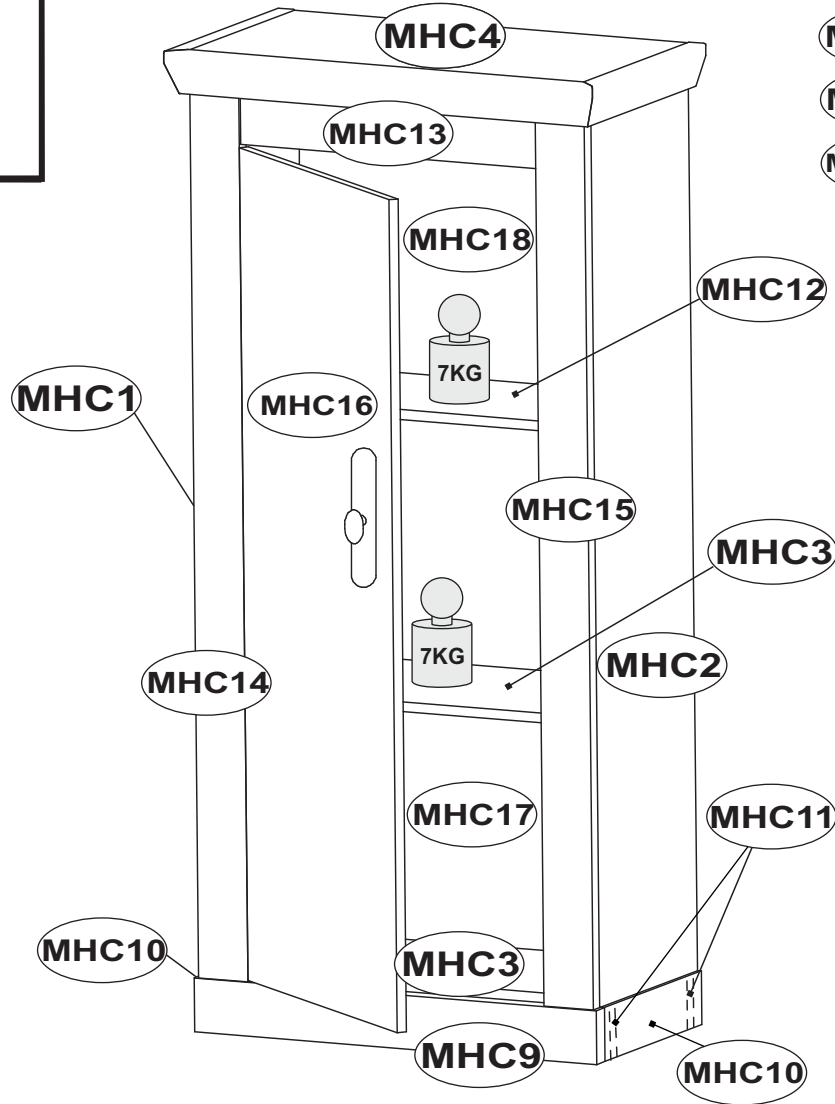
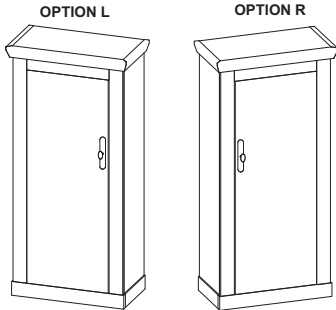

max.



- MHC3
- MHC4
- MHC12

D **Unser Direktservice für Beschlagteile**
Sollte Ihnen ein Beschlagteil fehlen, können Sie diese Servicekarte direkt an die untenstehende Adresse mailen. Wir können allerdings nur Beschlagteile auf diesem Wege verschicken. Sollten Sie eine andere Beanstandung an Ihrem Möbelstück haben, so wenden Sie sich bitte direkt an Ihr Möbelhaus.

GB **Our direct order service for fitting**
If a fitting part is missing, you can e-mail this service card directly to the address below. However, we can only send fitting parts in this way. If you have any other cause for complaint concerning your item of furniture, please contact your furniture store directly.

CZ **Naše přímé služby pro kování**
Chybí-li vám nějaký díl z kování, můžete tuto servisní kartu odeslat e-mailem přímo na níže uvedenou adresu. Touto cestou však můžeme rozesílat jen díly kování. Pokud byste reklamovali jiný díl nábytku, obraťte se přímo na svého prodejce nábytku.

F **Bien étudier la notice de montage**
S'il vous manque une ferrure, veuillez envoyer directement la présente carte service à l'adresse e-mail indiquée ci-dessous. Cependant, ceci nous permet uniquement d'envoyer des ferrures. Pour tout autre type de réclamation concernant votre meuble, veuillez contacter directement votre magasin d'ameublement.

I **Il nostro servizio diretto per l'ordine della ferramenta**
Qualora Vi dovesse mancare un pezzo di fissaggio, allora Vi preghiamo di inviare questa carta di servizio immediatamente all'indirizzo sottostante. Possiamo inviare i pezzi di fissaggio solamente per mezzo di questo procedimento. Qualora dovreste avere qualche altra reclamazione in merito al mobile, allora Vi preghiamo di rivolgerVi direttamente al Vostro Negozio di mobili.

BG **Нашата директна услуга за обкове**
Ако липсват части от комплекта, попълнете настоящата сервисна карта и ни я изпратете на e-mail адреса, посочен по-долу. По този начин можем да доставяме само липсващи елементи от обкова. Ако установите други дефекти по мебелите, Ви съветваме да се обърнете към мебелната къща/магазин, от който сте закупили стоката.

NL **Onze directservice voor losse onderdelen**
Wanneer er een onderdeel ontbreekt, kunt u deze servicekaart direct aan onderstaand e-mailadres sturen. Wij kunnen langs deze weg echter alleen beslagdelen versturen. Mocht u een ander probleem aan uw meubel hebben, verzoeken wij u contact op te nemen met uw meubeldealer.

PL **Nasz bezpośredni serwis części montażowych**
Jeżeli brakuje części koniecznych do montażu, prosimy o przesłanie nam niniejszej karty serwisowej na niżej podany adres e-mailowy. W ten sposób możemy przesyłać Państwu tylko brakujące części. W przypadku innych reklamacji dotyczących mebla, prosimy zgłosić się do salonu meblowego, w którym został dokonany zakup.

HR **Servis za okove**
U slučaju da nedostaje neki od dijelova molimo vas da na dolje navedenu mail adresu pošaljete ovaj servisni obrazac. Na ovaj način mogu se dostaviti samo okovi. U slučaju da imate dodatne prigovore vezane uz komad namještaja molimo vas da se obratite izravno trgovini namještaja gdje je isti kupljen.

HU **Direktszolgalatunk vasalatok esetén**
Ha hiányzik egy vasalat, ezt a kártyát közvetlenül elküldheti az alább található címre. Azonban csak vasalatosokat tudunk így küldeni. Amennyiben másfajta reklamáció áll fenn bútoráruháztól, forduljon közvetlenül a bútorházhoz.

SK **Náš priamy servis pre časti kovania**
Ak by Vám chýbala nejaká časť kovania, môžete poslať túto servisnú kartu poslať e-mailom na nižšie uvedenú adresu. Diely kovania vieme poslať iba týmto spôsobom. Ak by ste mali inú reklamáciu ohľadom Vašho nábytku, obraťte sa priamo na Vašu predajňu nábytku.

SLO **Naše direktno uslužne storitve za okovje**
Če vam manjka kakšno okovje, lahko to servisno kartico pošljete po e-pošti direktno na spodnji naslov. Po tej poti vam lahko pošljemo samo okovje. Če želite reklamirati kakšen drug del pohištva, se obrnite neposredno na vašo trgovino pohištva.

RO **Serviciu-ul nostru direct pentru feronerie**
În cazul în care vă lipsește o piesă de feronerie puteți să trimiteți direct acest card de service prin e-mail la adresa de mai jos. Noi nu putem expedia piese de feronerie decât pe această cale. Dacă aveți o altă reclamație referitoare la piesa de mobilier, atunci vă rugăm să vă adresați direct la magazinul dvs. de mobiliă.

RUS **Наш прямой сервис для поставок фурнитуры**
Если окажется, что Вам не хватает того или иного элемента фурнитуры, Вы можете отправить сервисную карту по факсу непосредственно на нижеприведенный адрес электронной почты. Однако, таким образом мы можем пересылать лишь фурнитуру. Если же у Вас возникнут иные претензии относительно приобретенной мебели, пожалуйста, обращайтесь непосредственно в организацию, осуществляющую продажу.

S **Vår direktservice för beslagsdelar**
Om du saknar en beslagsdel kan du skicka detta servicekort direkt till e-postadressen som anges nedan. Tänk på att detta är den enda möjligheten att skicka beslagsdelar till dig. Om du vill reklamera din möbel av en annan anledning måste du kontakta ditt möbelhus direkt.

ES **Nuestro servicio directo para accesorios**
Si le falta algún accesorio, puede enviar esta tarjeta de servicio directamente a la siguiente dirección. No obstante, por este método solo podemos enviar accesorios. Si tiene alguna otra objeción sobre su mueble, consulte directamente con su mueblería.

TR **Donatılar için doğrudan servisimiz**
Bir donatınız eksikse bu servis kartını doğrudan aşağıda bulunan adrese doğrudan mail yazabilirsiniz. Sadece bu yolla donatıları gönderebiliriz. Mobilyanızda başka şikayetleriniz varsa lütfen doğrudan mobilya satıcınıza danışın.

MHC1	1361	320	15	1/1
MHC2	1361	320	15	1/1
MHC3	611	299	15	1/1
MHC4	699	370,5	65	1/1
MHC9	655	80	28	1/1
MHC10	317	80	28	1/1
MHC11	598	80	15	1/1

MHC12	610	267	15	1/1
MHC13	483	120	18	1/1
MHC14	1361	80	22	1/1
MHC15	1361	80	22	1/1
MHC16	1235	477	15	1/1
MHC17	421	623	3	1/1
MHC18	945	623	3	1/1

FLORENZ 41M

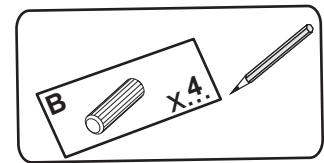
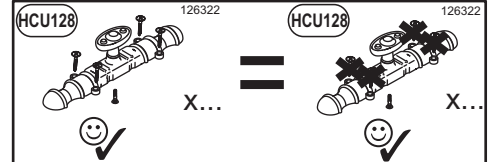
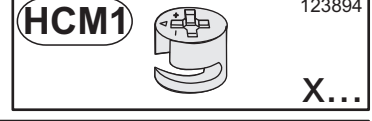
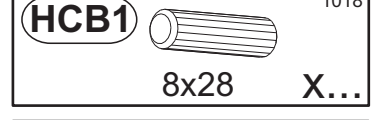
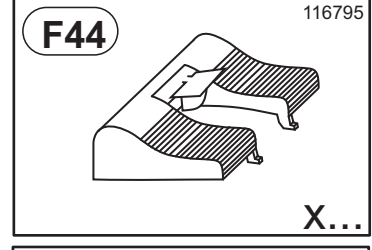
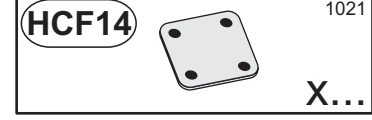
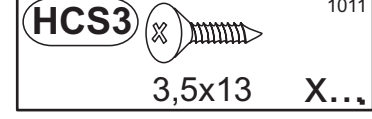
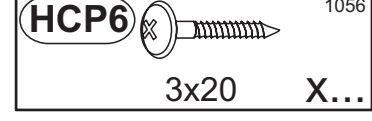
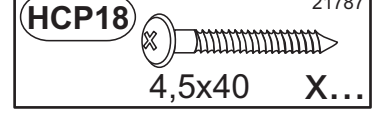
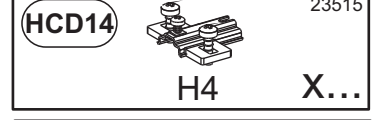
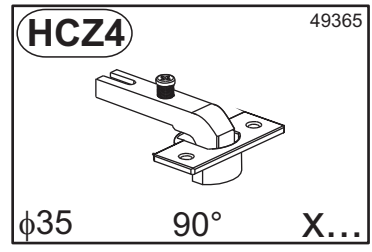
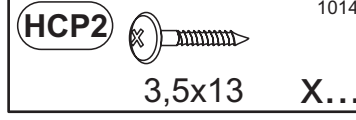
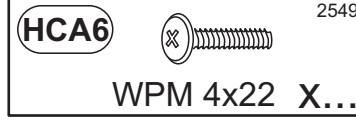
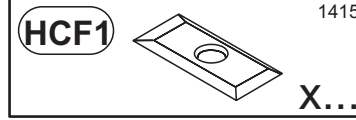
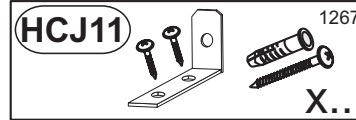
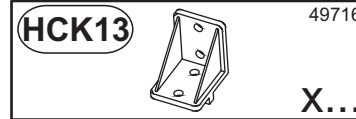
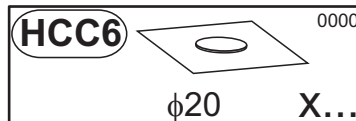
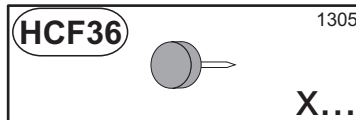
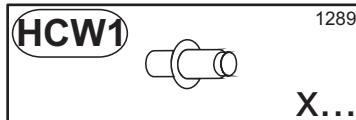
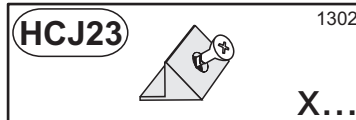
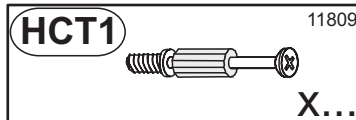

D Unser Direktservice für Beschlagteile
 Sollte Ihnen ein Beschlagteil fehlen, können Sie diese Servicekarte direkt an die untenstehende Adresse mailen. Wir können allerdings nur Beschlagteile auf diesem Wege verschicken. Sollten Sie eine andere Beanstandung an Ihrem Möbelstück haben, so wenden Sie sich bitte direkt an Ihr Möbelhaus.

GB Our direct order service for fitting
 If a fitting part is missing, you can e-mail this service card directly to the address below. However, we can only send fitting parts in this way. If you have any other cause for complaint concerning your item of furniture, please contact your furniture store directly.

CZ Naše primé služby pro kování
 Chybí-li vám nějaký díl z kování, můžete tuto servisní kartu odeslat e-mailem přímo na níže uvedenou adresu. Touto cestou však můžeme rozesílat jen díly kování. Pokud byste reklamovali jiný díl nábytku, obraťte se přímo na svého prodejce nábytku.

F Bien étudier la notice de montage
 Si l'un des éléments de montage est manquant, vous pouvez adresser directement à l'adresse e-mail indiquée ci-dessous. Cependant, ceci nous permet uniquement d'envoyer des ferrures. Pour tout autre type de réclamation concernant votre meuble, veuillez contacter directement votre magasin d'aménagement.

I Il nostro servizio diretto per l'ordine della ferramenta
 Qualora Vi dovesse mancare un pezzo di fissaggio, allora Vi preghiamo di inviare questa carta di servizio immediatamente all'indirizzo sottostante. Possiamo inviare i pezzi di fissaggio solamente per mezzo di questo procedimento. Qualora doveste avere qualche altra reclamazione in merito al mobile, allora Vi preghiamo di rivolgerVi direttamente al Vostro Negozio di mobili.

BG Нашата директна услуга за обкова
 Ако липсват части от комплекта, попълнете настоящата сервисна карта и ни я изпратете на e-mail адреса, посочен по-долу. По този начин можем да доставяме само липсващи елементи от обкова. Ако установите други дефекти по мебелите, Ви съветваме да се обърнете към мебелната къща/магазин, от който сте закупили стоката.

NL Onze directservice voor losse onderdelen
 Wanneer er een onderdeel ontbreekt, kunt u deze servicekaart direct aan onderstaand e-mailadres sturen. Wij kunnen lange deze weg echter alleen beslagdelen versturen. Mocht u een ander probleem aan uw meubel hebben, verzoeken wij u contact op te nemen met uw meubeldealer.

PL Nasz bezpośredni serwis części montażowych
 Jeżeli brakuje części koniecznych do montażu, prosimy o przesłanie nam niniejszej karty serwisowej na niżej podany adres e-mailowy. W ten sposób możemy przesyłać Państwu tylko brakujące części. W przypadku innych reklamacji dotyczących mebla, prosimy zgłosić się do salonu meblowego, w którym został dokonany zakup.

HR Servis za okove
 U slučaju da nedostaje neki od dijelova molimo vas da na dolje navedenu mail adresu pošaljete ovaj servisni obrazac. Na ovaj način mogu se dostaviti samo okovi. U slučaju da imate dodatne prigovore vezane uz komad namještaja molimo vas da se obratite izravno trgovini namještaja gdje je isti kupljen.

HU Direktszolgalatunk vasalatok esetén
 Ha hiányzik egy vasalat, ezt a kártyát közvetlenül elküldheti az alább található címre. Azonban csakis vasalatokat tudunk így küldeni. Amennyiben másfajta reklamáció áll fenn bútorárbaját illetően, forduljon közvetlenül a bútorhához.

SK Naš priamy servis pre časti kovania
 Ak by Vám chýbala nejaká časť kovania, môžete poslať túto servisnú kartu pošťou e-mailom na nižšie uvedenú adresu. Diely kovania vieme poslať iba týmto spôsobom. Ak by ste mali inú reklamáciu ohľadom Vášho nábytku, obráťte sa priamo na Vašu predajňu nábytku.

SLO Naše direktne uslužne storitve za okovje
 Če vam manjka kakšno okovje, lahko to servisno kartico pošljete po e-pošti direktno na spodnji naslov. Po tej poti vam lahko pošljemo samo okovje. Če želite reklamirati kakšen drug del pohištva, se obrnite neposredno na vašo trgovino pohištva.

RO Service-ul nostru direct pentru feronerie
 In cazul in care va lipseste o piesa de feronerie puteti sa trimiteți direct acest card de service prin e-mail la adresa de mai jos. Noi nu putem expedia piese de feronerie decât pe această cale. Dacă aveți o altă reclamație referitoare la piesa de mobilier, atunci vă rugăm să vă adresați direct la magazinul dvs. de mobilă.

RUS Наш прямой сервис для поставок фурнитуры
 Если окажется, что Вам не хватает того или иного элемента фурнитуры, Вы можете отправить сервисную карту по факсу непосредственно на нижеприведенный адрес электронной почты. Однако, таким образом мы можем пересылать лишь фурнитуру. Если же у Вас возникнут иные претензии относительно приобретенной мебели, пожалуйста, обращайтесь непосредственно в организацию, осуществившую продажу.

S Vår direktservice för beslagsdelar
 Om du saknar en beslagsdel kan du skicka detta servicekort direkt till e-postadressen som anges nedan. Tank på att detta är den enda möjligheten att skicka beslagsdelar till dig. Om du vill reklamera din möbel av en annan anledning måste du kontakta ditt möbelför direkt.

ES Nuestro servicio directo para accesorios
 Si le falta algún accesorio, puede enviar esta tarjeta de servicio directamente a la siguiente dirección. No obstante, por este método solo podemos enviar accesorios. Si tiene alguna otra objeción sobre su mueble, consulte directamente con su mueblería.

TR Donatılar için doğrudan servisimiz
 Bir donatınız eksikse bu servis kartını doğrudan aşığada bulunan adrese doğrudan mail yazabilirsiniz. Sadece bu yolla donatıları gönderebiliriz. Mobilyanızda başka şikayetleriniz varsa lütfen doğrudan mobilya satıcınıza danışın.

FLORENZ 71M

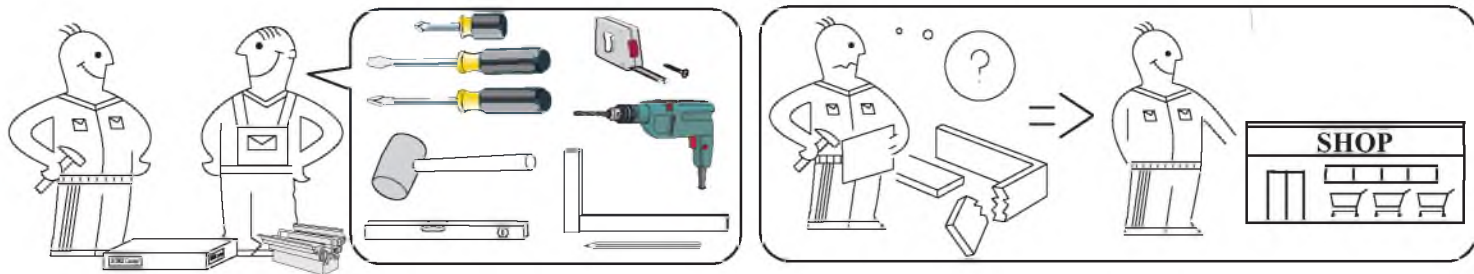
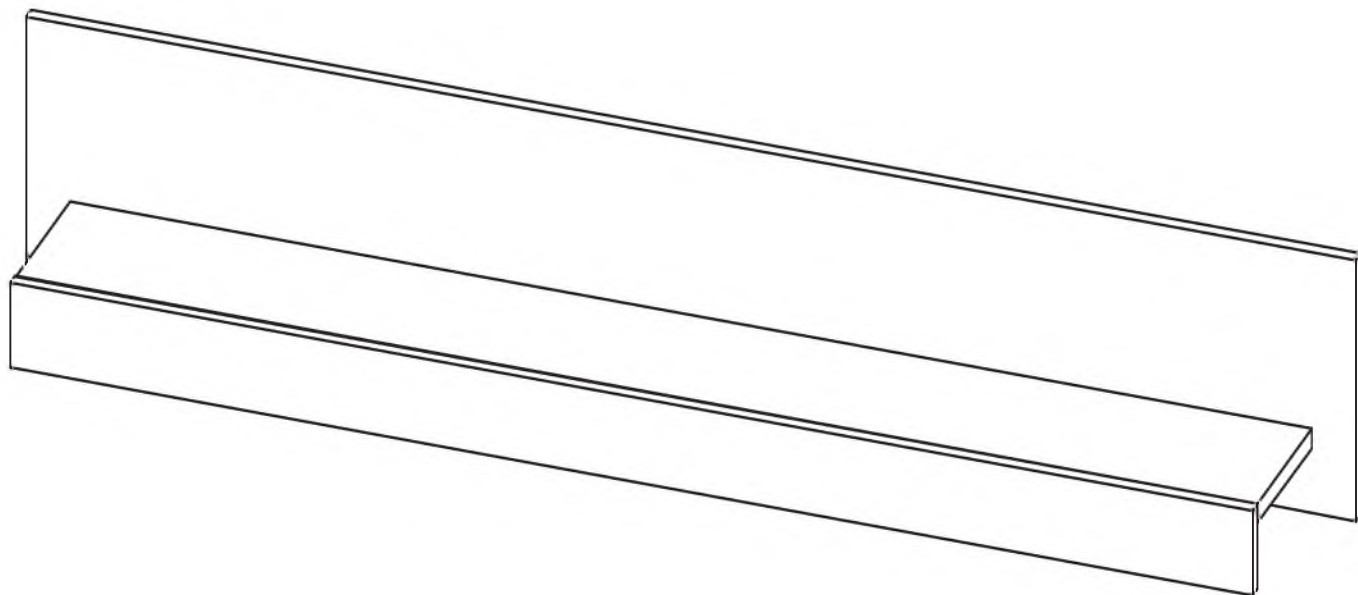
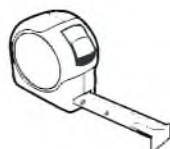

FLORENZ 71M

max.

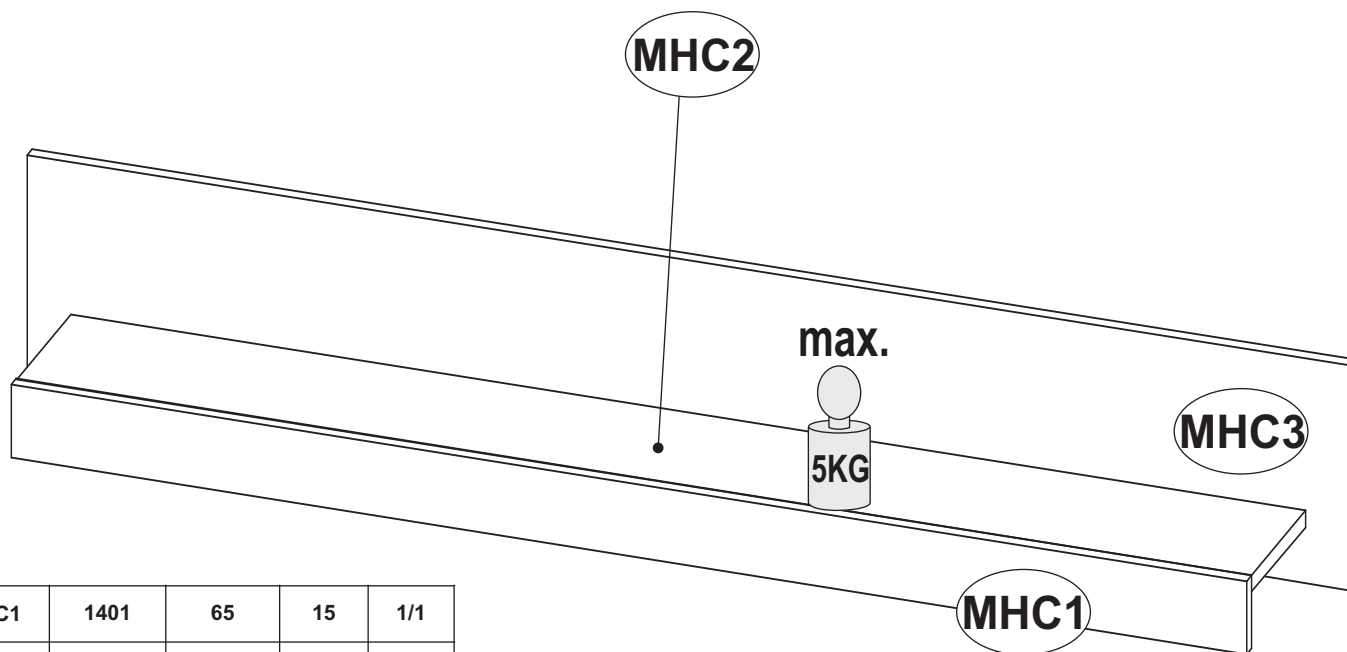

MHC1	1401	65	15	1/1
MHC2	1400	169	15	1/1
MHC3	1500	200	15	1/1

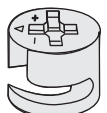
HCM1  123894
x5

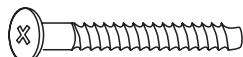
HCK2  1311
7x70 x6

HCL15  6463
x2

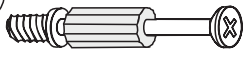
HCT1  11809
x5

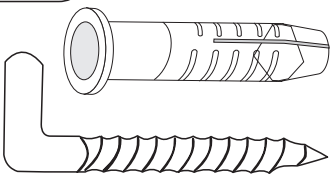
HCT10  1274
8281
x2

HCC6  00000
φ20 x5

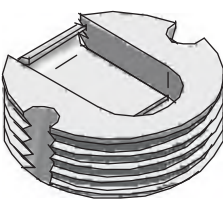
HCZ10  8704
x2

HCE6  1007
ES 6x9,5 x4

1

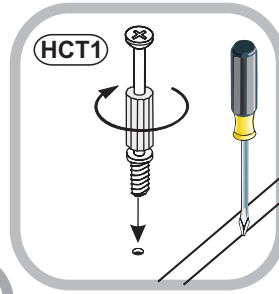
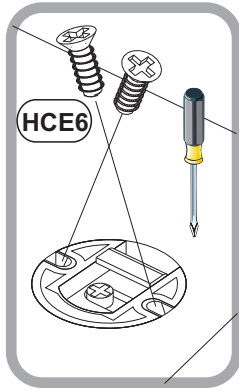

- HCZ10 8704 x2
- HCE6 1007 ES 6x9,5 x4
- HCM1 123894 x5
- HCT1 11809 x5

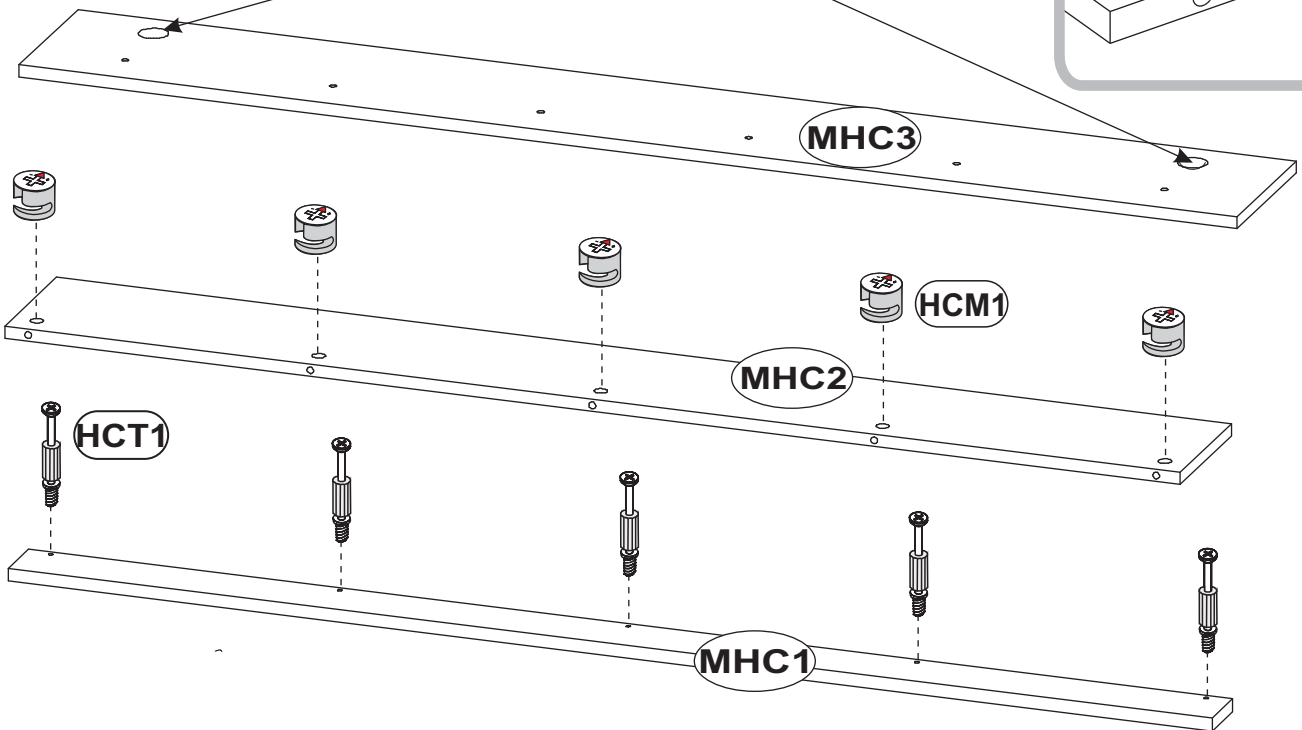
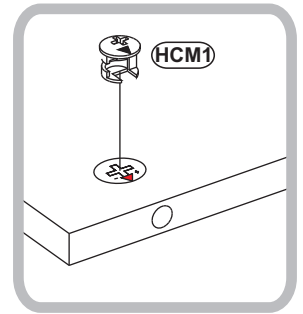
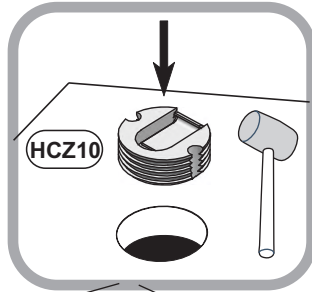

2

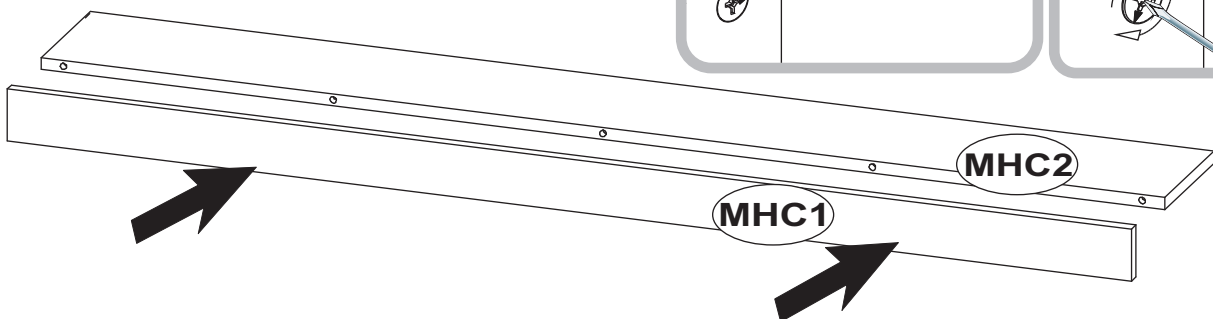
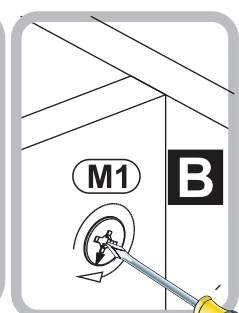
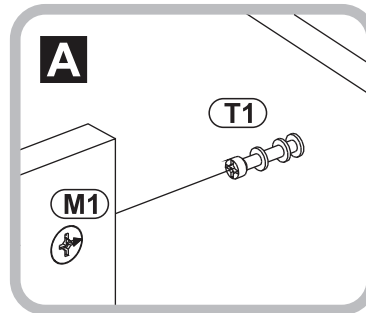

3

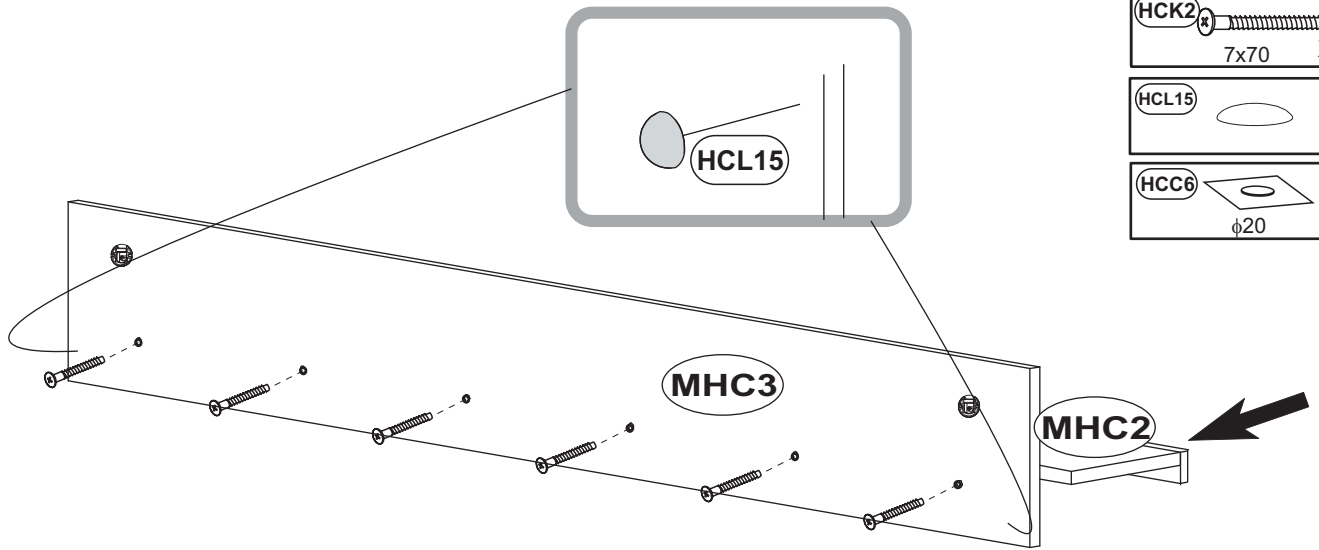

- HCK2** 7x70 x6
- HCL15** 6463 x2
- HCC6** 00000 φ20 x5

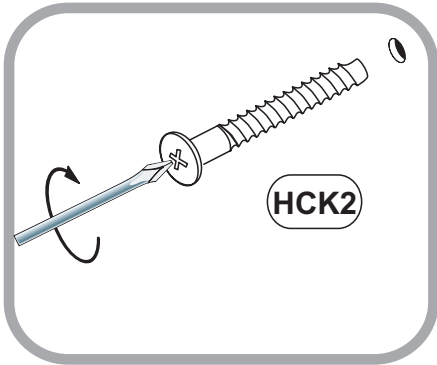

- 1 **HCC6**
- 2 **HCC6**

4

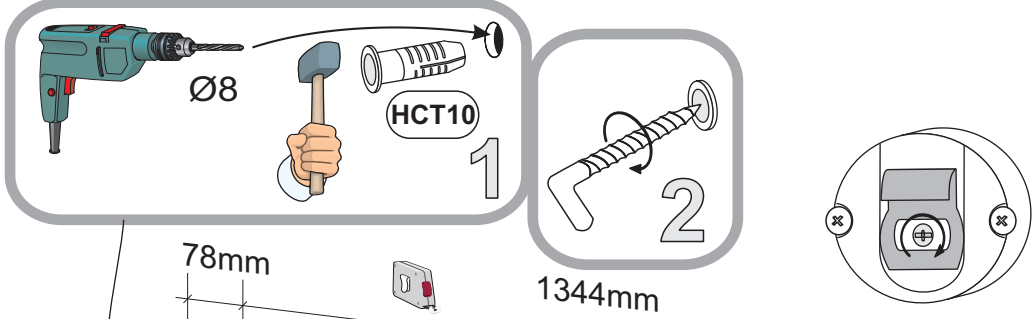

- HCT10** 1274 8281 x2

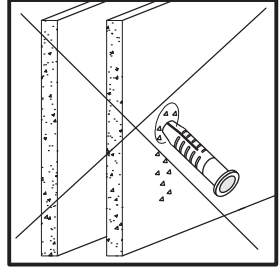
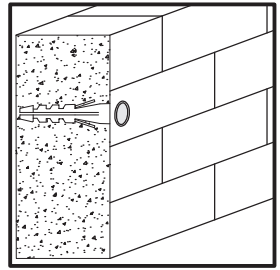
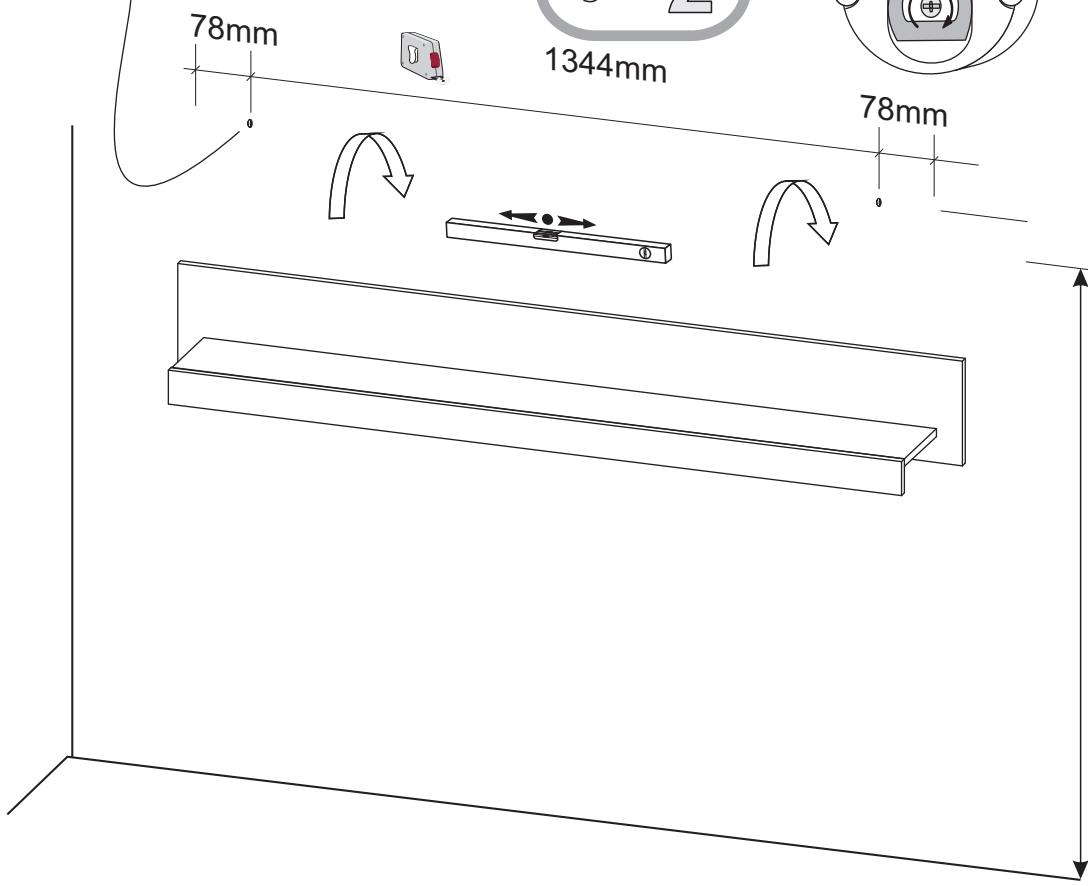

FLORENZ 71M

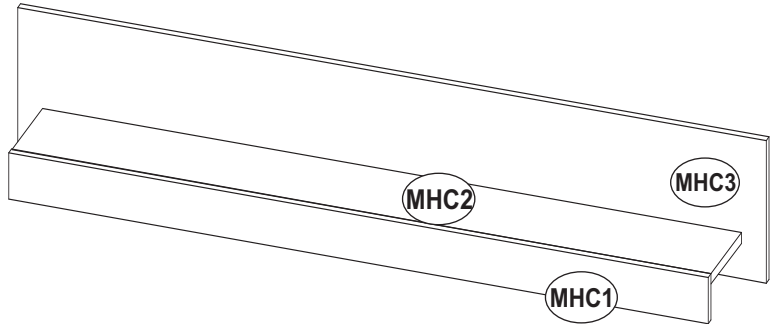

Unser Direktservice für Beschlagteile

D Sollte Ihnen ein Beschlagteil fehlen, können Sie diese Servicekarte direkt an die untenstehende Adresse mailen. Wir können allerdings nur Beschlagteile auf diesem Wege verschicken. Sollten Sie eine andere Beanstandung an Ihrem Möbelstück haben, so wenden Sie sich bitte direkt an Ihr Möbelhaus.

Our direct order service for fitting

GB If a fitting part is missing, you can e-mail this service card directly to the address below. However, we can only send fitting parts in this way. If you have any other cause for complaint concerning your item of furniture, please contact your furniture store directly.

Naše přímé služby pro kování

CZ Chybí-li vám nějaký díl z kování, můžete tuto servisní kartu odeslat e-mailem přímo na níže uvedenou adresu. Touto cestou však můžeme zoslat jen díly kování. Pokud byste reklamovali jiný díl nábytku, obraťte se přímo na svého prodejce nábytku.

Bien étudier la notice de montage

F S'il vous manque une ferrure, veuillez envoyer directement la présente carte service à l'adresse e-mail indiquée ci-dessous. Cependant, ceci nous permet uniquement d'envoyer des ferrures. Pour tout autre type de réclamation concernant votre meuble, veuillez contacter directement votre magasin d'ameublement.

Il nostro servizio diretto per l'ordine della ferramenta

I Qualora Vi dovesse mancare un pezzo di fissaggio, allora Vi preghiamo di inviare questa carta di servizio immediatamente all'indirizzo sottostante. Possiamo inviare i pezzi di fissaggio solamente per mezzo di questo procedimento. Qualora dovesse avere qualche altra reclamazione in merito al mobile, allora Vi preghiamo di rivolgerVi direttamente al Vostro Negozio di mobili.

Нашата директна услуга за обков

BG Ако липсват части от комплекта, попълнете настоящата сервисна карта и ни я изпратете на e-mail адреса, посочен по-долу. По този начин можем да доставяме само липсващи елементи от обкова. Ако установите други дефекти по мебелите, Ви съветваме да се обръщате към мебелната къща/магазин, от който сте закупили стоката.

Onze directservice voor losse onderdelen

NL Wanneer er een onderdeel ontbreekt, kunt u deze servicekaart direct aan onderstaand e-mailadres sturen. Wij kunnen langs deze weg echter alleen beslagdelen versturen. Mocht u een ander probleem aan uw meubel hebben, verzoeken wij u contact op te nemen met uw meubeldealer.

Nasz bezpośredni serwis części montażowych

PL Jeżeli brakuje części koniecznych do montażu, prosimy o przesłanie nam niniejszej karty serwisowej na niżej podany adres e-mailowy. W ten sposób możemy przelać Państwu tylko brakujące części. W przypadku innych reklamacji dotyczących mebla, prosimy zgłosić się do salonu meblowego, w którym został dokonany zakup.

Servis za okove

HR U slučaju da nedostaje neki od dijelova molimo vas da na dolje navedenu mail adresu pošaljete ovaj servisni obrazac. Na ovaj način mogu se dostaviti samo okovi. U slučaju da imate dodatne prigovore vezane uz komad namještaja molimo vas da se obratite izravno trgovini namještaja gdje je isti kupljen.

Direktszolpálatunk vasalatok esetén

HU Ha hiányzik egy vasalat, ezt a kártyát közvetlenül elküldheti az alább található címre. Azonban csakis vasalatoskat tudunk így küldeni. Amennyiben másfajta reklamációt áll fenn bútoráratját illetően, forduljon közvetlenül a bútorházhoz.

Náš priamy servis pre časti kovania

SK Ak by Vám chýbala nejaká časť kovania, môžete poslať túto servisnú kartu poslať e-mailom na nižšie uvedenú adresu. Diely kovania vieme poslať iba týmto spôsobom. Ak by ste mali inú reklamáciu ohľadom Vášho nábytku, obráťte sa priamo na Vašu predajňu nábytku.

Naše direktne uslužne storitve za okovje

SLO Če vam manjka kakšno okovje, lahko to servisno kartico pošljete po e-pošti direktno na spodnji naslov. Po tej poti vam lahko pošljemo samo okovje. Če želite reklamirati kakšen drug del pohištva, se obrnite neposredno na vašo trgovino pohištva.

Servicio-ul nostru direct pentru feronerie

RO In cazul in care va lipsesc o piesa de feronerie puteti sa trimiteți direct acest card de service prin e-mail la adresa de mai jos. Noi nu putem expedia piese de feronerie decât pe această cale. Dacă aveți o altă reclamație referitoare la piesa de mobilier, atunci vă rugăm să vă adresați direct la magazinul dvs. de mobilă.

Наш прямой сервис для поставок фурнитуры

RUS Если окажется, что Вам не хватает того или иного элемента фурнитуры, Вы можете отправить сервисную карту по факсу непосредственно на нижеприведенный адрес электронной почты. Однако, таким образом мы можем пересылать лишь фурнитуру. Если же у Вас возникнут иные претензии относительно приобретенной мебели, пожалуйста, обращайтесь непосредственно в организацию, осуществившую продажу.

Vr direktservice för beslagsdelar

S Om du saknar en beslagsdel kan du skicka detta servicekort direkt till e-postadressen som anges nedan. Tank på att detta är den enda möjligheten att skicka beslagsdelar till dig. Om du vill reklamera din möbel av en annan anledning mlste du kontakta ditt möbelhus direkt.

Nuestro servicio directo para accesorios

ES Si le falta algún accesorio, puede enviar esta tarjeta de servicio directamente a la siguiente dirección. No obstante, por este método solo podemos enviar accesorios. Si tiene alguna otra objeción sobre su mueble, consulte directamente con su mueblería.

Donatilar için doğrudan servisimiz

TR Bir donatınız eksikse bu servis kartını doğrudan aşağıda bulunan adrese doğrudan mail yazabilirsiniz. Sadece bu yolla donatılar gönderiliriz. Mobilyanızda başka şikayetleriniz varsa lütfen doğrudan mobilya satıcınıza danışın.

MHC1	1401	65	15	1/1
MHC2	1400	169	15	1/1
MHC3	1500	200	15	1/1

FLORENZ 71M

D

Unser Direktservice für Beschlagteile
Sollte Ihnen ein Beschlagteil fehlen, können Sie diese Servicekarte direkt an die untenstehende Adresse mailen. Wir können allerdings nur Beschlagteile auf diesem Wege verschicken. Sollten Sie eine andere Beanstandung an Ihrem Möbelstück haben, so wenden Sie sich bitte direkt an Ihr Möbelhaus.

Our direct order service for fitting
If a fitting part is missing, you can e-mail this service card directly to the address below. However, we can only send fitting parts in this way. If you have any other cause for complaint concerning your item of furniture, please contact your furniture store directly.

GB

CZ

Naše primé služby pro kování
Chybi-li vám nějaký díl z kování, můžete tuto servisní kartu odeslat e-mailem přímo na níže uvedenou adresu. Touto cestou však můžeme rozesílat jen díly kování. Pokud byste reklamovali jiný díl nábytku, obraťte se přímo na svého prodejce nábytku.

Bien étudier la notice de montage

F

S'il vous manque une ferrure, veuillez envoyer directement la présente carte service à l'adresse e-mail indiquée ci-dessous. Cependant, ceci nous permet uniquement d'envoyer des ferrures. Pour tout autre type de réclamation concernant votre meuble, veuillez contacter directement votre magasin d'ameublement.

Il nostro servizio diretto per l'ordine della ferramenta

I

Qualora Vi dovesse mancare un pezzo di fissaggio, allora Vi preghiamo di inviare questa carta di servizio immediatamente all'indirizzo sottostante. Possiamo inviare i pezzi di fissaggio solamente per mezzo di questo procedimento. Qualora dovete avere qualche altra reclamazione in merito al mobile, allora Vi preghiamo di rivolgerVi direttamente al Vostro Negozio di mobili.

Нашата директна услуга за обкова

BG

Ако липсват части от комплекта, попълнете настоящата сервисна карта и ни я изпратете на e-mail адреса, посочен по-долу. По този начин можем да доставяме само липсващи елементи от обкова. Ако установите други дефекти по мебелите, Ви съветваме да се обърнете към мебелната къща/магазин, от който сте закупили стоката.

Onze directservice voor losse onderdelen

NL

Wanneer er een onderdeel ontbreekt, kunt u deze servicekaart direct aan onderstaand e-mailadres sturen. Wij kunnen lange deze weg echter alleen beslagdelen versturen. Mocht u een ander probleem aan uw meubel hebben, verzoeken wij u contact op te nemen met uw meubeldealer.

Nasz bezpośredni serwis części montażowych

PL

Jeżeli brakuje części koniecznych do montażu, prosimy o przesłanie nam niniejszej karty serwisowej na niżej podany adres e-mailowy. W ten sposób możemy przesłać Państwu tylko brakujące części. W przypadku innych reklamacji dotyczących mebla, prosimy zgłosić się do salonu meblowego, w którym został dokonany zakup.

Служба за обкова

HR

U slučaju da nedostaje neki od dijelova molimo vas da na dolje navedenu mail adresu pošaljete ovaj servisni obrazac. Na ovaj način mogu se dostaviti samo okovi. U slučaju da imate dodatne prigovore vezane uz komad namještaja molimo vas da se obratite izravno trgovini namještaja gdje je isti kupljen.

Direktszolgalatunk vasalatok esetén

HU

Ha hiányzik egy vasalat, ezt a kártyát közvetlenül elküldheti az alább található címre. Azonban csak vasalatoskat tudunk így küldeni. Amennyiben másfajta reklamáció áll fenn bütördarabját illetően, forduljon közvetlenül a bütörházhoz.

Naš priamy servis pre časti kovania

SK

Ak by Vám chýbala nejaká časť kovania, môžete poslať túto servisnú kartu pošlou e-mailom na nižšie uvedenú adresu. Diely kovania vieme poslať iba týmto spôsobom. Ak by ste mali inú reklamáciu ohľadom Vášho nábytku, obráťte sa priamo na Vašu predajňu nábytku.

Naše direktno uslužbne storitve za okovje

SLO

Ce vam manjka kakšno okovje, lahko to servisno kartico pošljete po e-pošti direktno na spodnji naslov. Po tej poti vam lahko pošljemo samo okovje. Če želite reklamirati kakšen drug del pohištva, se obrnite neposredno na vašo trgovino pohištva.

Service-ul nostru direct pentru feronerie

RO

În cazul în care vă lipsește o piesă de feronerie puteți să trimiteți direct acest card de service prin e-mail la adresa de mai jos. Noi nu putem expedia piese de feronerie decât pe această cale. Dacă aveți o altă reclamație referitoare la piesa de mobilier, atunci vă rugăm să vă adresați direct la magazinul dvs. de mobila.

Наш прямой сервис для поставок фурнитуры

RUS

Если окажется, что Вам не хватает того или иного элемента фурнитуры, Вы можете отправить сервисную карту по факсу непосредственно на нижеприведенный адрес электронной почты. Однако, таким образом мы можем пересылать лишь фурнитуру. Если же у Вас возникли иные претензии относительно приобретенной мебели, пожалуйста, обращайтесь непосредственно в организацию, осуществившую продажу.

Vr direktservice för beslagsdelar

S

Om du saknar en beslagsdel kan du skicka detta servicekort direkt till e-postadressen som anges nedan. Tank på att detta är den enda möjligheten att skicka beslagsdelar till dig. Om du vill reklamera din möbel av en annan anledning måste du kontakta ditt möbelfhus direkt.

Nuestro servicio directo para accesorios

ES

Si le falta algún accesorio, puede enviar esta tarjeta de servicio directamente a la siguiente dirección. No obstante, por este método solo podemos enviar accesorios. Si tiene alguna otra objeción sobre su mueble, consulte directamente con su mueblería.

Donatilar için doğrudan servisimiz

TR

Bir donatınız eksikse bu servis kartını doğrudan aşağıda bulunan adrese doğrudan mail yazabilirsiniz. Sadece bu yolla donatıları gönderebiliriz. Mobilyanızda başka şikayetleriniz varsa lütfen doğrudan mobilya satıcınıza danışın.

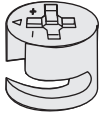
HCM1  123894
X...

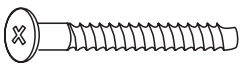
HCK2  1311
7x70 X...

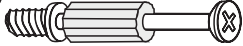
HCT1  11809
X...

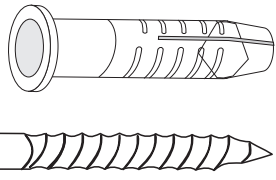
HCT10  1274
8281
X...

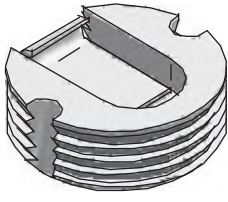
HCZ10  8704
X...

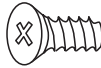
HCE6  1007
ES 6x9,5 X...

HCL15  6463
X...

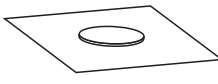
HCC6  00000
φ20 X...

 X4