

LOLLAND

8141/2503  
2501/8142

F/B

210120

- |           |  |           |   |
|-----------|--|-----------|---|
| <b>D</b>  | MONTAGEANLEITUNG<br>BEDIENUNGSANLEITUNG                | <b>GB</b> | ASSEMBLY INSTRUCTIONS<br>INSTRUCTION MANUAL         |
| <b>NL</b> | HANDLEIDING VOOR DE MONTAGE<br>GEBRUIKSAANWIJZING      | <b>PL</b> | INSTRUKCJA MONTAŻU<br>INSTRUKCJA OBSŁUGI            |
| <b>TR</b> | MONTAJ TALIMATI<br>KULLANIM KLAVUZU                    | <b>RU</b> | ИНСТРУКЦИЯ ПО МОНТАЖУ<br>ИНСТРУКЦИЯ ПО ЭКСПЛУАТАЦИИ |
| <b>RO</b> | INSTRUCȚIUNI DE INSTALARE<br>INSTRUCȚIUNI DE UTILIZARE | <b>IT</b> | ISTRUZIONI DI MONTAGGIO<br>MANUALE DI ISTRUZIONI    |
| <b>FR</b> | NOTICE DE MONTAGE<br>MANUEL INSTRUCTIONS               | <b>SK</b> | MONTÁŽNY NÁVOD<br>NÁVOD NA POUŽITIE                 |
| <b>HU</b> | KÖZGYŰLÉS UTASÍTÁSOK<br>KEZELÉSI UTASÍTÁS              | <b>CZ</b> | MONTÁŽNÍ NÁVOD<br>NÁVOD K POUŽITÍ                   |
| <b>SI</b> | NAVODILA ZA MONTAŽO<br>NAVODILA ZA UPORABO             | <b>PT</b> | INSTRUÇÕES DE MONTAGEM<br>MANUAL DO USUÁRIO         |
| <b>ES</b> | INSTRUCCIONES DE MONTAJE<br>MANUAL DEL USUARIO         | <b>HR</b> | UPUTE ZA MONTAŽU<br>UPUTE ZA UPOTREBU               |

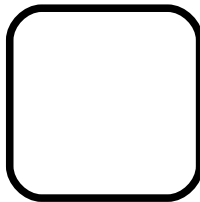
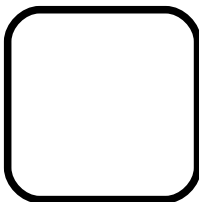

0089

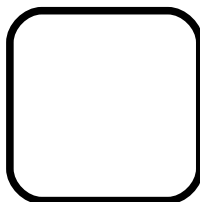
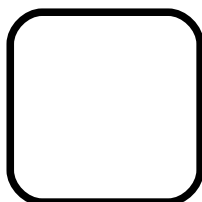
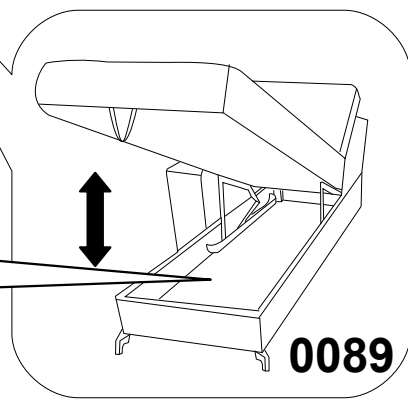
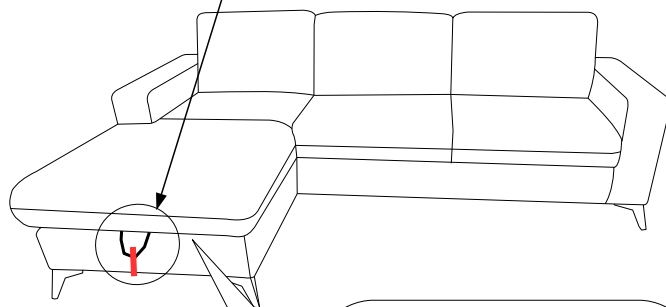
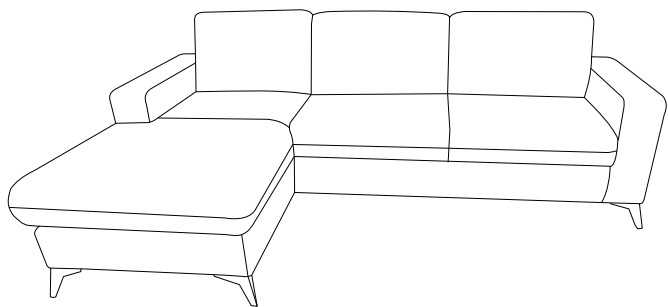
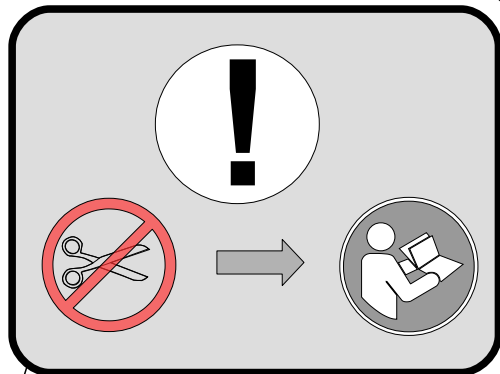

0019

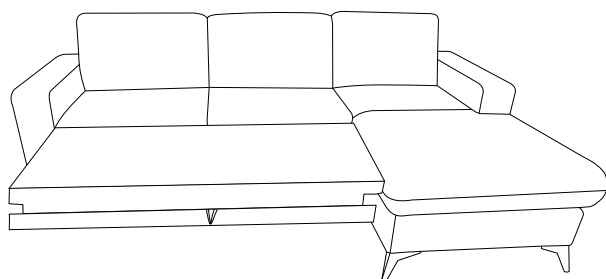
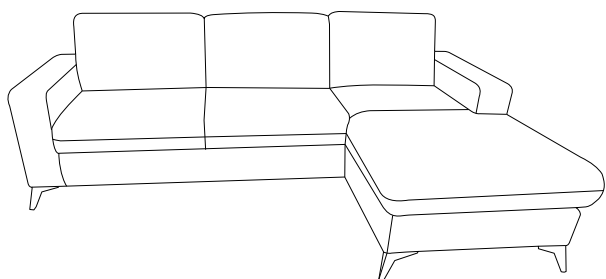



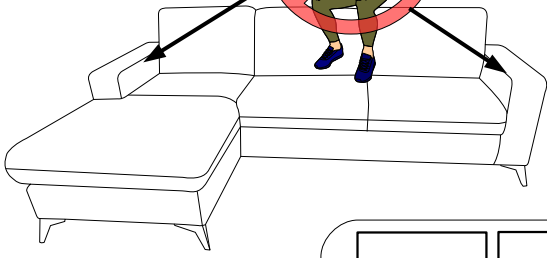
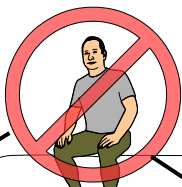

0019

L

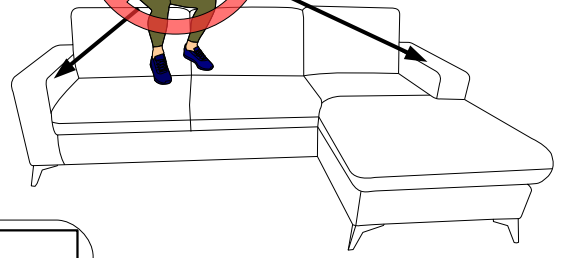



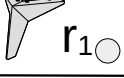

R

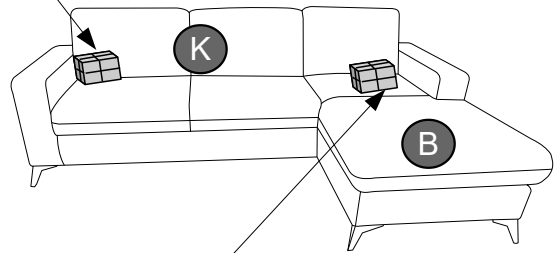
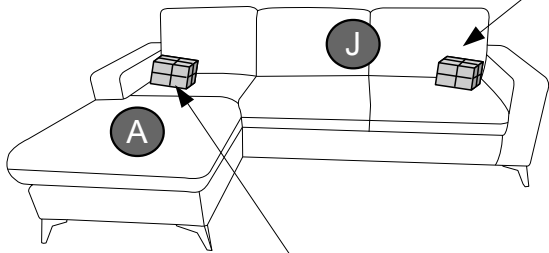





<b>Z</b> H-120  X1	<b>r</b> H-120  X2	<b>W</b> M6*25  X8	<b>i</b> L4  X1	[mm]
---	---	---	---	------

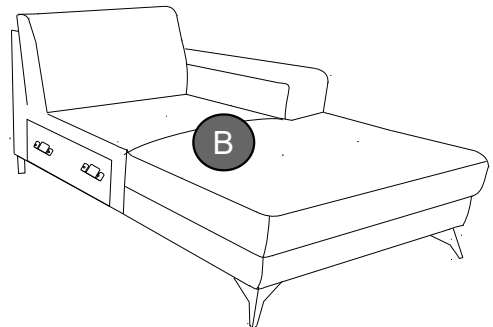
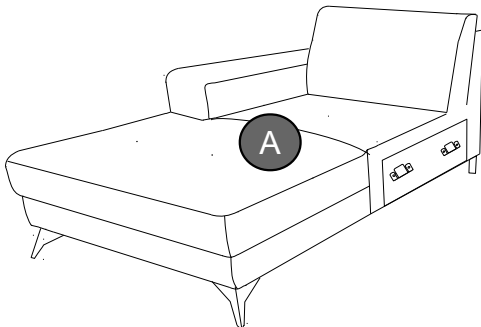
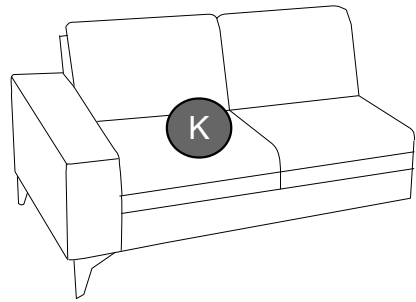
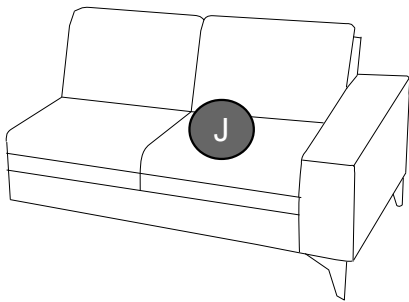

<b>X</b> H-120  X1	<b>Z</b> H-120  X1	<b>r</b> H-120  X4	<b>W</b> M6*25  X16	<b>i</b> L4  X1
--	--	--	---	---



<b>X</b> H-120  X1	<b>Z</b> H-120  X2	<b>r</b> H-120  X6	<b>W</b> M6*25  X24	<b>i</b> L4  X1
--	--	--	---	---

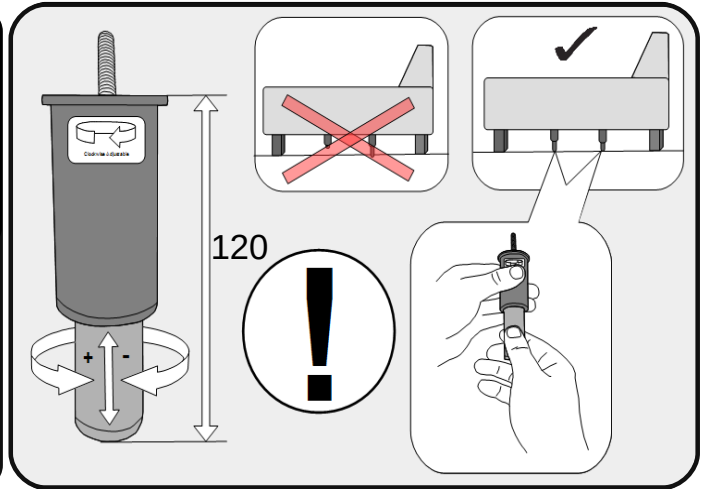
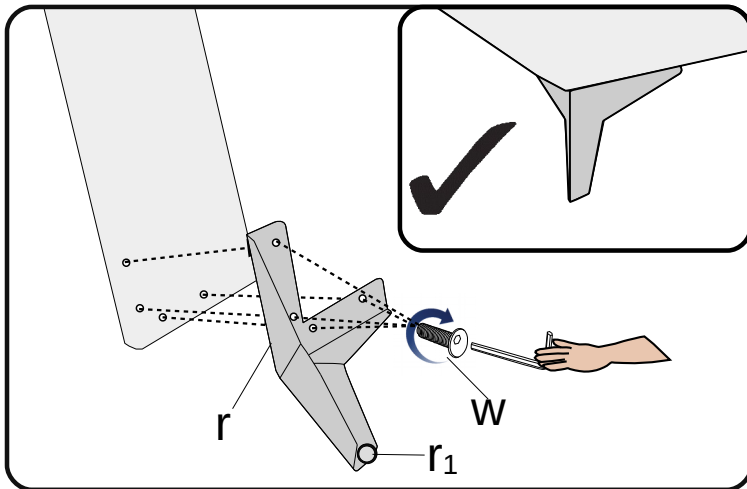
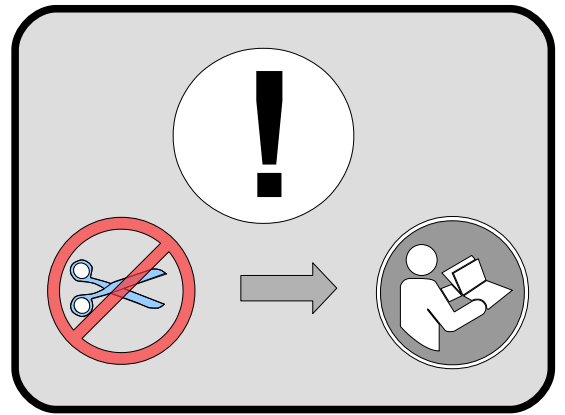
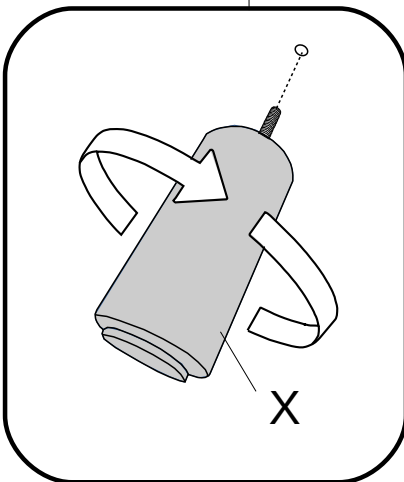
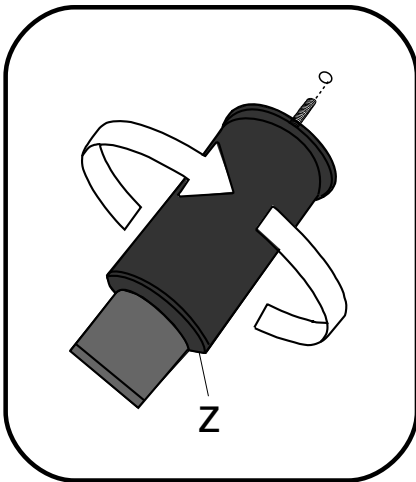
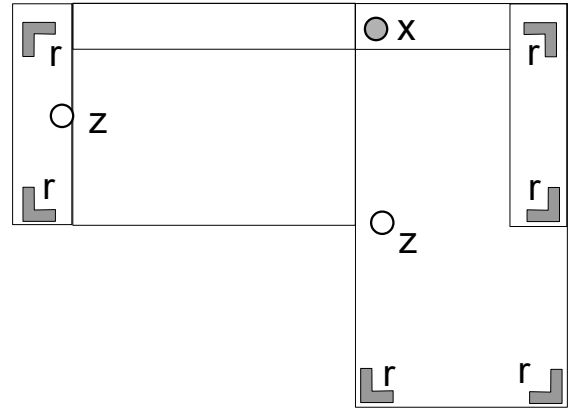
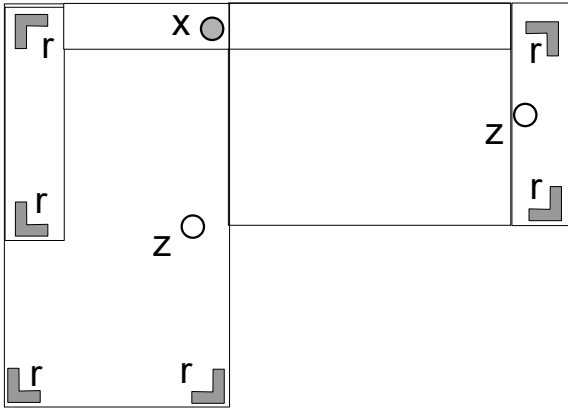
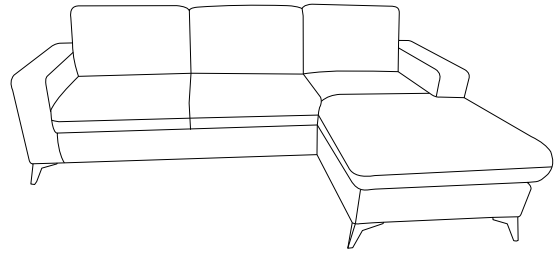
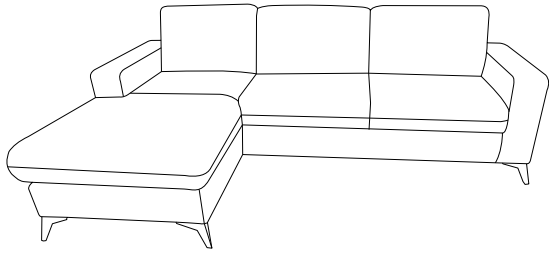

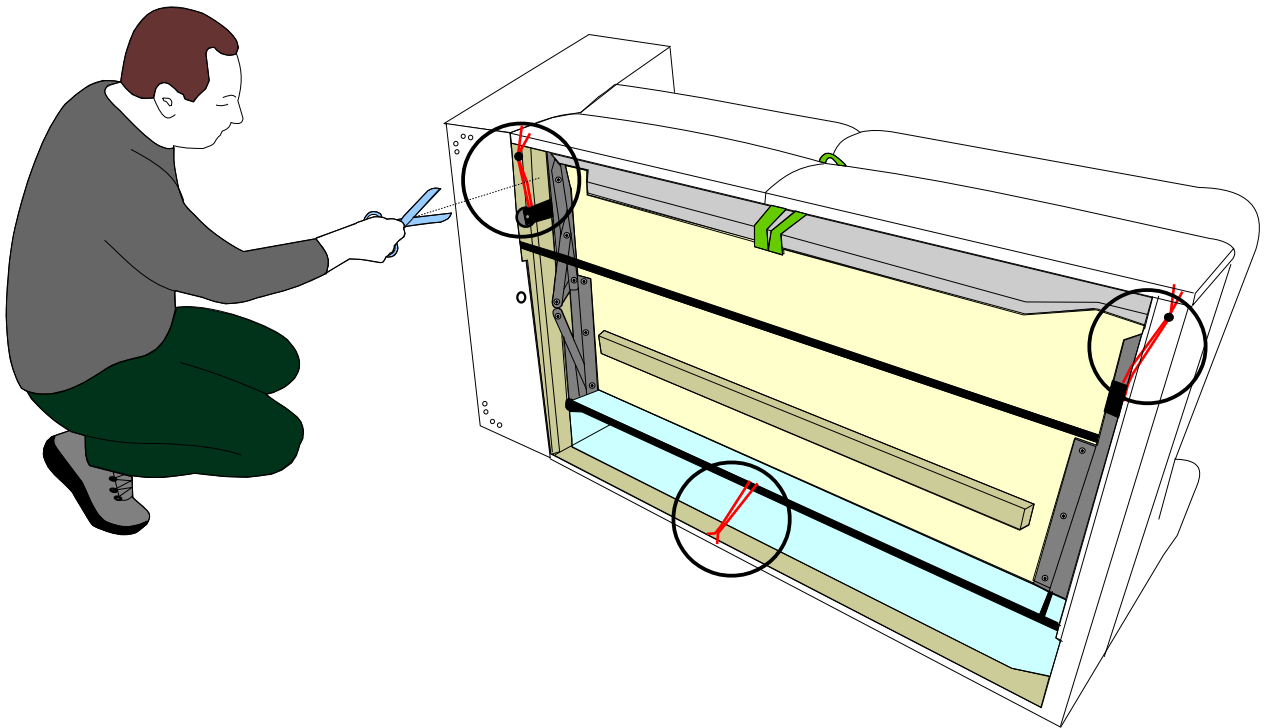
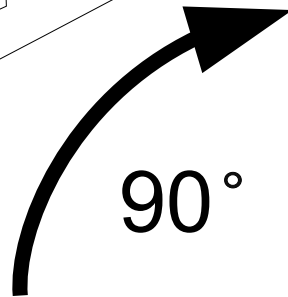
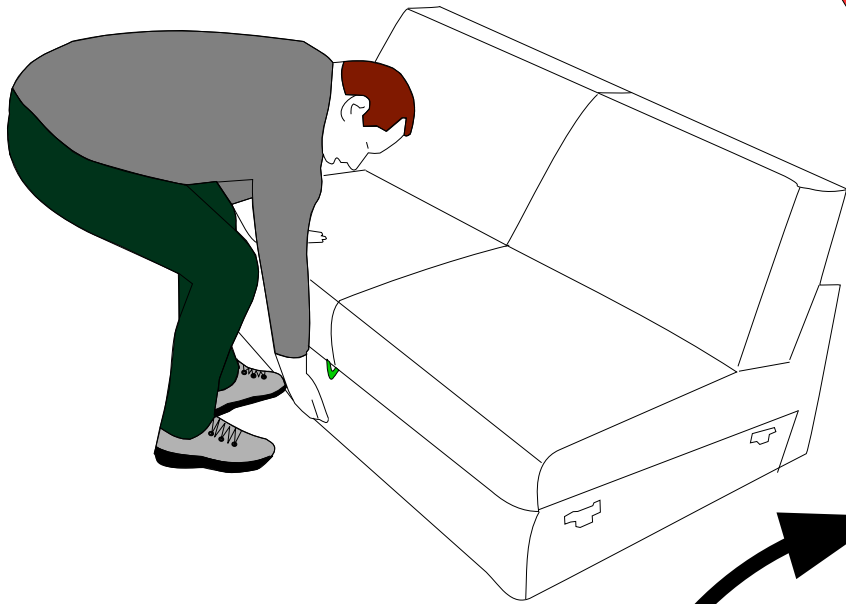

0019

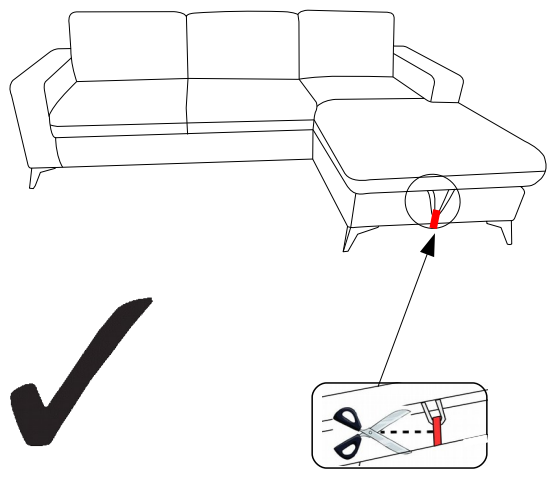
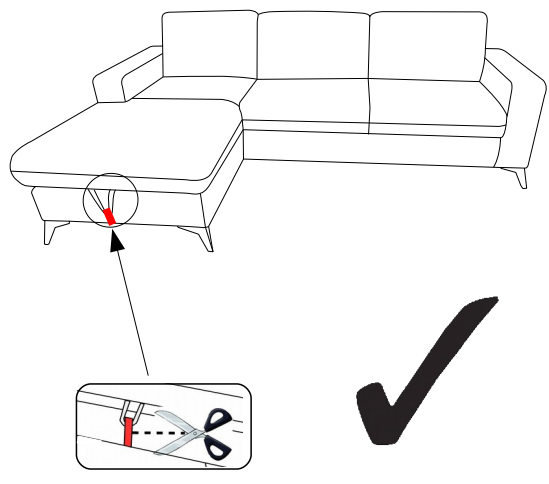
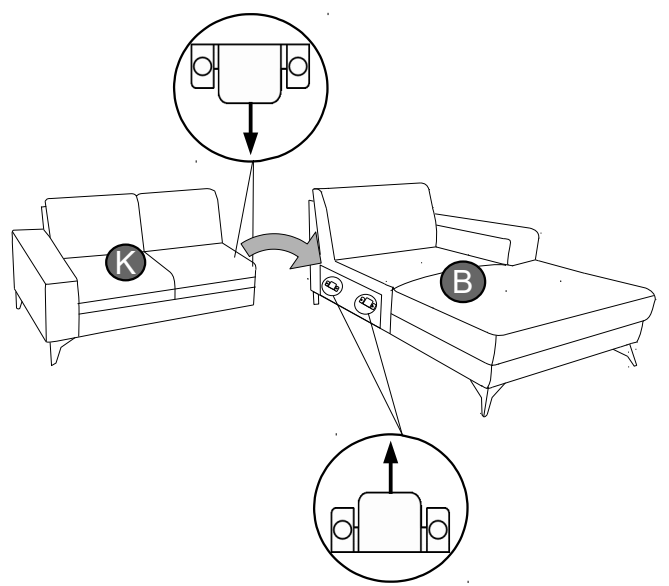
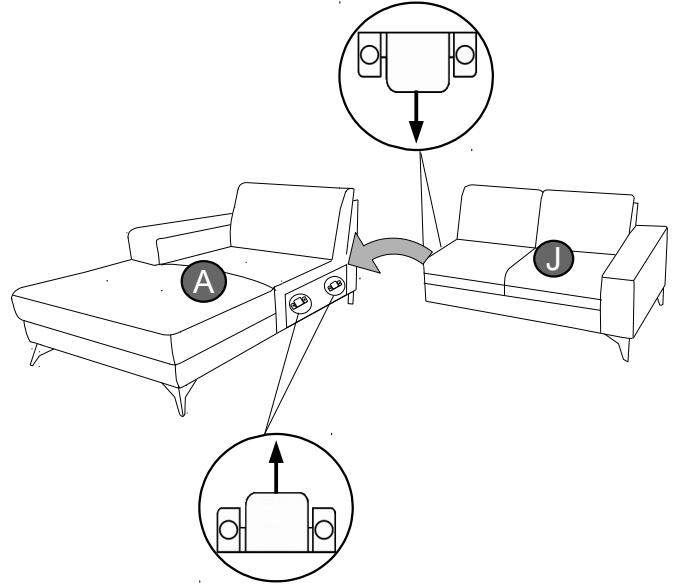
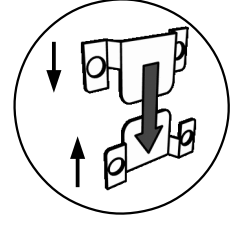
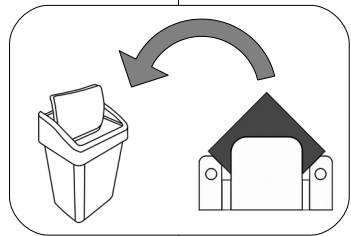
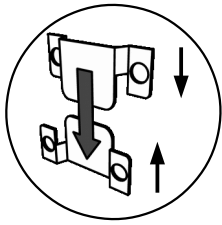

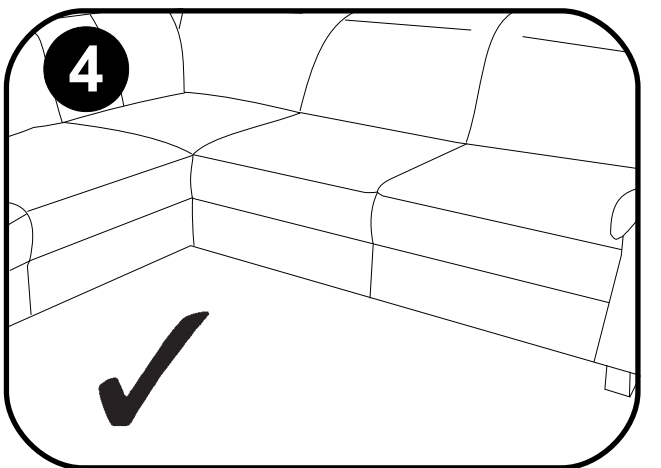
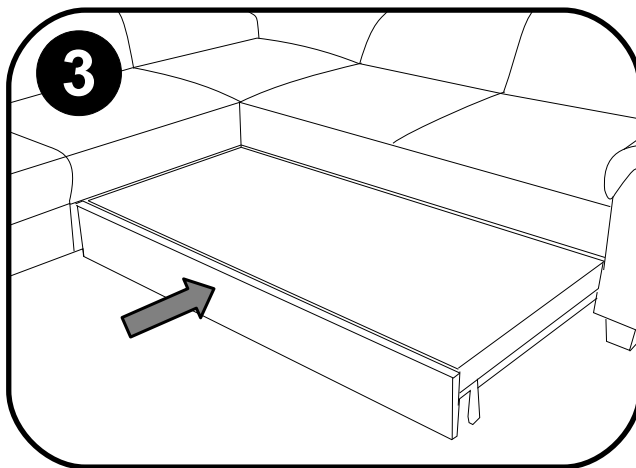
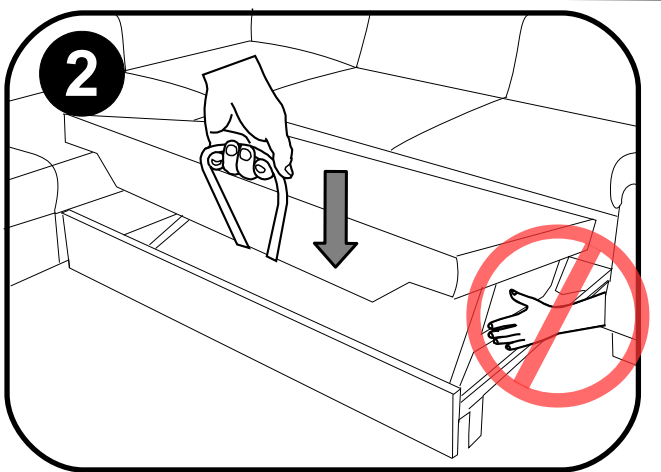
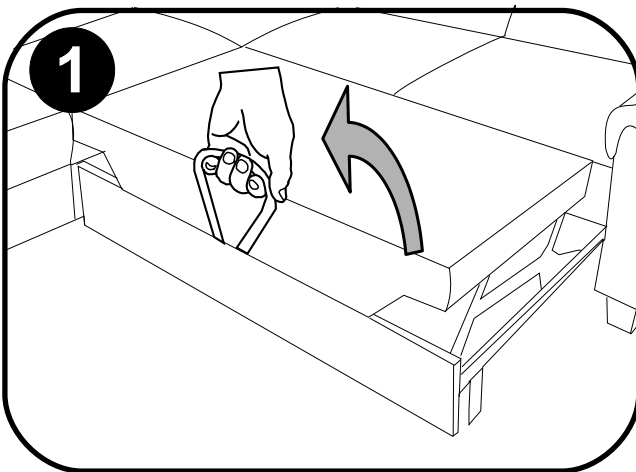
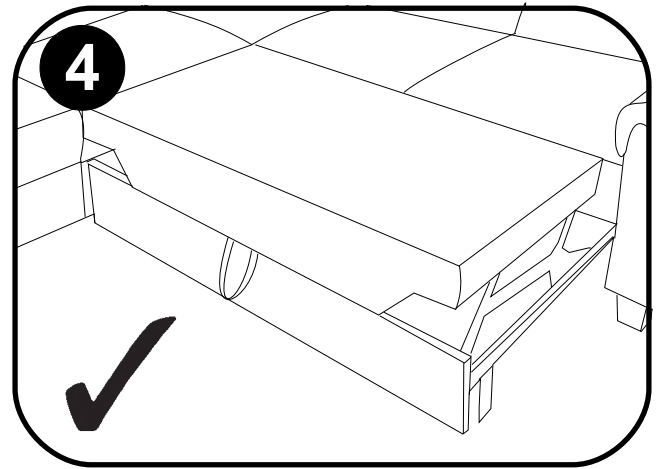
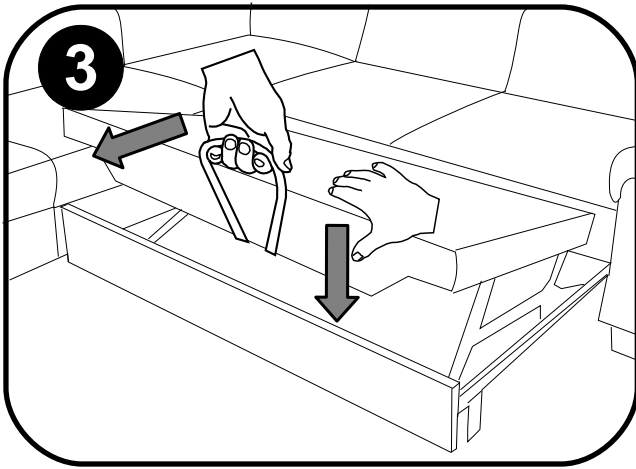
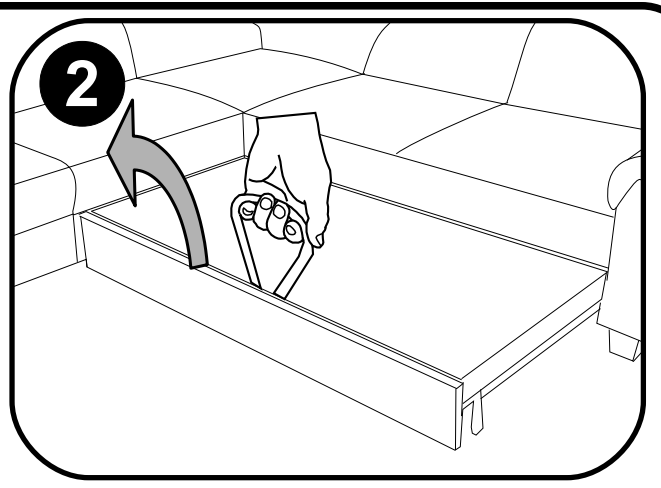
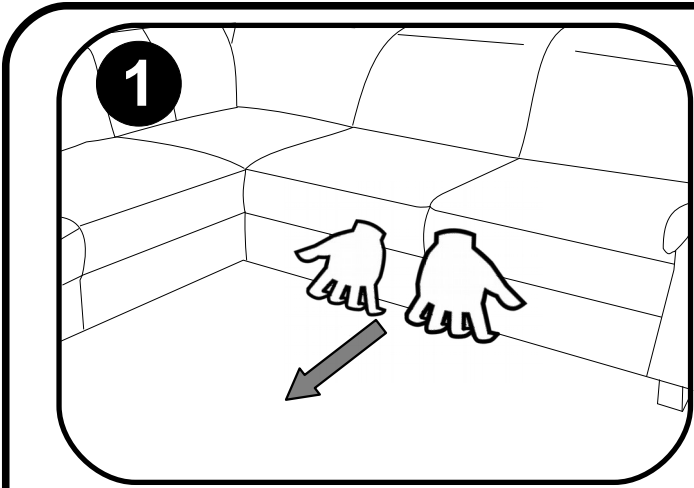
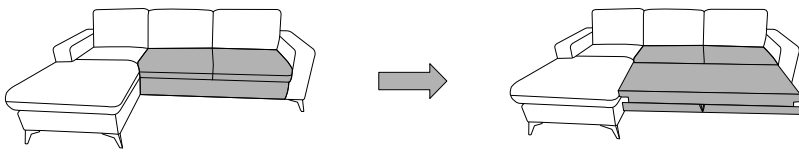

Service · Dienstverlening · Serwis · Servis · Сервисная служба · Serviciu · Services · Servizio  
 ·Servisný list · Szolgáltatás · Servisní list

Name · Naam · Nazwa · İsim · Название · Nume · Nome · Název · Názov ·  
 Název · Neve

**LOLLAND**

Typ · Type · Tip · Тип · Tipo · Típus

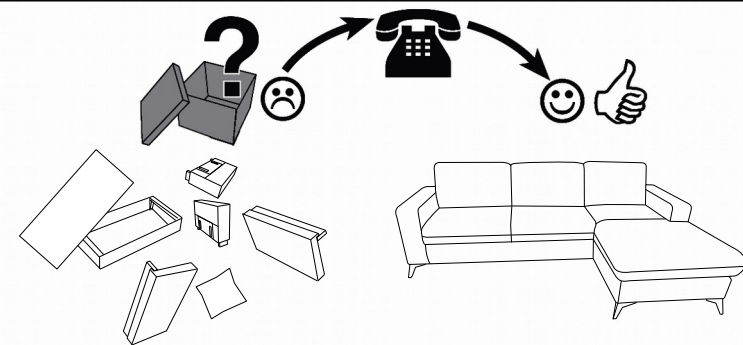
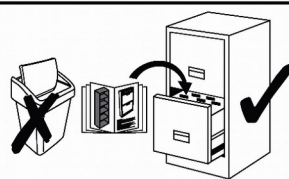

**L**

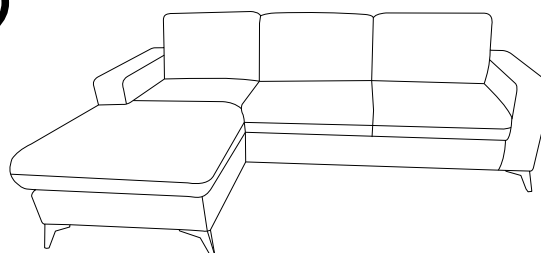

**R**

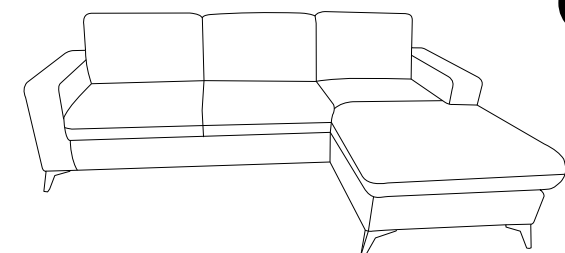

<b>X</b> H-120 	<b>Z</b> H-120 	<b>r</b> H-120 	<b>W</b> M6*25 	<b>i</b> L4 [mm] 
--------------------	--------------------	--------------------	--------------------	----------------------

