

Montageanleitung	D	Руководство по монтажу	RUS
Installation Instructions	GB	Instrucțiuni de instalare	RO
Instructions d'installation	F	Návod na montáž	SK
Montagehandleiding	NL	Návod k instalaci	CZ
Istruzioni di montaggio	I	Szerelési útmutató	H
Instrukcja montażu	PL	Kurulum Talimatları	TR

12.2018

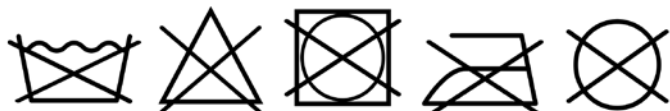
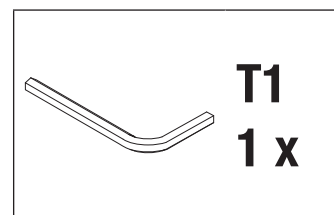
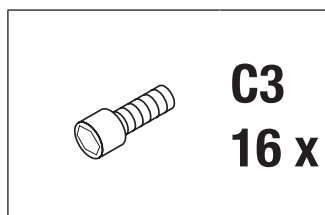
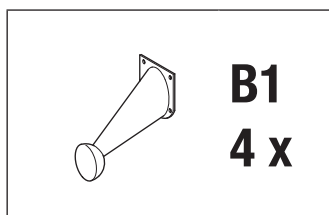
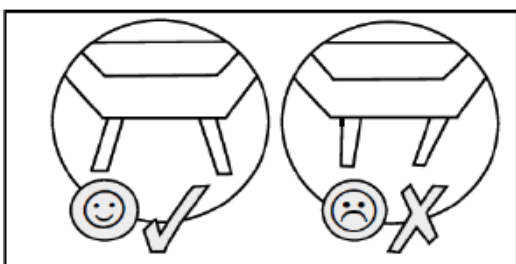
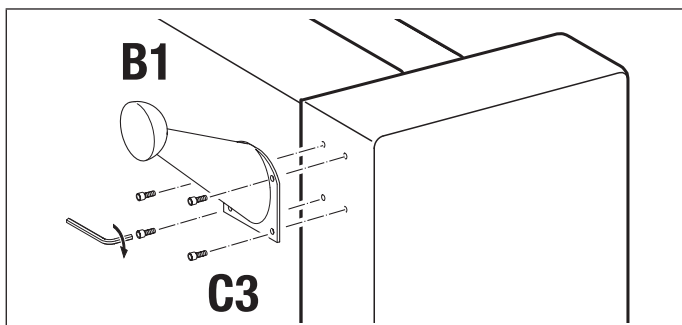
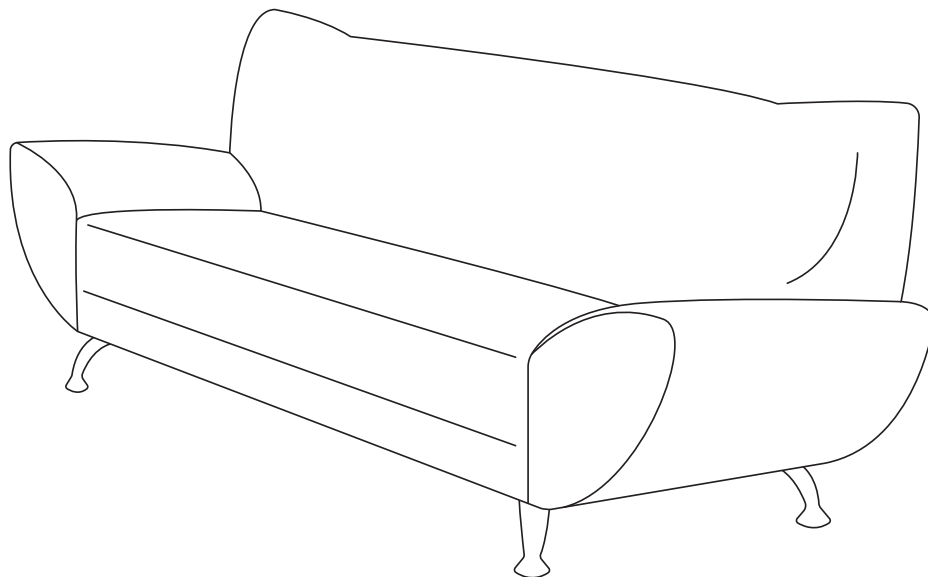

**Service • Assistenza • Dienstverlening • Serwis •
Servis • Szervis • Сервисная служба**

Name • Nom • Nome • Naam • Nazwa • Jméno • Názov • Nev • Denumire • Isim • Название	Saltare	
Тур • Type • Tip • Tipus • Tipo • Тип	3er Sofa	

