

# Allie 3S Sofabed

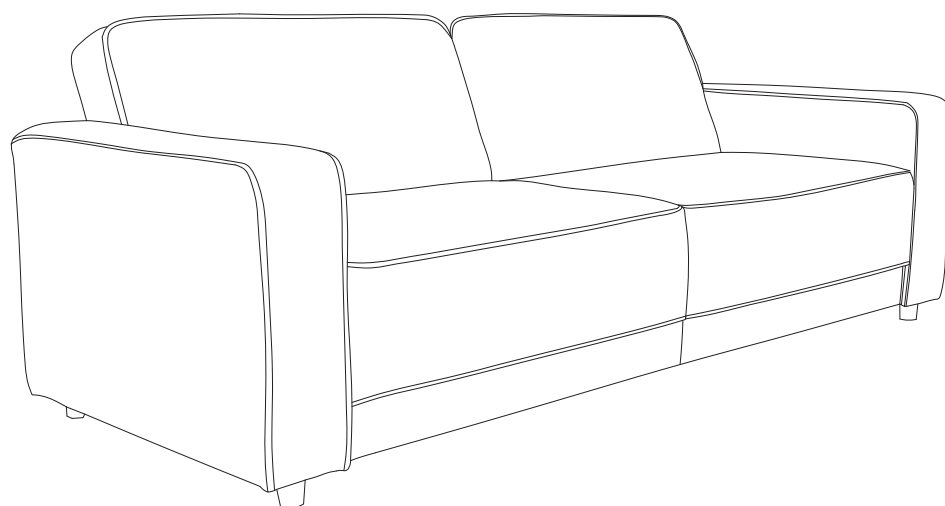

**(D)** Montageanleitung

**(FR)** Notice de montage

**(NL)** Handleiding voor de montage

**(CZ)** Montážní návod

**(HU)** Szerelési útmutató

**(TR)** Montaj talimatı

**(GB)** Assembly instructions

**(IT)** Istruzioni di montaggio

**(PL)** Instrukcja montażu

**(SK)** Návod na montáž

**(RO)** Instrucțiuni de montaj

**(RU)** ИНСТРУКЦИЯ ПО МОНТАЖУ

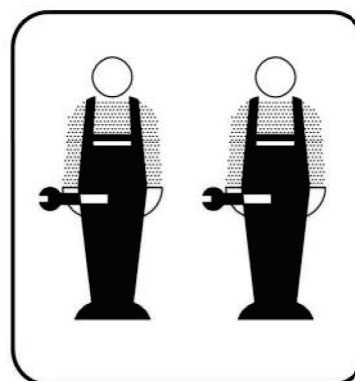
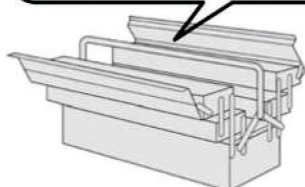
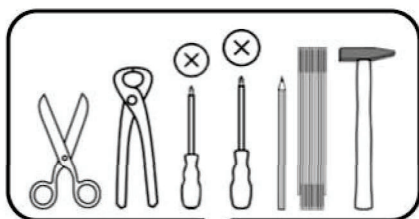

**Service • Assistenza • Dienstverlening • Serwis  
Servis • Szerviz • Сервисная служба**

Name • Nom • Nome • Naam Nazwa • Jméno • Názov • Név Denumire • Ísim • Название		
Nr. • No. • N° • Номер • Č • Sz		
Typ • Type • Tip • Típus • Тіпо Тип		

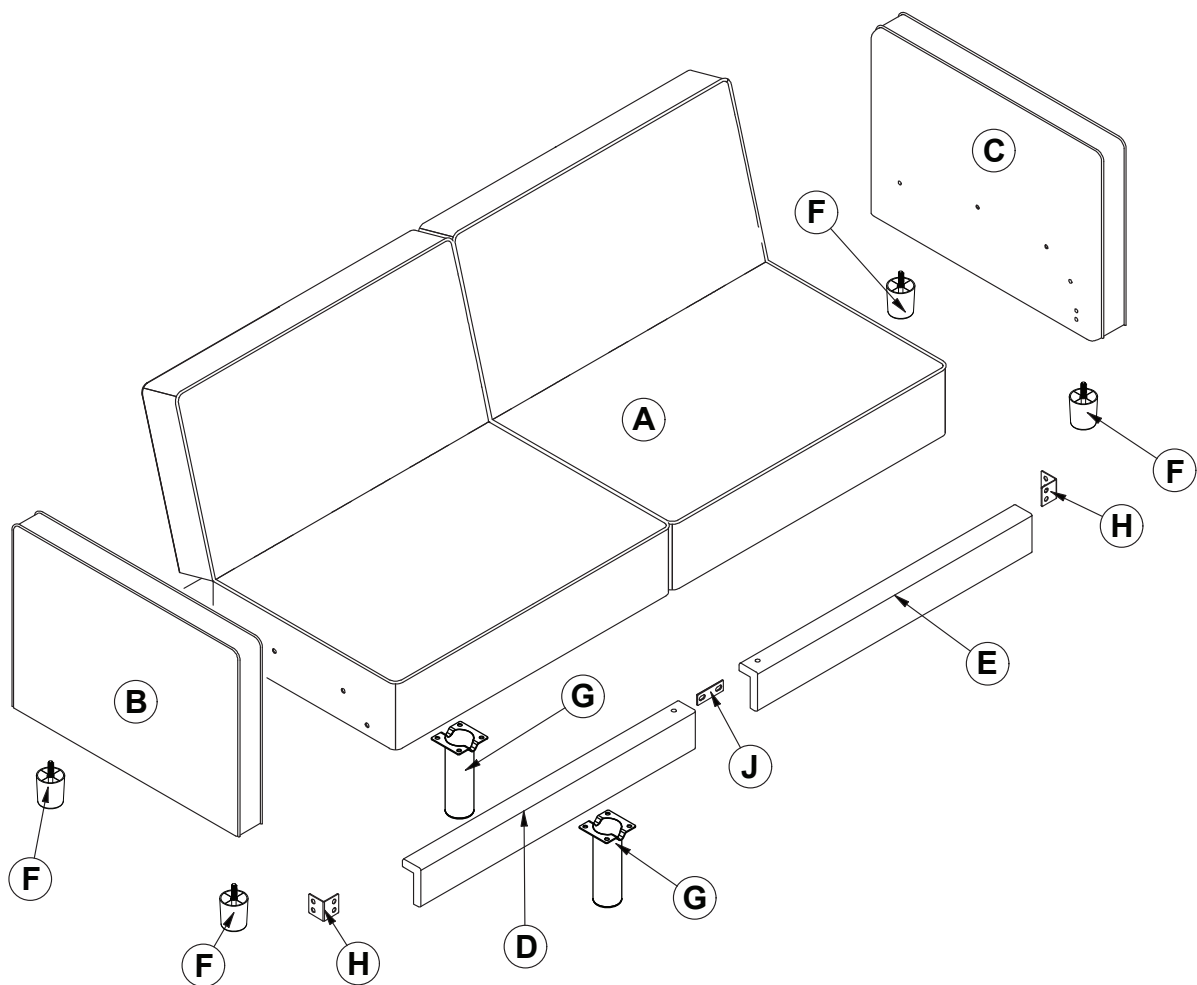

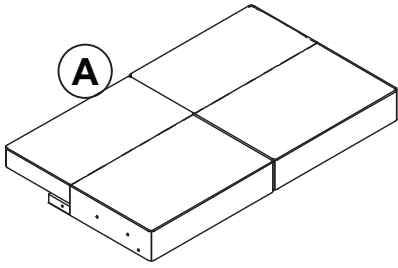

**X 1**

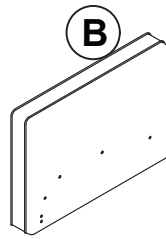

**X 1**

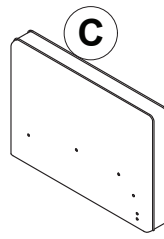

**X 1**

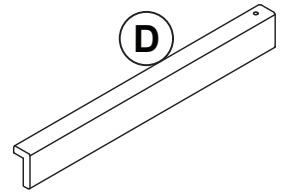

**X 1**

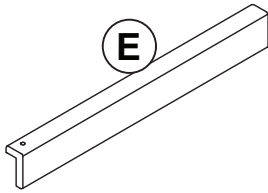

**X 1**

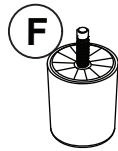

**X 4**

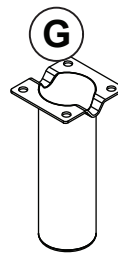

**X 2**

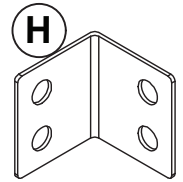

**X 2**

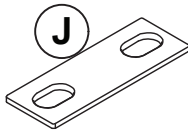

**X 1**

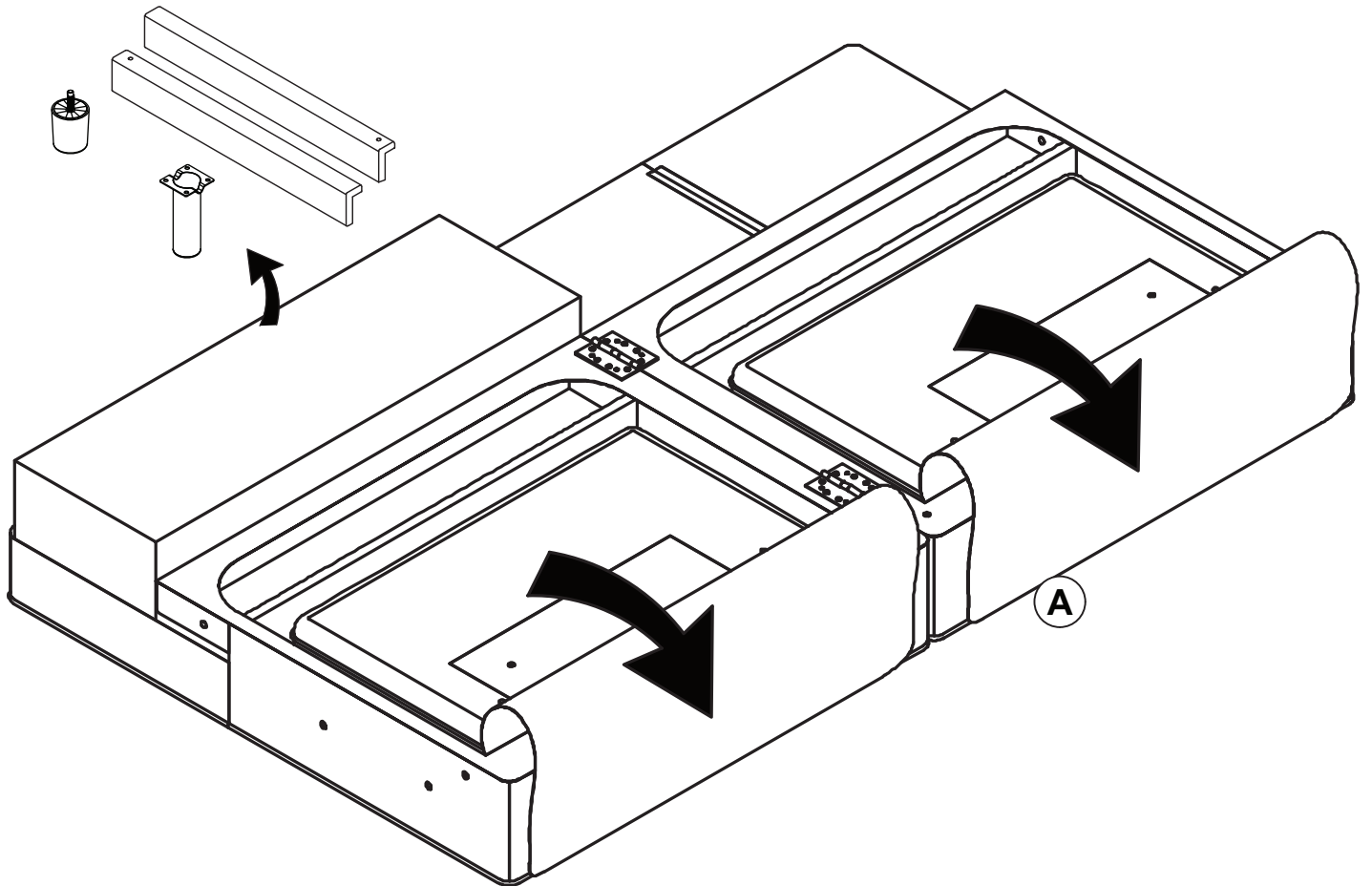

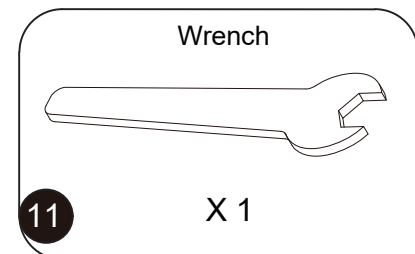
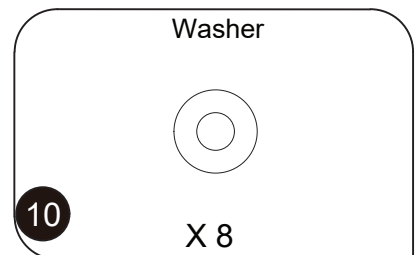
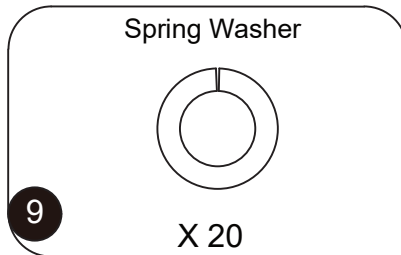
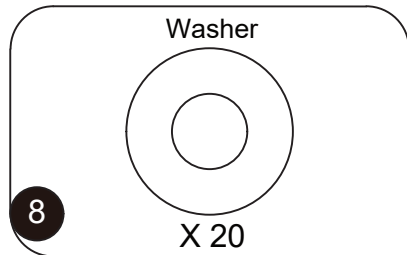
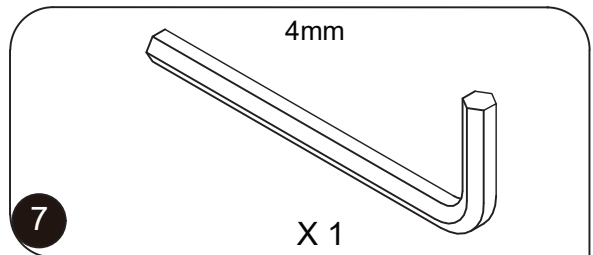
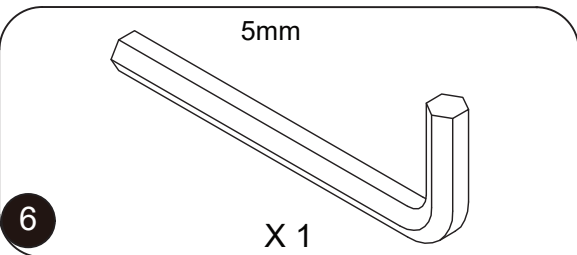
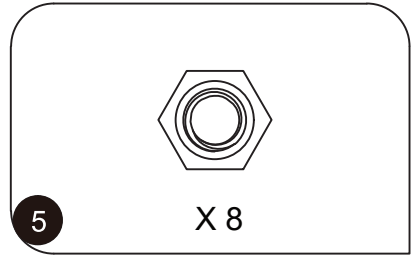
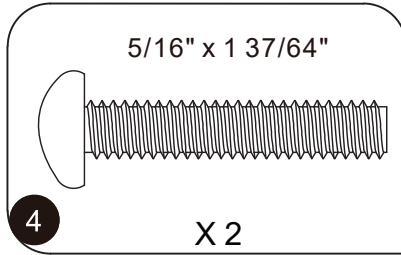
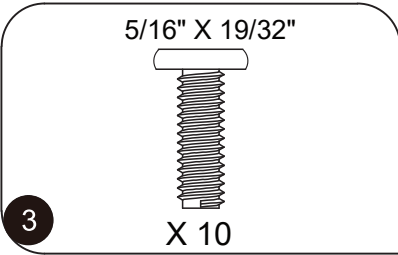
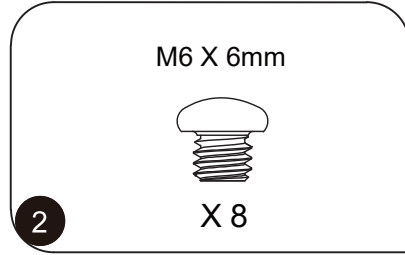
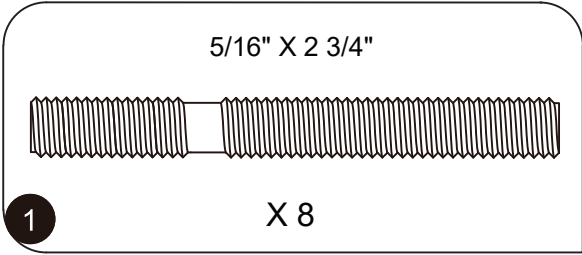

02

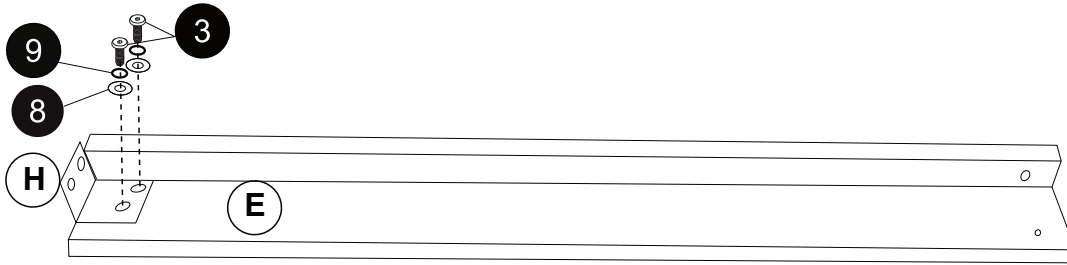
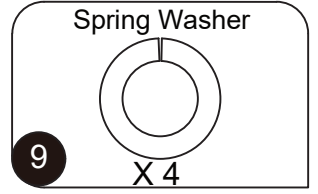
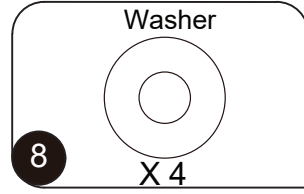
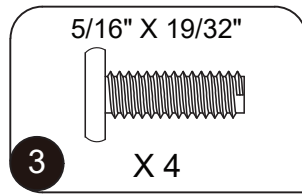

03

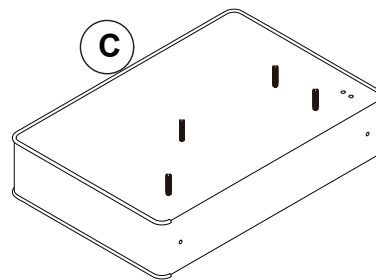
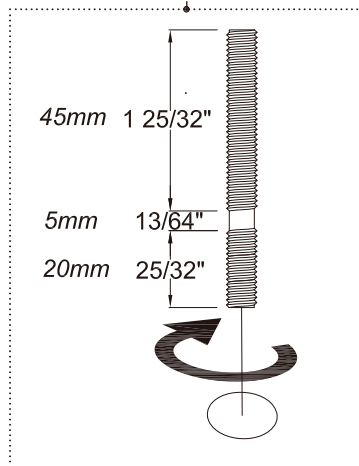
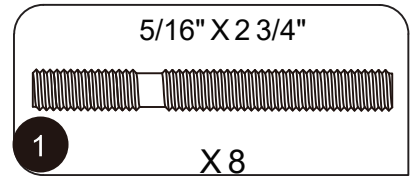
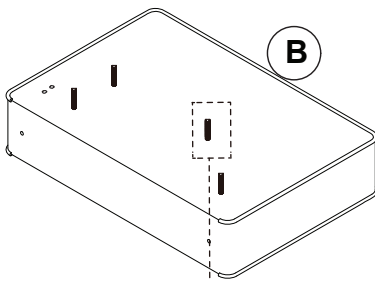

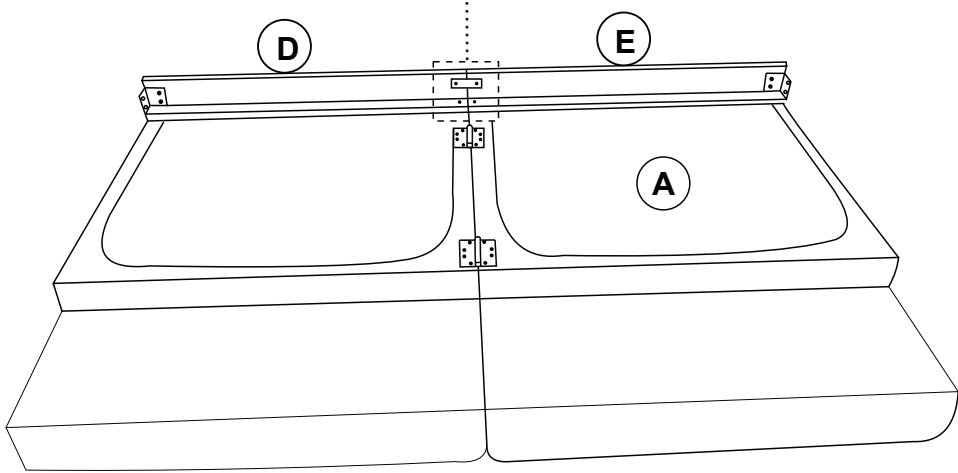
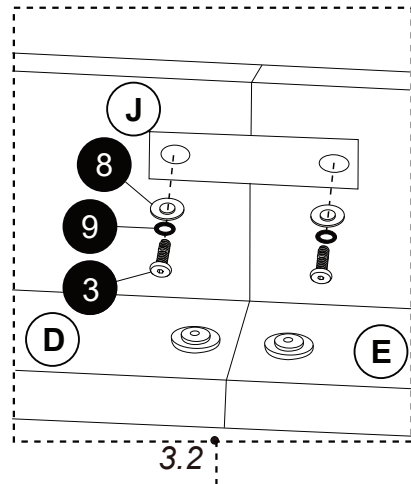
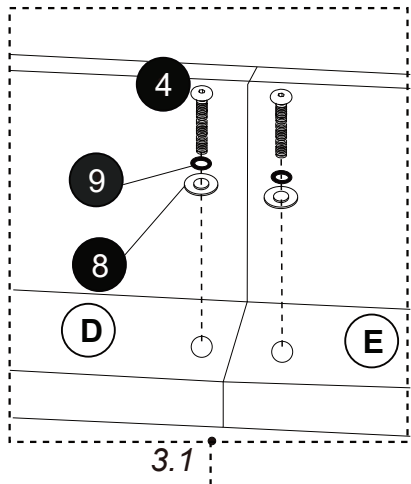
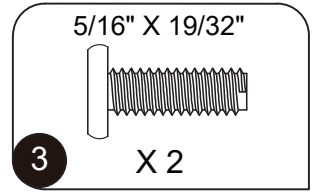
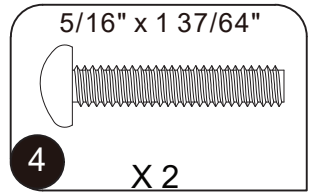
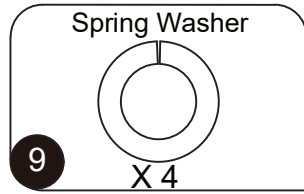
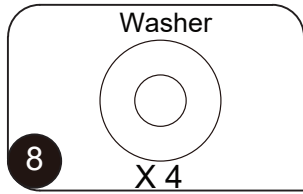

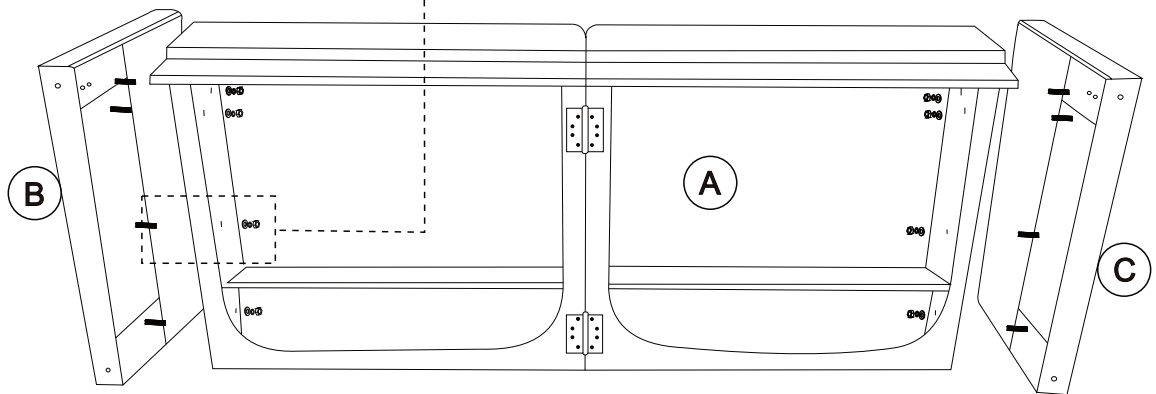
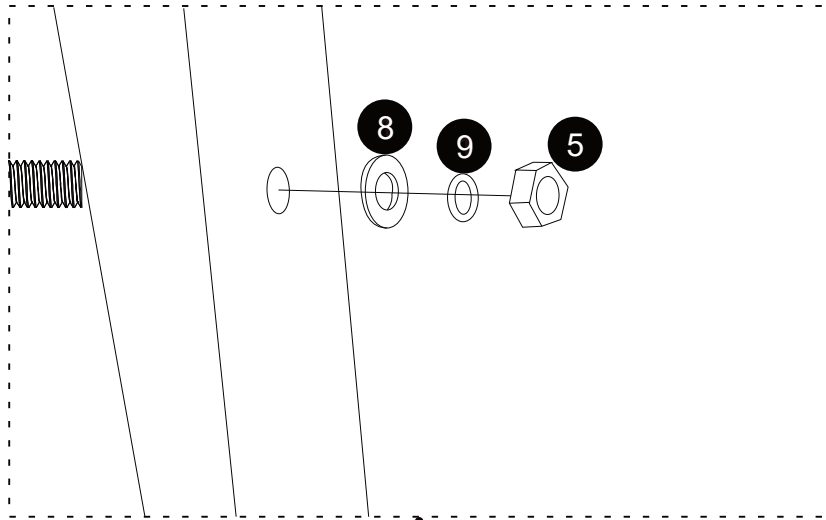
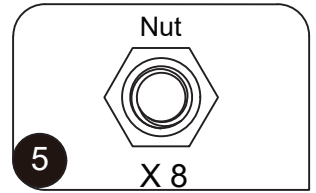
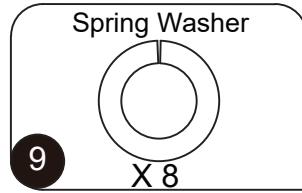
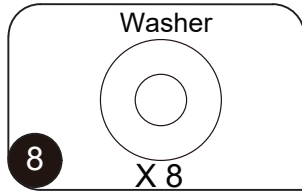



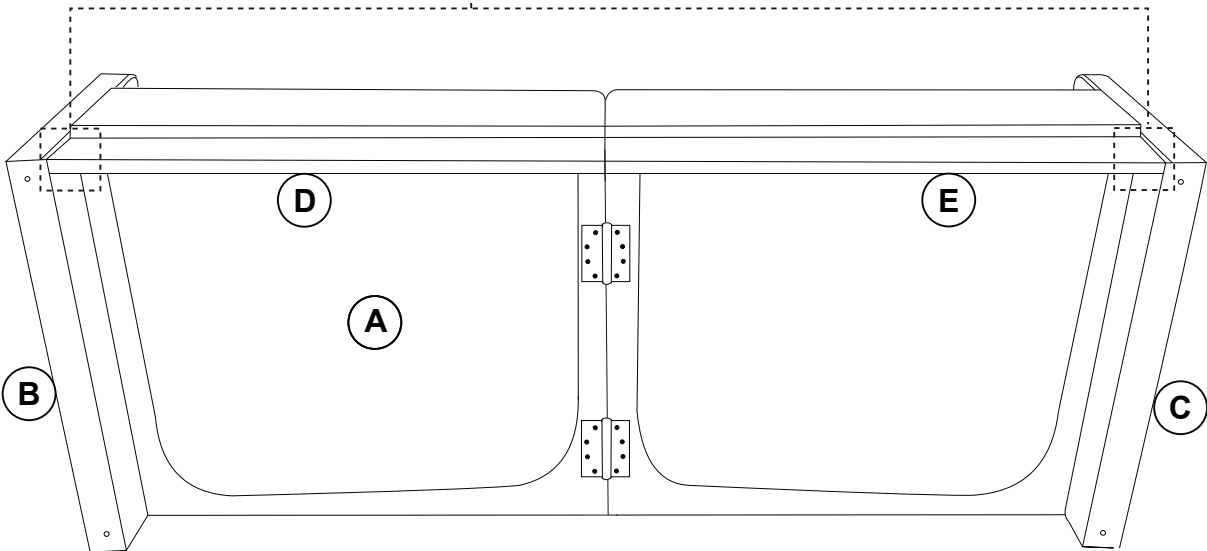
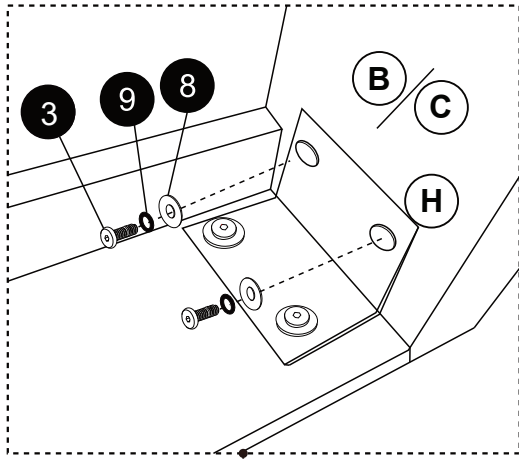
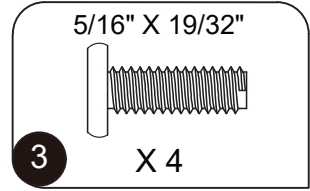
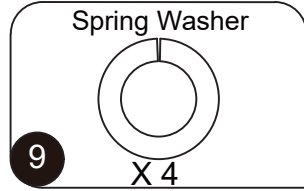
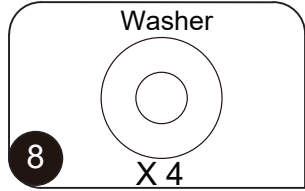

07

M6 X 6mm



2

X 8

Washer



10

X 8

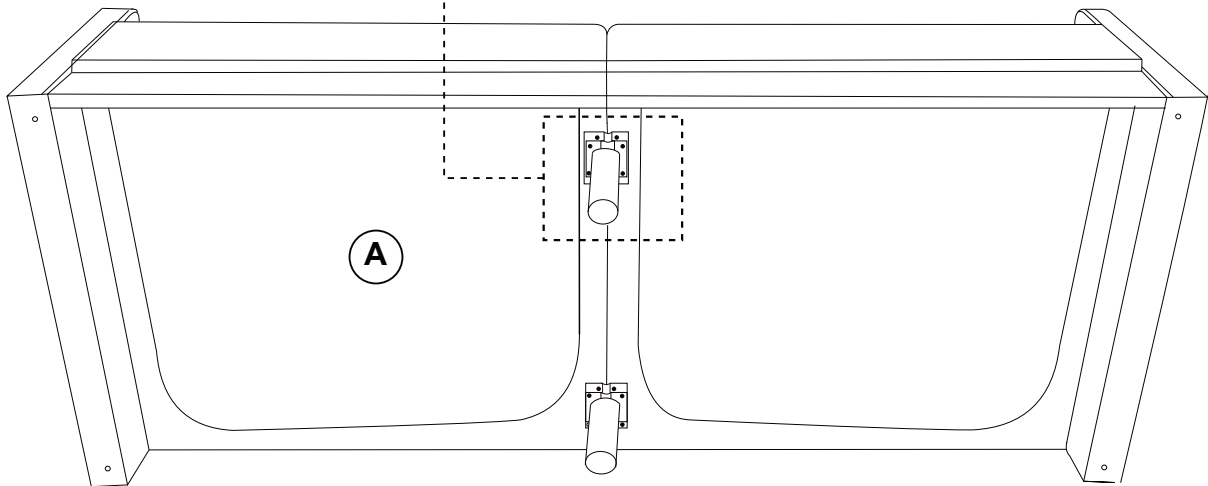
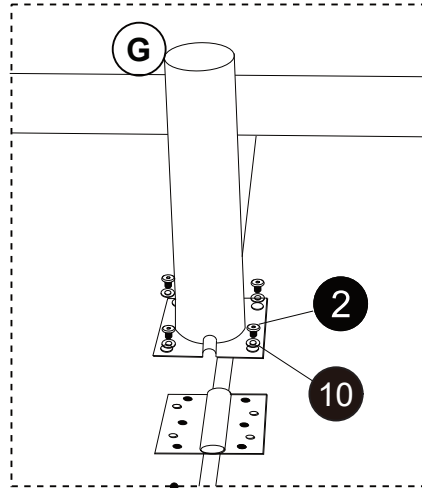

08

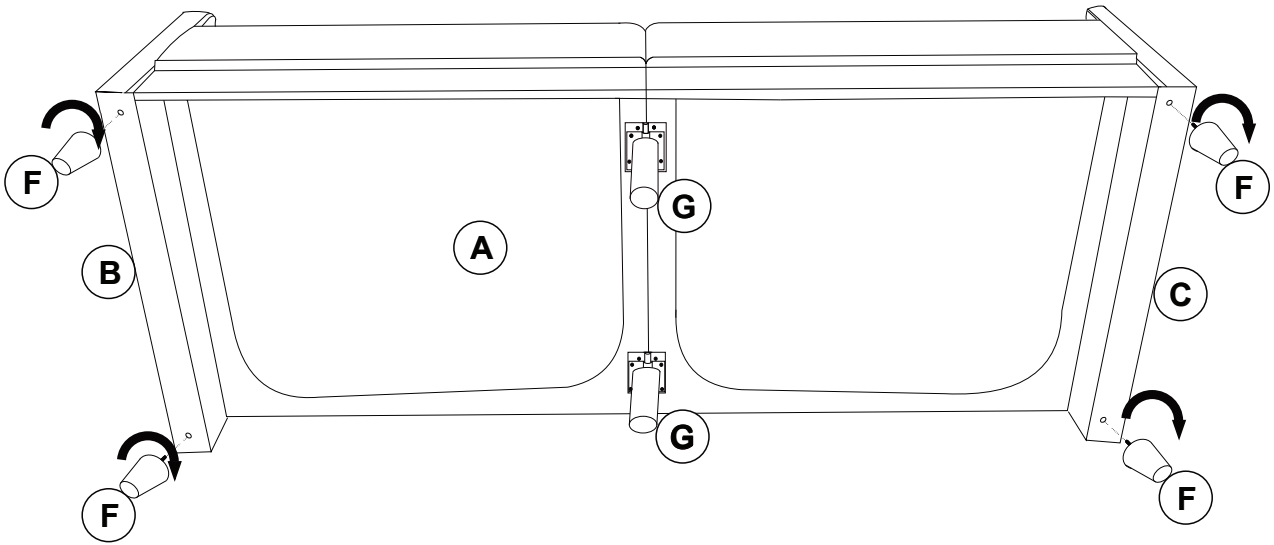
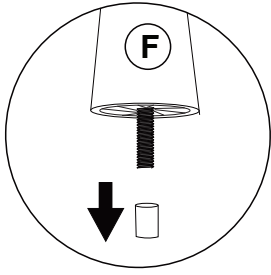

09

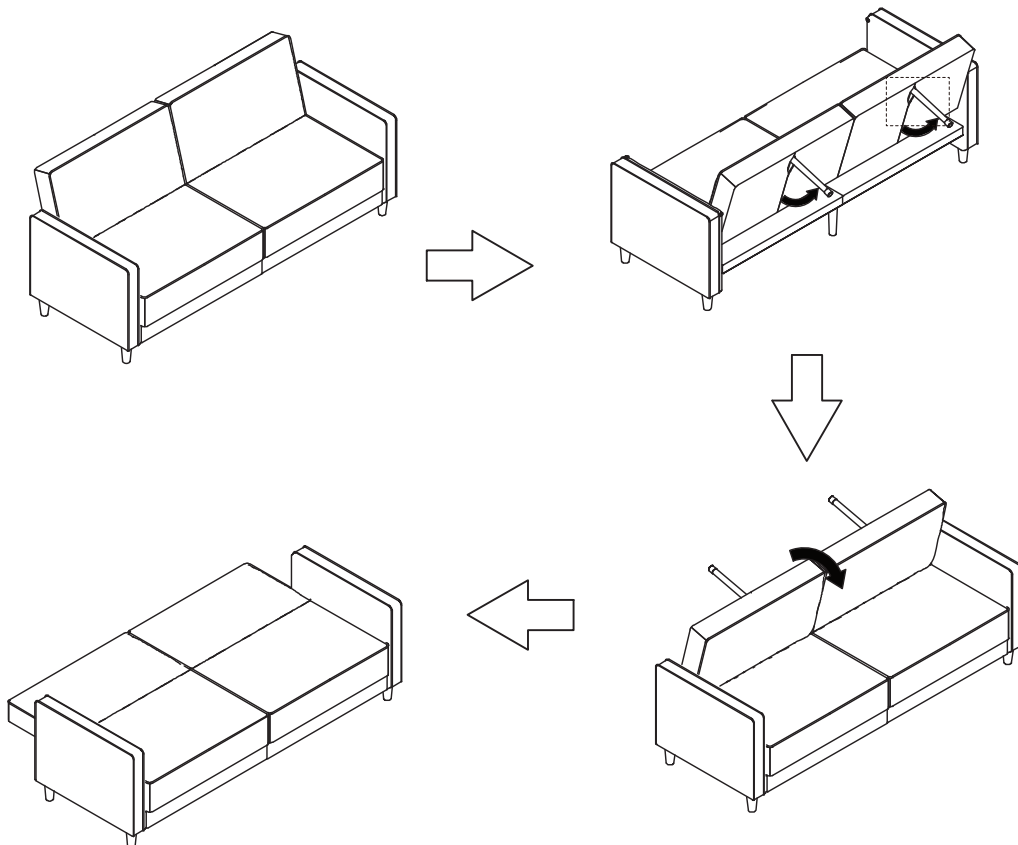

<b>1</b>	<b>D</b>	Ziehen Sie alle Schrauben sowie tragende Verbindungsteile nach ca. 5 Wochen nach, um eine dauerhafte Standsicherheit zu gewährleisten.
	<b>GB</b>	After approx. 5 weeks, tighten all screws and load-bearing connecting parts to ensure permanent stability.
	<b>FR</b>	Resserrez toutes les vis ainsi que les pièces de fixation au bout d'environ 5 semaines pour garantir une sécurité de fixation durable.
	<b>IT</b>	Ristringere tutte le viti e giunture dopo ca. 5 settimane, al fine di garantire una durevole solidità.
	<b>NL</b>	Draai alle schroeven en ook dragende verbindingstukken na ca. 5 weken nog eens vast, zodat een continue stabiliteit wordt gegarandeerd.
	<b>PL</b>	Prosimy po ok. 5 tygodniach dokręcić wszystkie śruby w elementach łączeniowych. Zagwarantuje to Państwu trwałość i stabilność połączeń.
	<b>CZ</b>	Dotáhněte všechny šrouby a nosné spojovací díly přibližně po 5 týdnech, aby se zaručila trvalá stabilita.
	<b>SK</b>	Po cca 4 týždňoch dotiahnite skrutky, aby bola zaručená ich trvalá stabilita.
	<b>HU</b>	Húzza utána – kb. 5 hét múlva – az összes csavart és a teherhordó összekötő-alkatrészeket a biztonság érdekében.
	<b>RO</b>	Pentru a asigura o stabilitate de durată, strângeți după cca. 5 săptămâni toate șuruburile, precum și toate elementele portante de legătură.
	<b>TR</b>	Tüm vida ve taşıyıcı bağlantı parçalarını kalıcı bir duruş güvenliğini sağlamak için yaklaşık 5 hafta sonra tekrar sıkınız.
	<b>RU</b>	Подкрутите все болты, а также несущие соединительные детали прибл. через 5 недель для обеспечения устойчивости в течение длительного времени.
<b>2</b>	<b>D</b>	Bitte nur mit einem Staubtuch oder leicht feuchtem Lappen reinigen. Keine scheuernden Putzmittel verwenden.
	<b>GB</b>	Please only clean with a duster or a damp cloth. Do not use any abrasive cleaners.
	<b>FR</b>	Veillez nettoyer uniquement avec un chiffon à poussière ou un chiffon légèrement humide. Ne pas utiliser de détergent abrasif.
	<b>IT</b>	Si raccomanda di pulire solo con un panno per la polvere o uno strofinaccio umido. Non utilizzare detersivi abrasivi.
	<b>NL</b>	Reinig alleen met een stofdoek of een lichtjes vochtige doek. Gebruik geen schurende poetsmiddelen.
	<b>PL</b>	Czyszczenie należy wykonać wyłącznie za pomocą ściereczki lub lekko nawilżonego ręcznika. Nie stosować środków czyszczących do szorowania.
	<b>CZ</b>	Čistěte prosím jen prachovkou nebo lehce navlhčeným hadrem. Nepoužívejte drhnuocí čisticí prostředky.
	<b>SK</b>	Na čistenie používajte len prachovku alebo zľahka navlhčenú utierku. Nepoužívajte žiadne drhnúce čistiace prostriedky.
	<b>HU</b>	Kérjük, csak portórlő kendővel vagy enyhén nedves ronggyal tisztítsa. Ne használjon dörzshatású tisztítószert.
	<b>RO</b>	Vă rugăm să utilizați la curățare exclusiv o cârpă de șters praful sau o cârpă ușor umezită. Nu utilizați substanțe de curățat abrazive.
	<b>TR</b>	Lütfen sadece bir toz bezıyla veya hafif nemli yumuşak bir bezle siliniz. Aşındırıcı temizlik malzemeleri kullanmayınız.
	<b>RU</b>	Очищайте от пыли тряпкой или слегка влажной ветошью. Не допускается применение чистящих средств, не предназначенных для ухода за мебелью.