

# SABA MOTOR

20190409

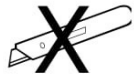

HDPE LDPE

100/120

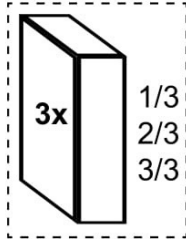
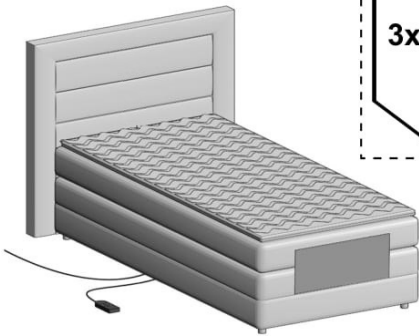

160/180

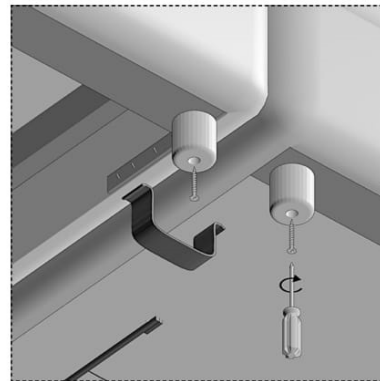
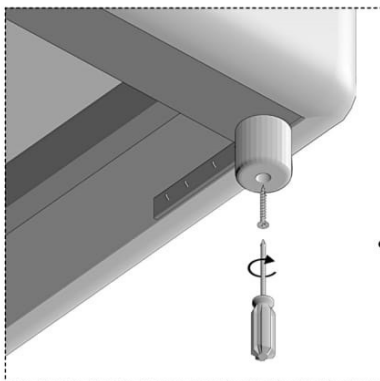
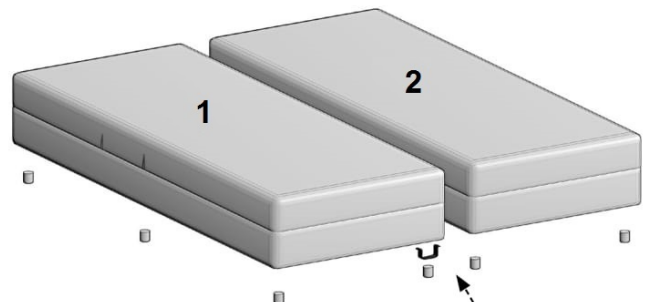
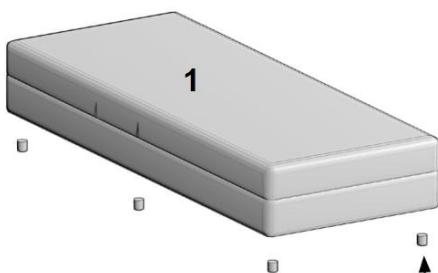
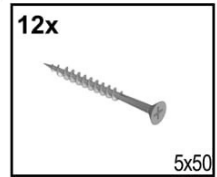
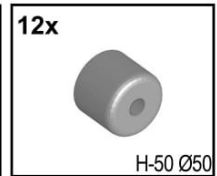
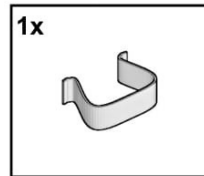
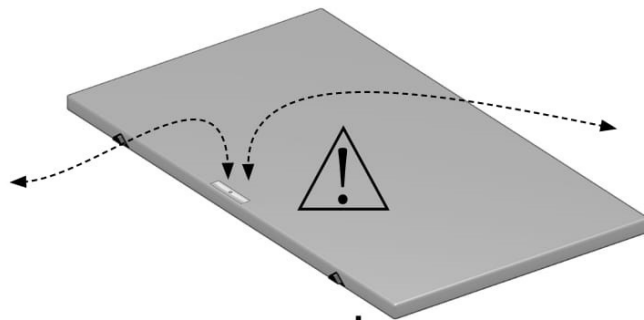
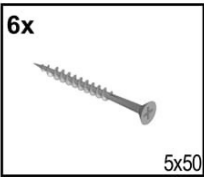
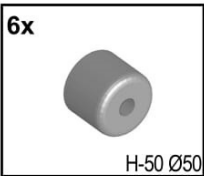
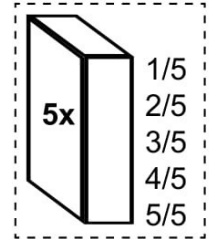
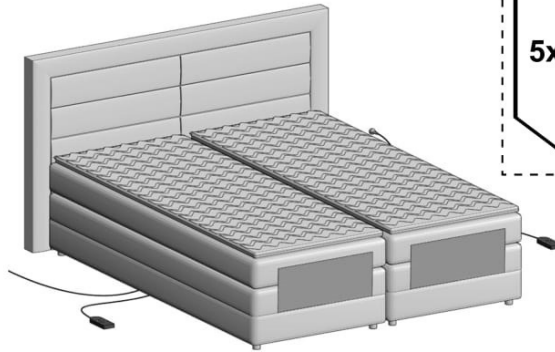

# SABA MOTOR

20190409

