



- (D) Montageanleitung
- (FR) Notice de montage
- (NL) Handleiding voor de montage
- (CZ) Montážní návod
- (HU) Szerelési útmutató
- (TR) Montaj talimatı
- (GB) Assembly instructions
- (IT) Istruzioni di montaggio
- (PL) Instrukcja montażu
- (SK) Návod na montáž
- (RO) Instrucțiuni de montaj
- (RU) ИНСТРУКЦИЯ ПО МОНТАЖУ

**Service • Assistenza • Dienstverlening • Serwis
Servis • Szerviz • Сервисная служба**



Name • Nom • Nome • Naam • Nazwa • Jméno • Názov • Név • Denumire • İsim • Название	
Nr. • No. • N° • Номер • Č • Sz Typ • Type • Tip • Típus • Tipo • Тип	



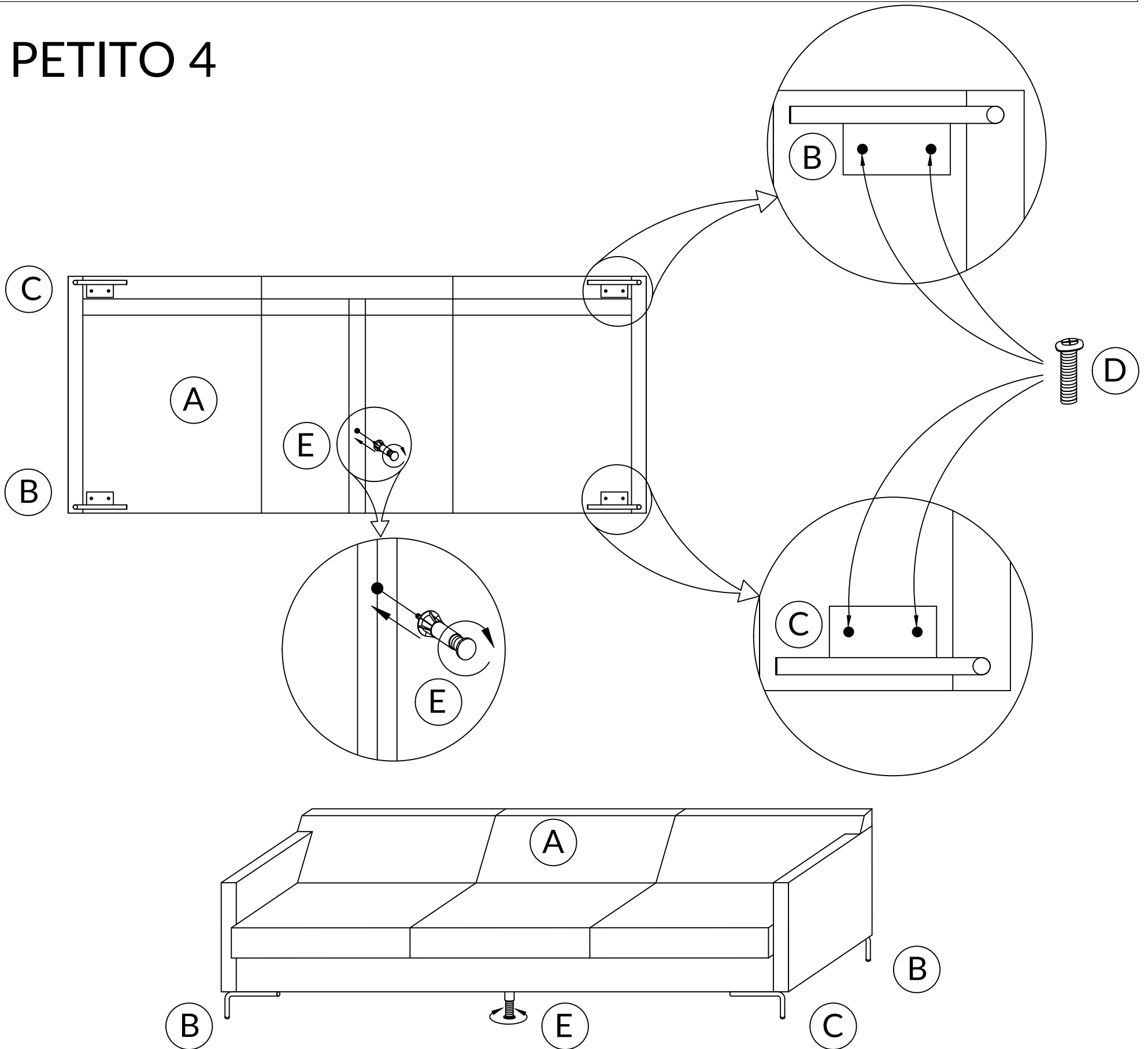

PETITO 4

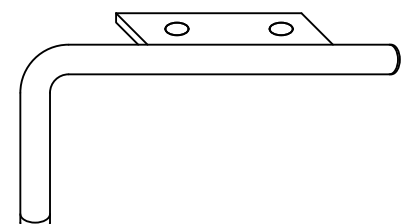
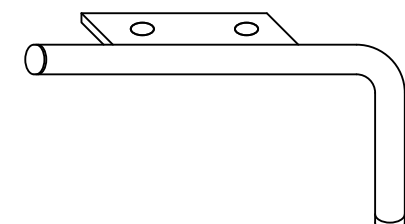
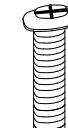

(B)  X 02	(C)  X 02	(D) M 8x30  X 08	(E)  X 01
