

2489440

489-001 / 10.05.2022

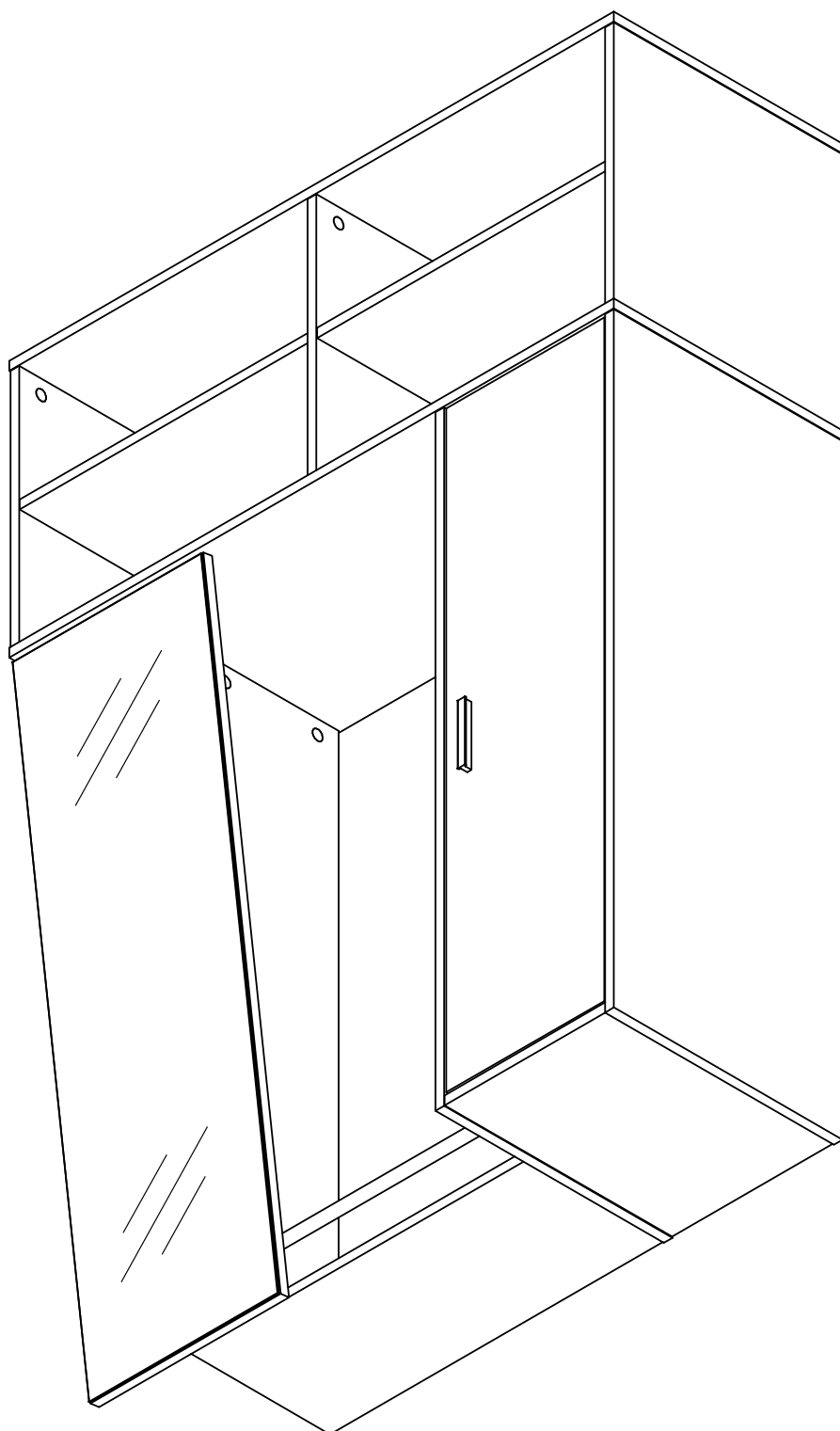



DE

Bitte die Montageanleitung vor Beginn sorgfältig studieren. Um eine ordnungsgemäße und mangelfreie Erstellung zu gewährleisten muss die Montage exakt in der gezeigten Reihenfolge ausgeführt werden. Wir empfehlen die Montage nur durch fachkundiges Personal.

GB

Please carefully read through the assembly instructions before starting. To ensure proper, fault-free construction, assembly is to be carried out exactly as shown in the sequence. We recommend having the assembly done only by qualified personnel.

FR

Lire scrupuleusement les instructions de montage avant de commencer le montage. Afin de garantir une construction conforme et irréprochable, le montage doit être effectué exactement dans l'ordre indiqué. Nous recommandons de ne faire effectuer le montage que par du personnel qualifié.

ES

Antes de empezar lea detenidamente las instrucciones de montaje. Para garantizar una construcción adecuada y sin defectos, el montaje deberá llevarse a cabo en el orden exacto que se indica. Le recomendamos que el montaje lo efectúe únicamente personal especializado.

CZ

Prostudujte, prosím, před začátkem práce pečlivě Montážní návod. Aby bylo zaručeno žádné a bezchybné sestavení, musí se montáž provést přesně v uvedeném pořadí. Doporučujeme, aby montáž prováděl v dané oblasti odborník.

SK

Pred započatím práce si prosíme starostlivo prečítať návod na montáž. Aby bolo možné zaručiť správne a bezchybné zostavenie, je nutné pri montáži dodržať presne vyznačený postup. Odporúčame nechať urobiť montáž odborníkovi.

HU

Kezddel a gondosan tanulmányozza a szerelési utasítást! Az abályszer és hibátlan elkészítés garantálása érdekében a szerelést pontosan amutatott sorrendben kell elvégezni. Javasoljuk, hogy csak szakképzett személyzet végezze el a szerelést.

PL

Przed rozpoczęciem montażu proszę uważnie zapoznać się ze stosowną instrukcją. Aby zapewnić prawidłowe przeprowadzenie montażu należy wykonywać wszystkie czynności dokładnie wg przedstawionej kolejności. Polecamy montaż wyłącznie przez fachowy personel.

RU

Перед началом внимательно изучить инструкцию по монтажу. Чтобы гарантировать надлежащую и безошибочную компоновку, монтаж должен выполняться точно в показанной последовательности. Мы рекомендуем монтаж только силами компетентного персонала.

SI

Pred začetkom, prosimo, navodilo za montažo skrbno tudirajte. Za zagotovitev redne in nepomanjkljive izdelave se mora montaža izvesti natančno v prikaznem vrstnem redu.

IT

Per favore prima dell'inizio studiare accuratamente le istruzioni per il montaggio. Per garantire una realizzazione senza errori, il montaggio deve essere fatto rispettando esattamente la sequenza indicata. Consigliamo di far eseguire il montaggio esclusivamente da parte di personale esperto.

BG

Преди монтажа внимателно разучете инструкцията. Монтажът задължително трябва да се извърши в посочената последователност, за да отговаря на изискванията и да бъде безупречен. Не препоръчваме монтажът да се извършва от квалифициран персонал.

TR

Lütfen kurulum talimatlar başlamadan önce dikkatle iyice inceleyiniz. Do ru ve hatasız üretim sağlamak için, montaj gösterilen sırada tam olarak yapılmalıdır. Biz montajı sadece e itimli personel tarafından öneririz.

HR

Molimo Vas da upute omontaži prije po etka pažljivo pročitate. Kako bi se zajamila pravilna i besprijekorna izrada, montaža se mora izvesti točno po prikazanom redoslijedu. Preporuujemo montaż samo od strane stručnog osoblja.

NL/BL

Bestudeer de montagehandleiding a.u.b. zorgvuldig alvorens te beginnen. Om een volledig correcte en vlekkeloze opstelling te garanderen, moet demontage precies in de getoonde volgorde worden uitgevoerd. Wij raden aan om de montage alleen door vakkundig personeel te laten uitvoeren.

RO

Înainte de a începe, citiți cu atenție instrucțiunile de montaj. Pentru a se asigura un montaj corect și fără defecte, acesta trebuie realizat exact în ordinea indicată. Recomandăm ca montajul să fie făcut doar de personal calificat.

DK

Husk at læse monteringsvejledningen grundigt, inden du begynder. Arbejdsstrinene skal udføres i den viste rækkefølge for at sikre, at resultatet bliver helt rigtigt. Vi anbefaler, at du lader monteringsarbejdet udføre af en fagmand.

PT

Estudar as instruções de montagem antes do início. Para garantir uma constituição correcta e sem falhas, a montagem tem que ser efectuada exactamente na sequência indicada. Recomendamos que a montagem seja efectuada apenas por pessoal técnico especializado.

SE

Studera monteringsanvisningen noga innan du börjar att montera. För att garantera ett korrekt och felfritt uppförande, måste monteringen ske exakt och i den anvisade ordningsföljden. Vi rekommenderar att endast låta sakkunnig personal utföra monteringen.



DE

Entsorgen Sie die Verpackungen bzw. das Produkt nach Abnutzung Umweltgerecht.

GB

Please dispose of the packaging and of an old product no longer in use without any danger to the environment.

FR

Veuillez vous débarrasser de l'emballage ou du produit après son utilisation selon les conditions sur l'environnement.

ES

Desechar por favor el embalaje o producto ateniéndose a las normas ecológicas vigentes una vez que éste se haya desgastado.

CZ

Po použití likvidujte obal nebo výrobek ekologicky

SK

Obal resp. produkt po opotrebení zlikvidujte ekologicky.

HU

Kérjük, hogy a csomagolást, illetve a terméket elhasználódás után környezetkímélő módon takarítsa el.

PL

Produkt po zuyciu i jego opakowanie utylizować w ekologicznie właściwy sposób.

- RU** У паковку и изделие после амортизации утилизируйте в соответствии с экологическими требованиями.
- SI** Poskrbite za okolju prijazno odstranitev embalaže oz. produkta po uporabi
- IT** Non disperdere nell'ambiente e provvedere ad uno smaltimento ecologico dopo l'uso.
- BG** И зхвърляйте опаковката респ. вече негодния продукт според изискванията за аопа зване на околната среда.
- TR** Ambalaj ve ürünü kullanımdan sonra çevreye zarar vermeden yok edin.
- HR** Odstranite pakovanje odnosno proizvod nakon upotrebe ekološki.
- NL/BL** Voer de verpakking resp. het product na gebruik op milieuvriendelijke wijze af.
- RO** Elimina i ambalajul, respectiv produsul dup de s-a uzat, fără a afecta mediul înconjurător.
- DK** Forpackningsaffald respektive produktet skal fjernes miljørigtigt.
- PT** Elimine a embalagem ou o produto observando as normas ecológicas vigentes depois do seu desgaste.
- SE** Avfall från förpackning respektive produktet skall utföras miljökorrekt .

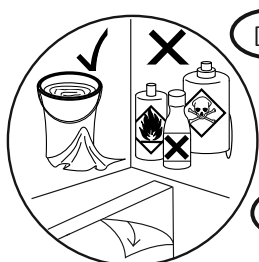

- DE** Pflegehinweis! Bitte nur mit einem Staubtuch oder einem feuchten Lappen reinigen. Keine scheuernden Mittel, Säure, Lösungsmittel, Spiritus, Azeton etc. verwenden. Vor Montage von Hochglanzfronten die Schutzfolie entfernen.
- GB** Care instructions! Please do only clean with a duster or a damp cloth. Do not use abrasive cleaning agents, acids, solvents, methylated spirits, or acetone etc.! Remove the protective foil before inserting the high-gloss front panels.
- FR** Indications d'entretien ! Ne nettoyer qu'avec un chiffon à poussière ou un chiffon humide. Ne pas utiliser de produits agressifs ni d'acides, de solvants, d'alcool, d'acétone, etc. Retirer le film protecteur avant le montage des façades brillantes.

- ES** Indicaciones de mantenimiento! Limpiar sólo con un trapo para el polvo o con un trapo húmedo. No deben utilizarse medios abrasivos, ácido, disolventes, alcohol, acetona, etc. Antes del montaje de frentes de alto brillo, retirar la lámina de protección.
- CZ** Pokyny pro ošet ování! Ist te, prosím, pouze prachovkou nebo vlhkým hadrem. Ním mýdlovým roztokem nepou ívat žádné abrazivní čistící prost edky, kyseliny, ředidla, líh, aceton atd. Před montáží čel s vysokým leskem odstraňte ochrannou fólii.
- SK** Pokyn k údržbe! Prosíme utiera len prachovkou alebo vlhkou handri kou. Ným mýdlovým roztokom, nepožívajte žiadne agresívne prostriedky, kyseliny, riedidlá, lieh, acetón a pod. Pred montážou odstráňte ochrannú fóliu z vysokolesklých čiel.
- HU** Ápolási útmutatás! Kérjük, hogycsak portörl kendövel vagy nedves ronggyal tisztítsa! Os szappanos víz oldattal tisztítsa. Ne használjon súrolószereket, savakat, oldószereket, alkoholt, acetont, stb. A magas fényezésű frontelemek beszerelése előtt a védőfóliát el kell távolítani.
- PL** Pielgnacja! Czy cié tylko przy pomocy suchej lub wilgotnej ściereczki. Nie wolno stosować jakichkolwiek środków ściernych, kwasów, rozpuszczalników, spirytusu, acetonu itp.! Przed montażem frontów na wysoki połysk należy zdjąć folię ochronną.
- RU** Указание по уходу! росьба чистить только тряпкой для пыли или влажной тряпкой. ни в коем случае не применять абразивные чистящие средства, кислоту, растворители, спирт, ацетон и т.п. Перед установкой снять защитную пленку с лицевых полированных сторон.
- SI** Navodilo za nego! istite, prosimo, le s krpo za prah ali z vlažno krpo. Ne uporabljajte sredstev za drgnjenje, kisline, topil, pirita, acetona itd. Pred namestitvijo visoko-sijajne prednje strani odstranite zaščitno folijo.
- IT** Istruzione di cura! Per favore pulire solo con un panno per rimuovere polvere o con uno straccio umido. Non utilizzare prodotti abrasivi, acidi, soluzioni, spirito, acetone, ecc.! Prima del montaggio, rimuovere la pellicola protettiva dalle parti anteriori ad alta lucentezza.
- BG** Указание за поддръжка! очиствайте само с кърпа за прах или влажен парцал. не използвайте абразивни препарати, киселина, разтворител, спирт, ацетон и т.н.! Преди монтаж на фасади с огледален блясък отстранете защитното фолио.
- TR** Bak m talimatları! Lütfen sadece bir toz bezi ya da nemli bir bezle temizleyiniz. Aşındırıcı maddeler, asitler, çözücüler, alkol, aseton vb kullanmayın! Montajdan önce yüksek parlak cephelerden koruyucu folyoyu çıkarın.
- HR** Uputa o njegovanju! istiti samo jednom maramom za pra inu ili jednom vla nom krpom. Ne koristite abrazivna sredstva, kiseline, otapala, benzin, aceton i slično. Prije montaže otklonite zaštitnu foliju od visoko sjajne prednjice.
- NL/BL** Onderhoudsinformatie! A.u.b. alleen reinigen met een stofdoek of een vochtige lap. Geen schurende reinigingsmiddelen, zuren, oplosmiddelen, alcohol, aceton, etc. gebruiken! Voor montage van hoogglansfronten de beschermfolie verwijderen.
- RO** Îndica ie privind întreținerea! Rug ma se cură a doar cu o cârp de ters praful sau cu o lavet umedă. Nu utiliza i agenți abrazivi, acizi, solvenți, spirt, aceton etc. Înainte de montarea fronturilor foarte lucioase, îndepărtați folia de protecție.
- DK** Pleje! Rengöring foretages med en støveklud eller en fugtig klud. Brug ingen skurende midler, syre, opløsningsmidler, spiritus, azetone etc. Fjern beskyttelsesfolien inden montering af højglansfronter.
- PT** Indicação de tratamento! Limpar apenas com um pano suave ou humedecido. Não usar produtos abrasivos, ácidos, solventes, álcool etílico, acetona, etc. Antes da montagem das frentes de briho intenso remover a película de proteção.
- SE** Skötselanvisning! Rengör antingen med torr dammtrasa eller med fuktig trasa. inga skurmedel, syror, sprit, lösningsmedel, aceton osv. får användas. Avlägsna skyddsfilmen från högglansfronterna före montering.

5 x 35 mm

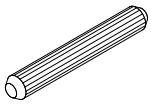

24 x A

5 x 60 mm

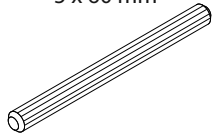

5 x B



34 x C

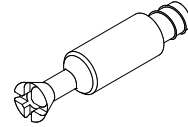

34 x D

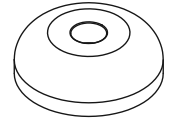

5 x E

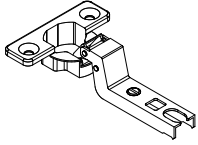

2 x F

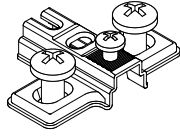

2 x G

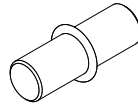

12 x H

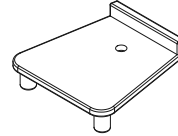

1 x I

2,7 x 20 mm

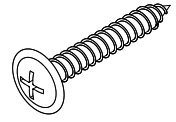

5 x J

4 x 27 mm

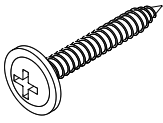

2 x K

3 x 13 mm

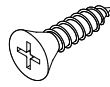

1 x L

3 x 17 mm

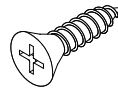

4 x M

3,5 x 15 mm

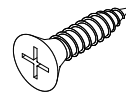

5 x N

3,5 x 20 mm

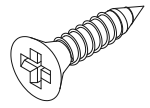

4 x O

4 x 17 mm

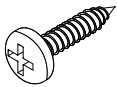

1 x P

6,3 x 13 mm



9 x Q

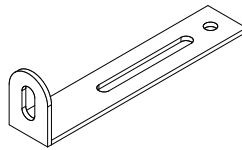

1 x R

4 x 15 mm

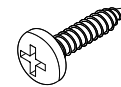

2 x S

4 x 40 mm

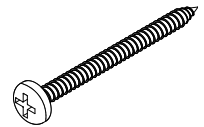

1 x T

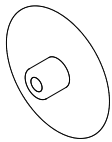

34 x U

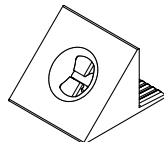

4 x V

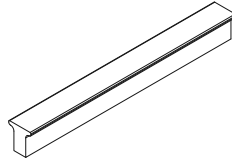

1 x W

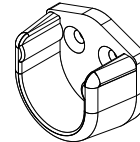

2 x X

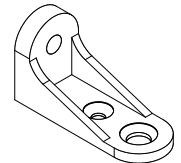

1 x Y

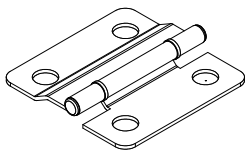

2 x Z

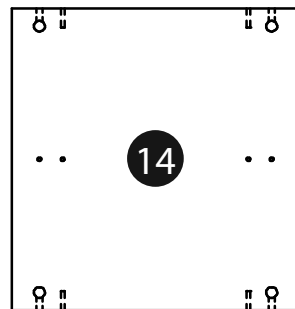
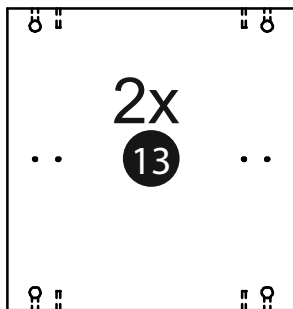
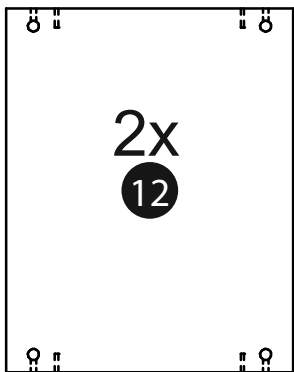
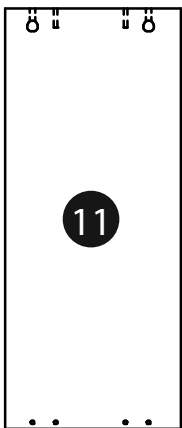
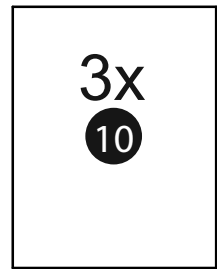
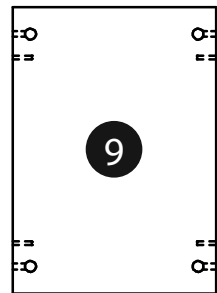
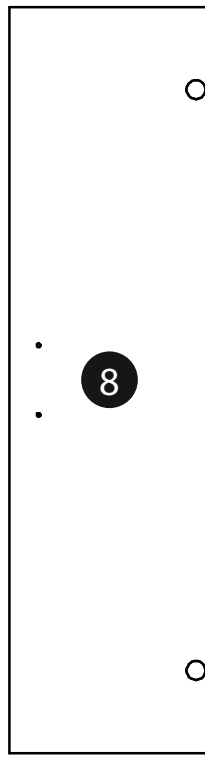
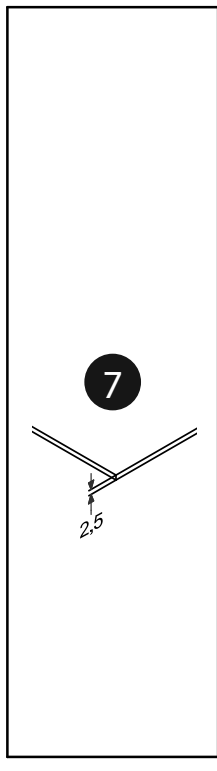
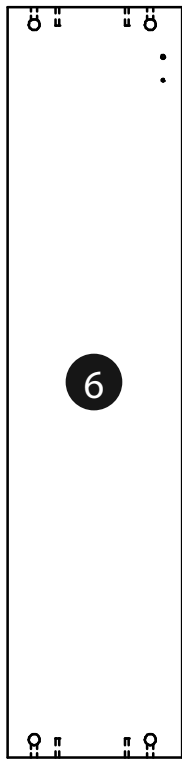
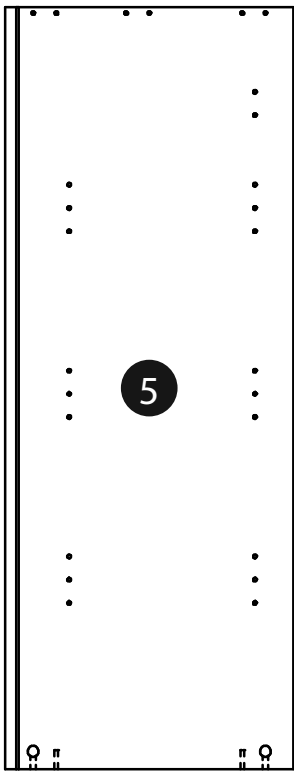
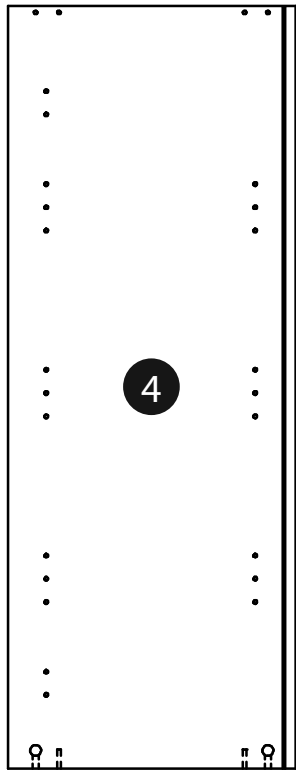
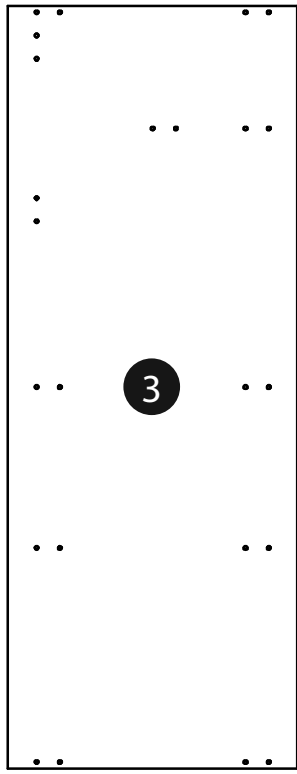
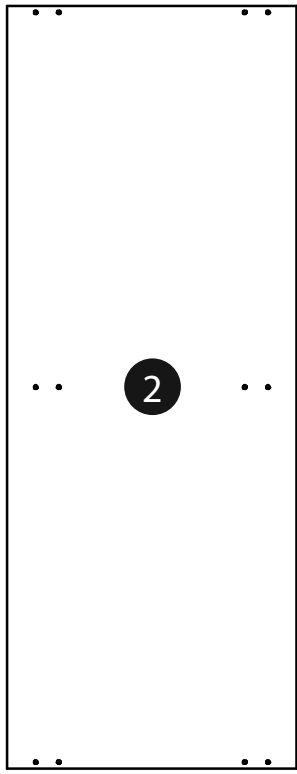
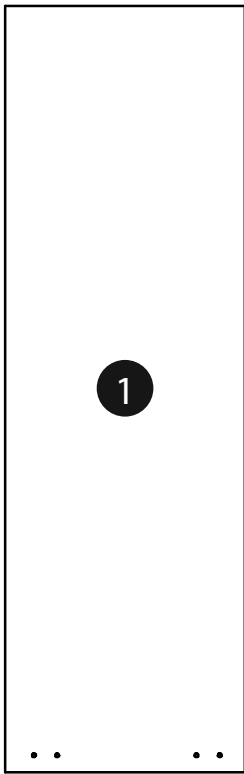

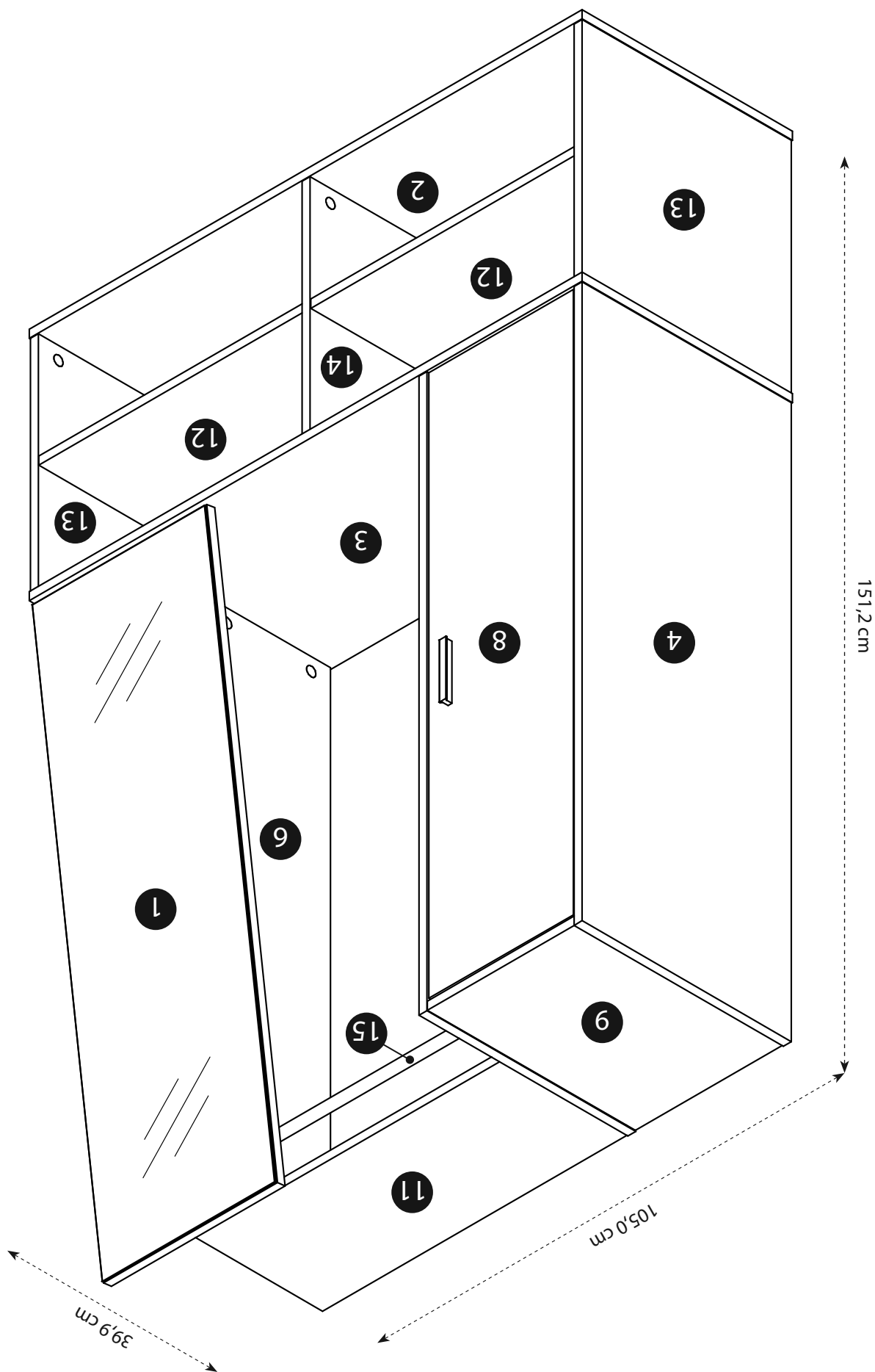

1

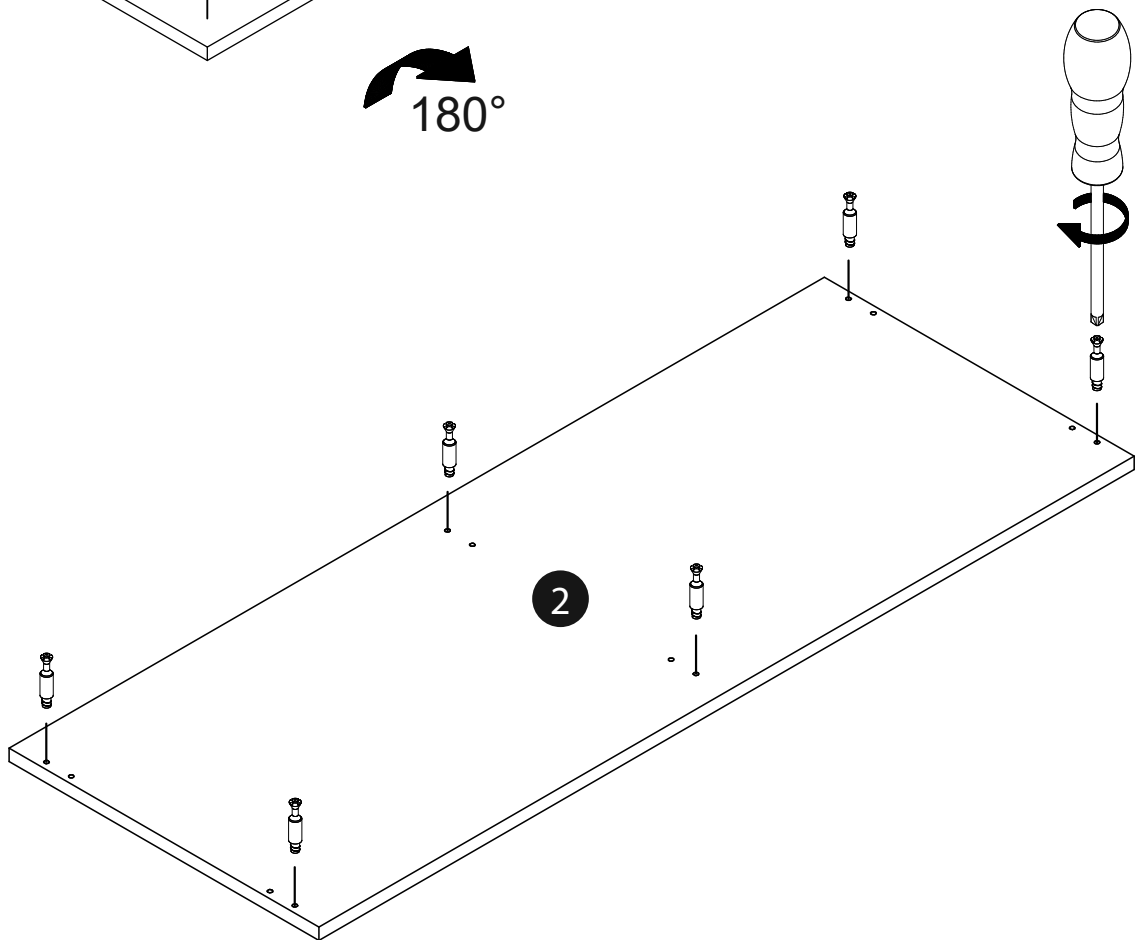
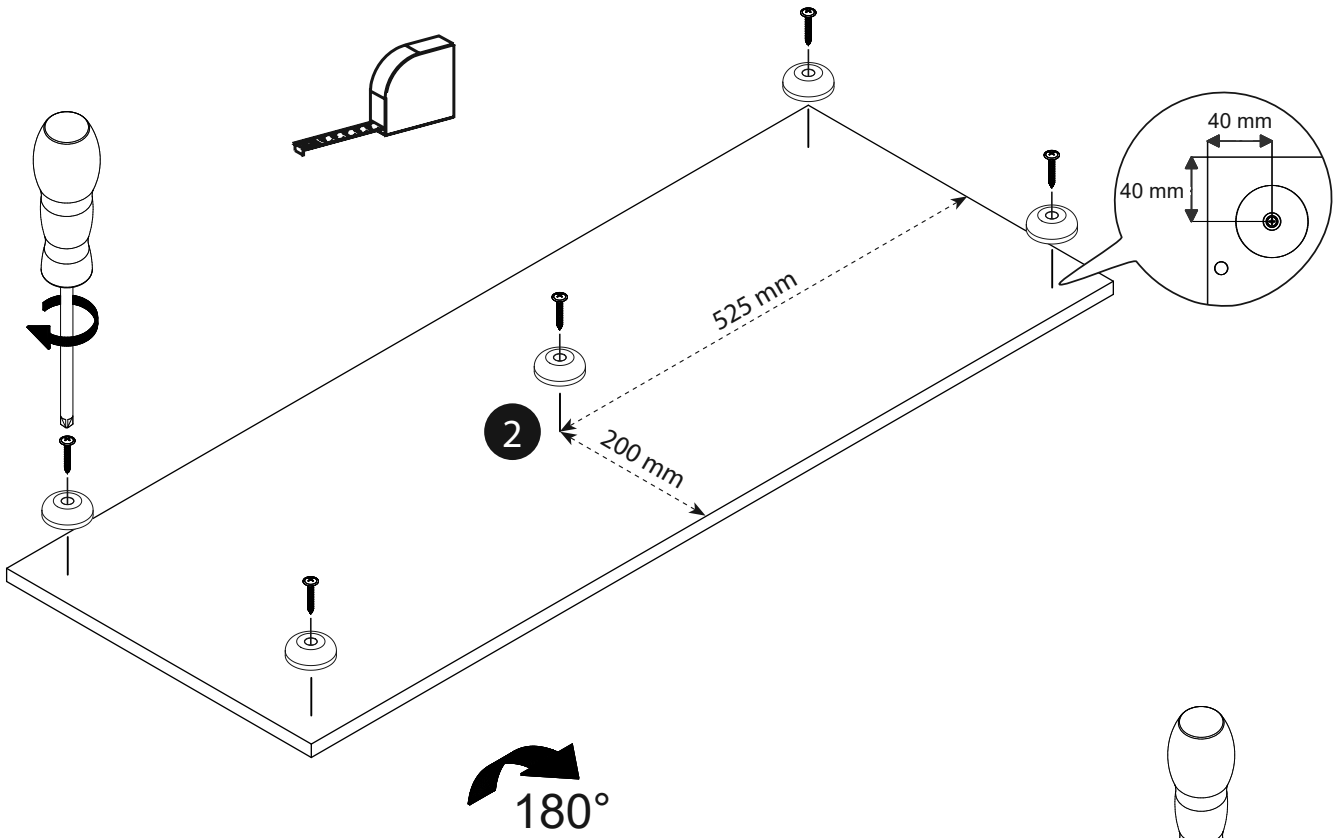
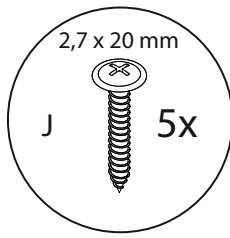
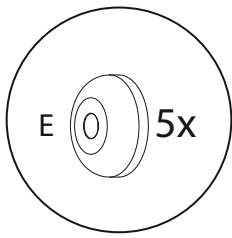
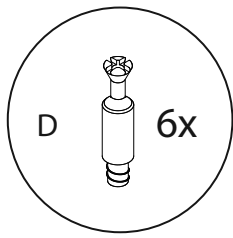

2

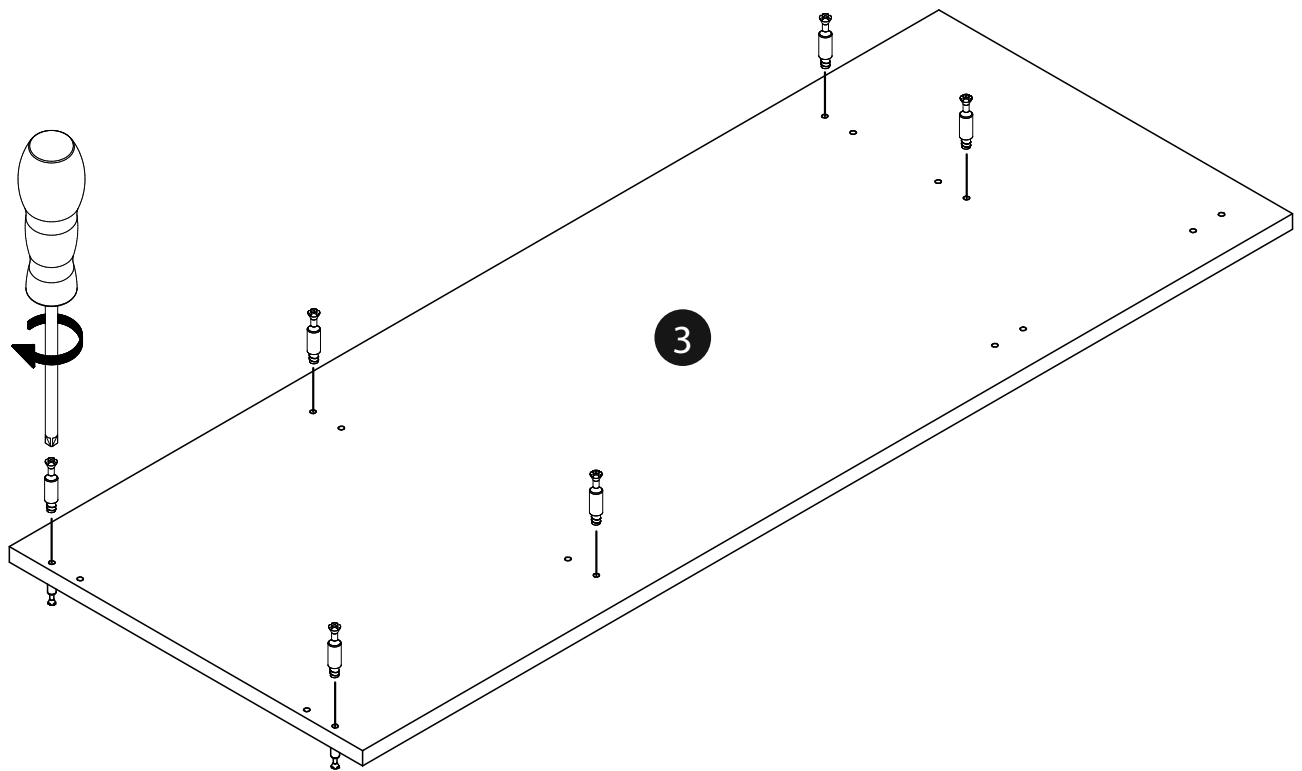
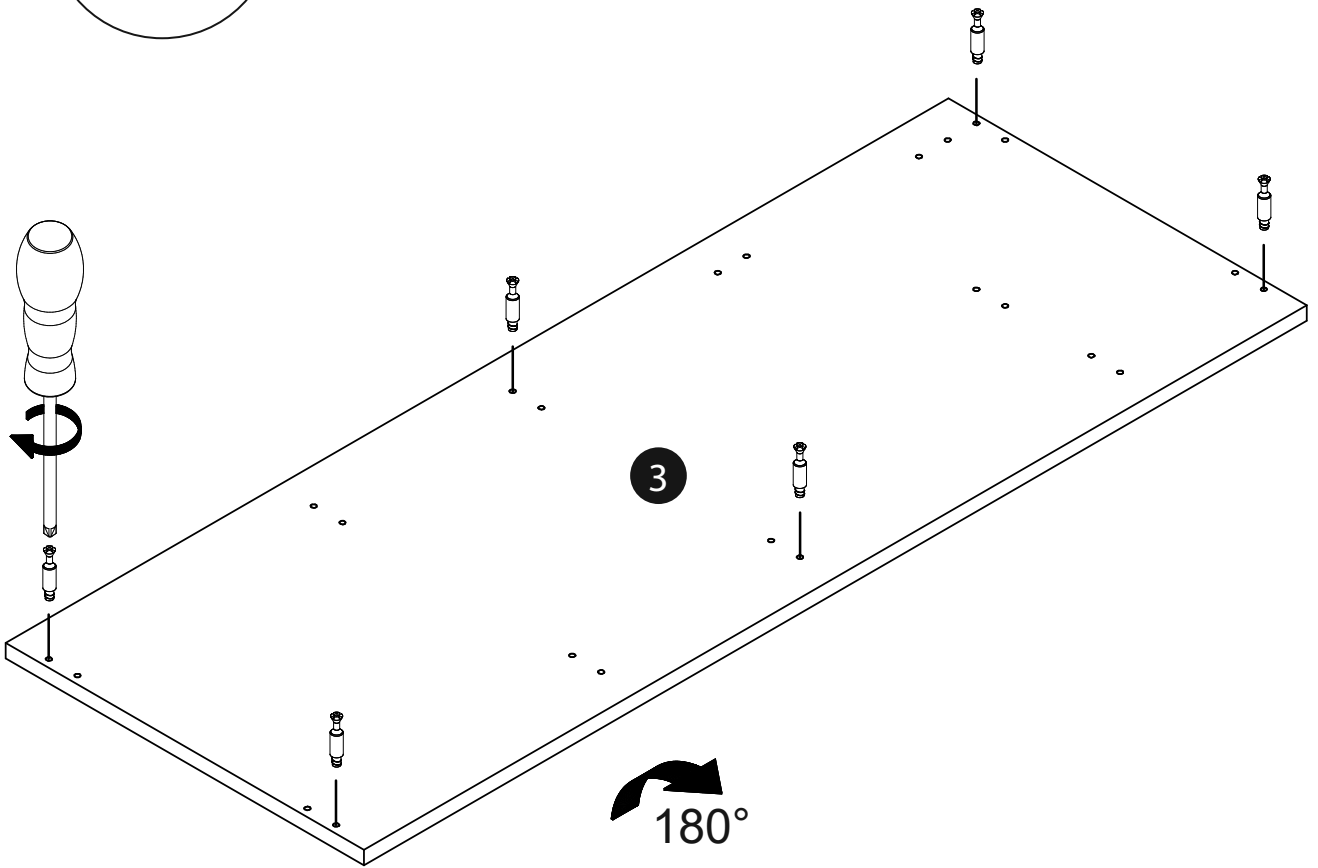
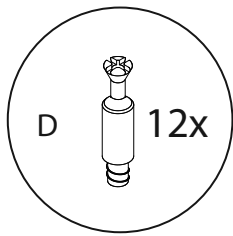

3

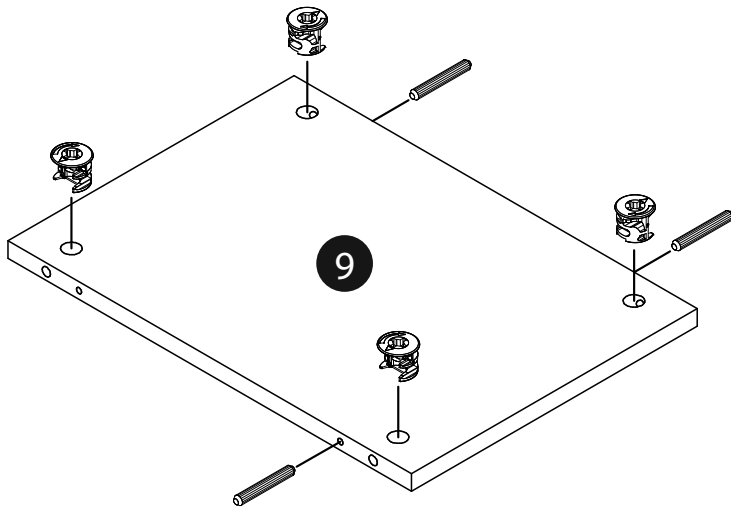
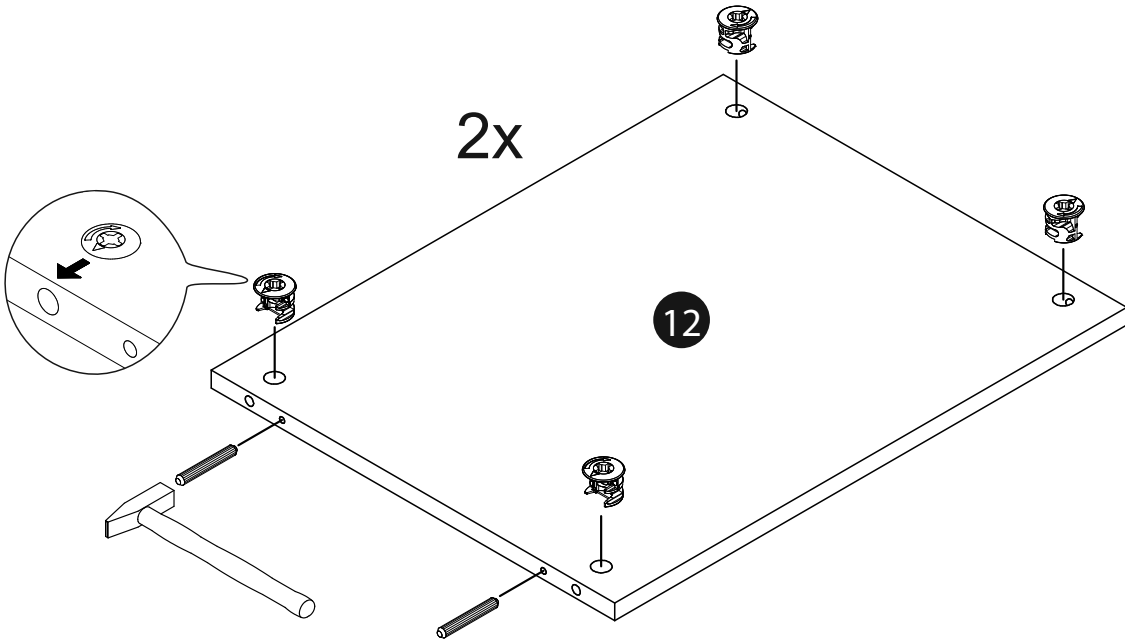
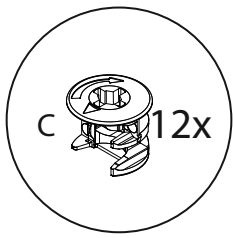
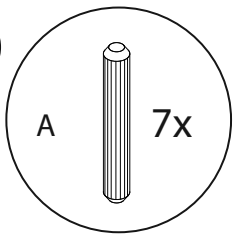

4

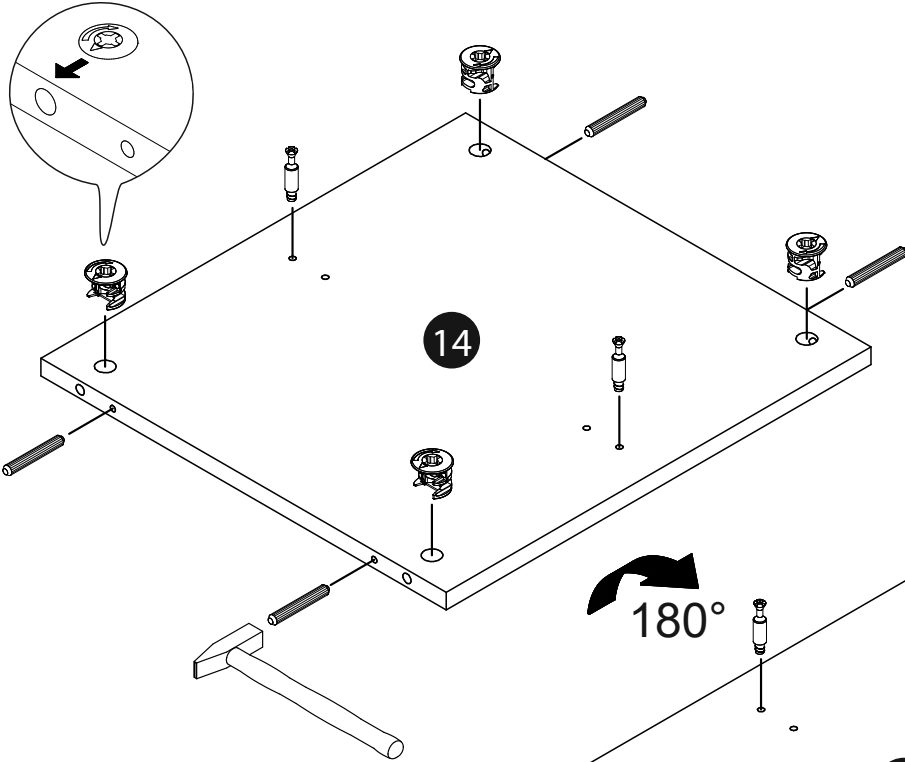
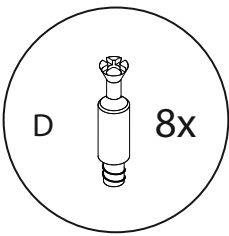
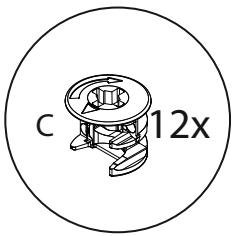
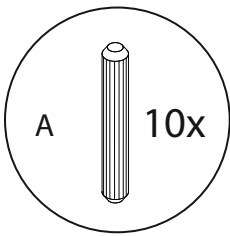

180°

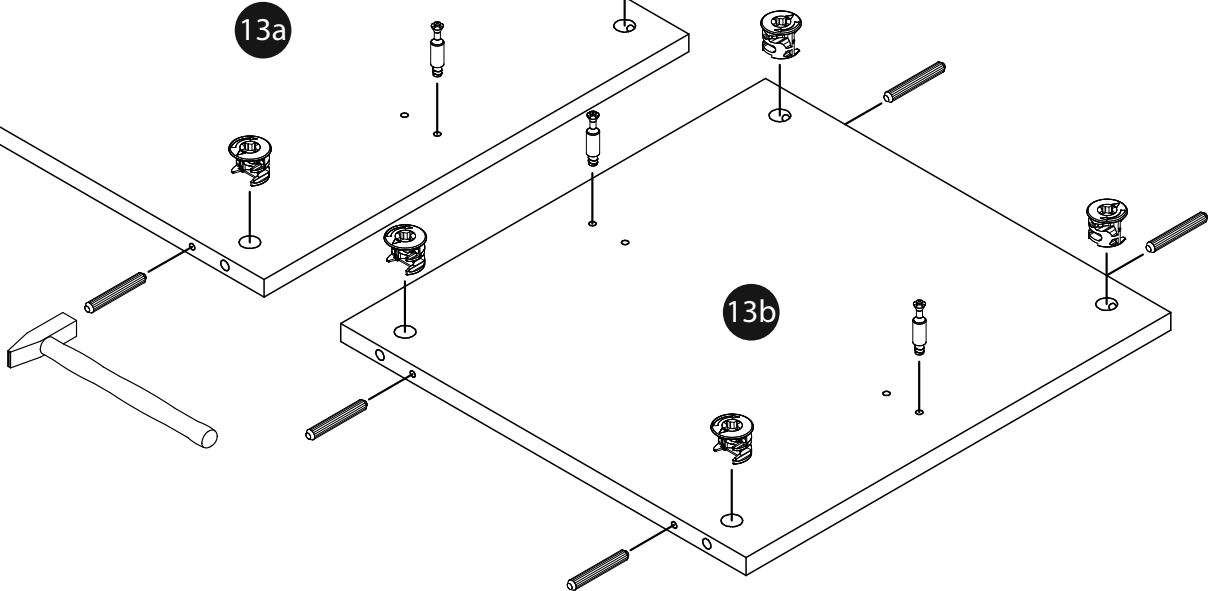
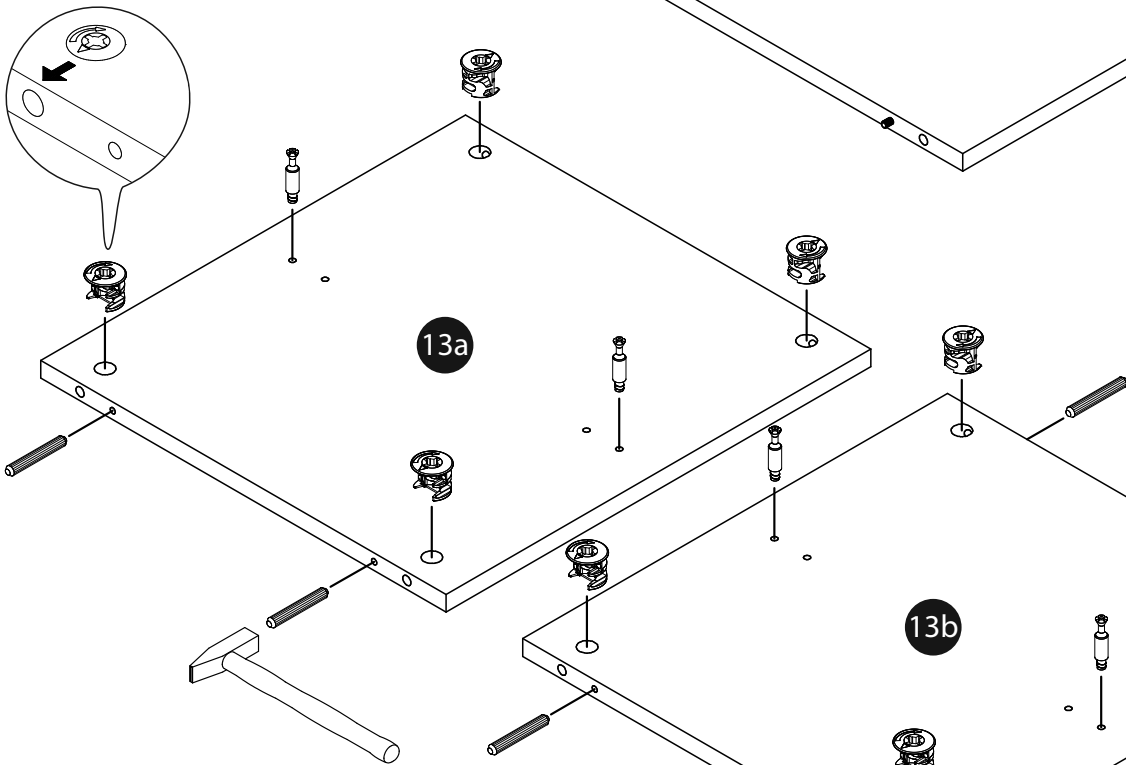
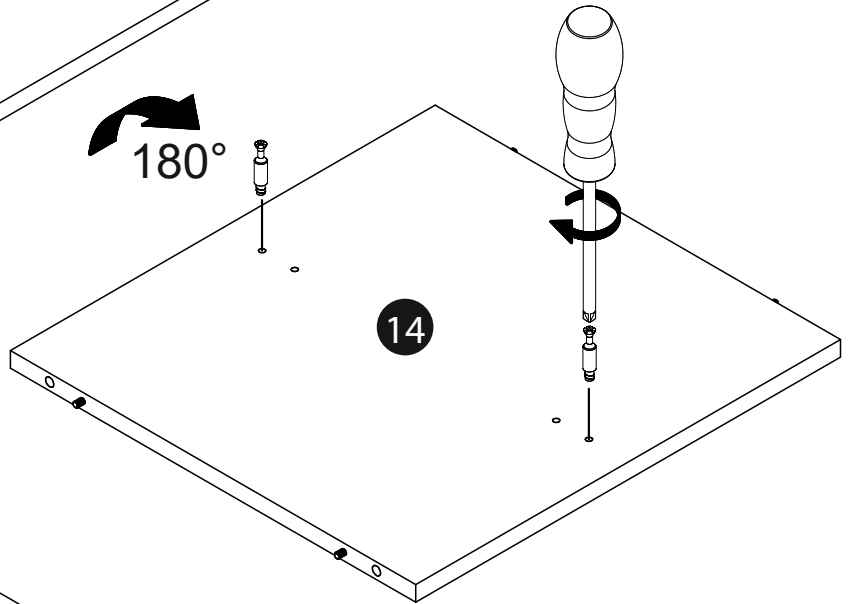

5

A 5x



C 6x

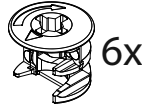

D 4x



3 x 17 mm

M 4x



6,3 x 13 mm

Q 1x



R 1x

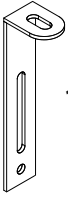

4 x 15 mm

S 2x

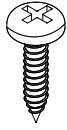

X 2x



Y 1x

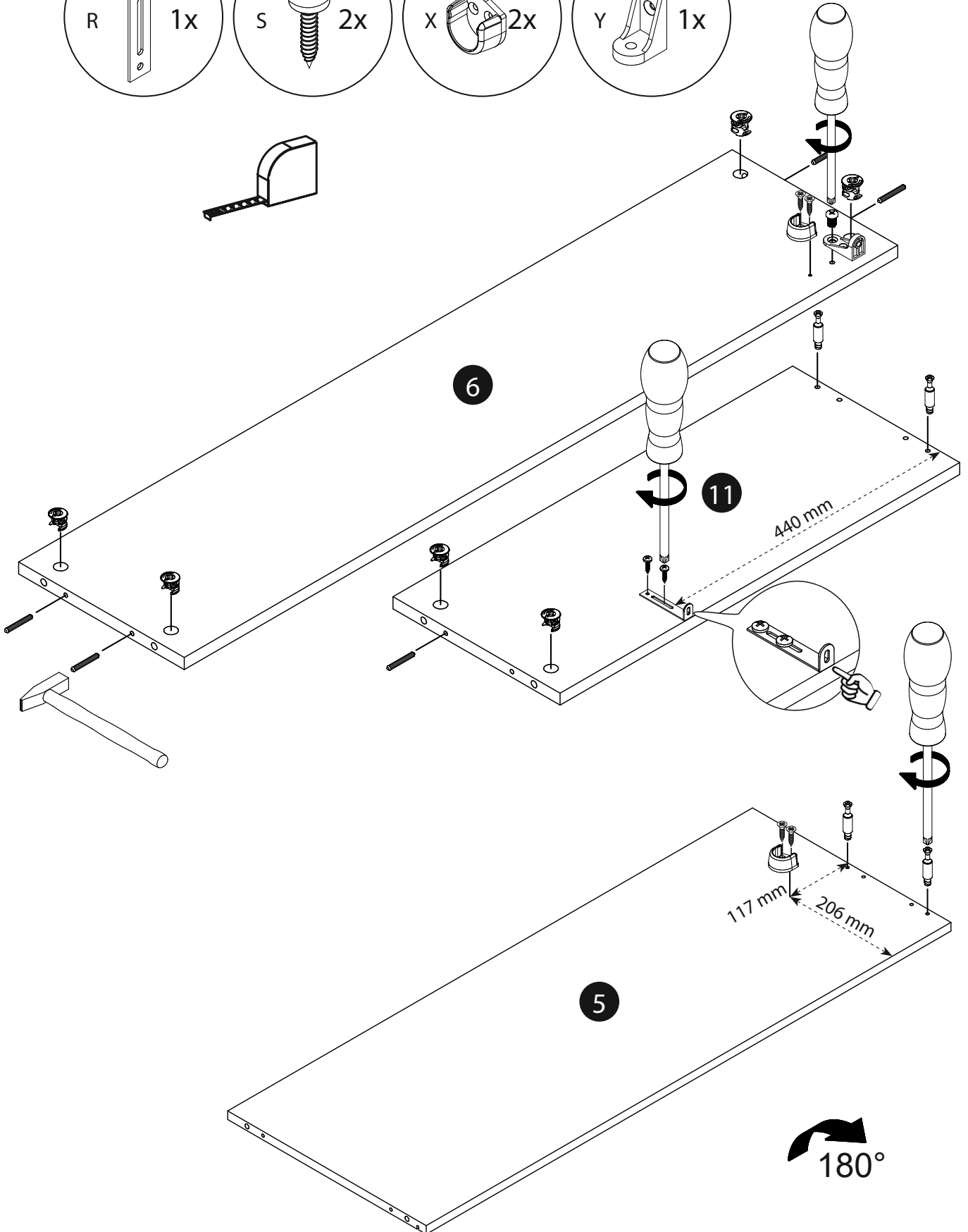
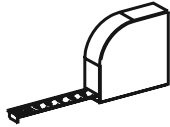
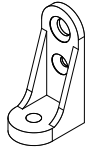

6

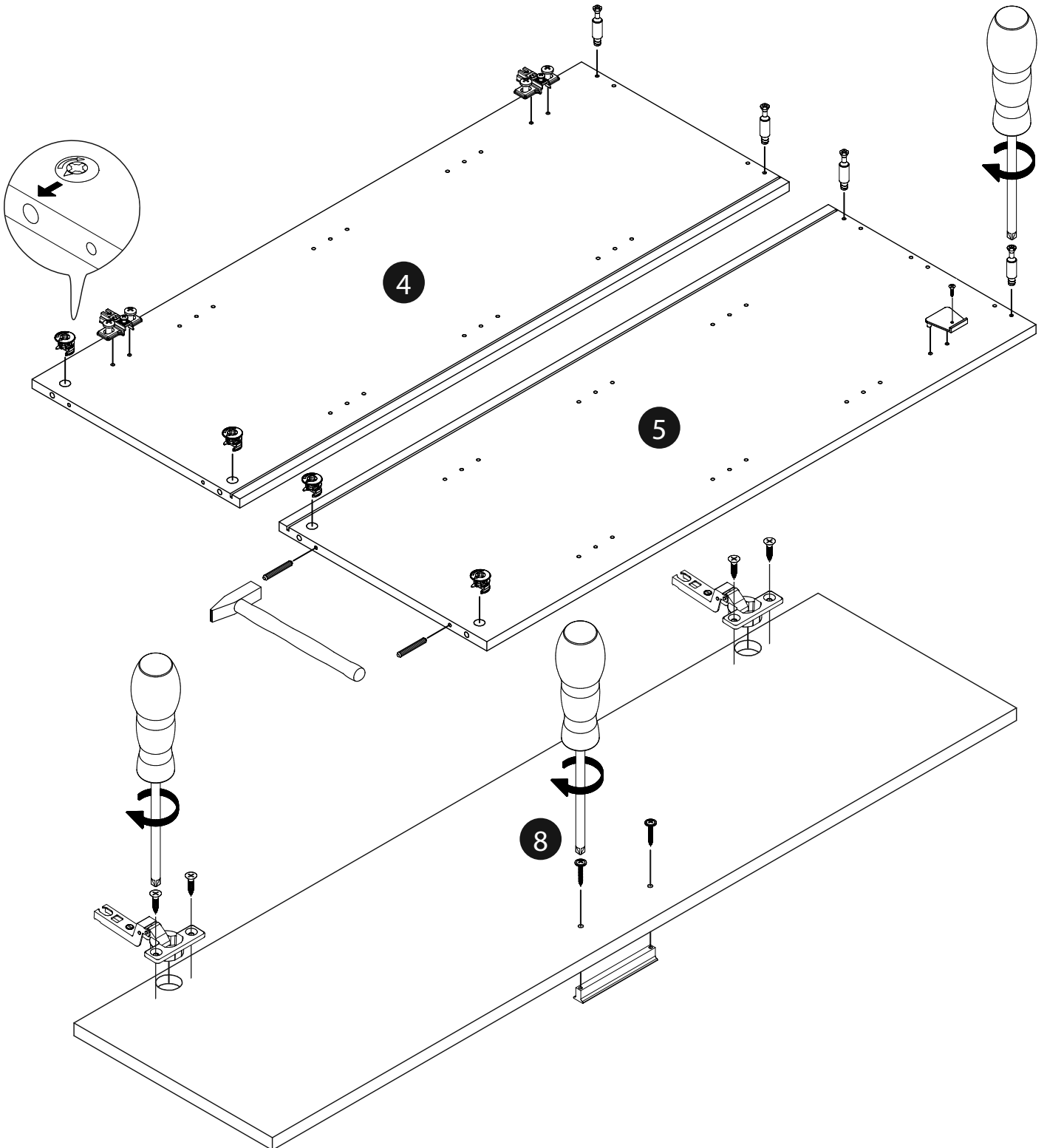
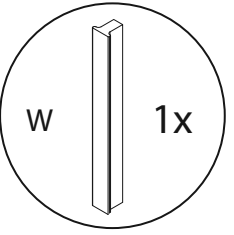
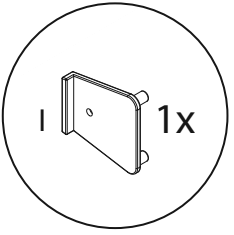
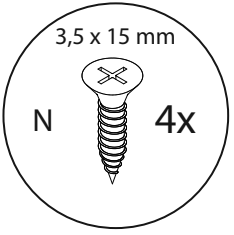
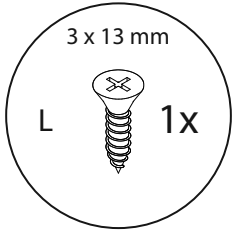
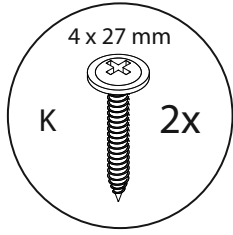
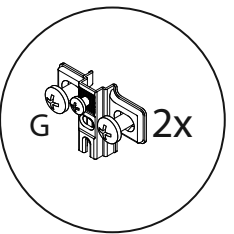
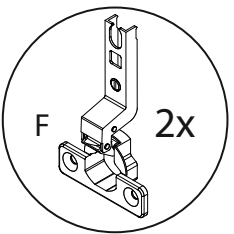
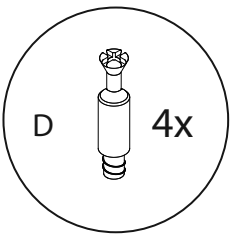
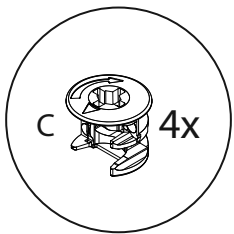
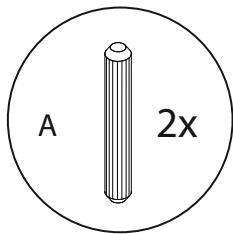

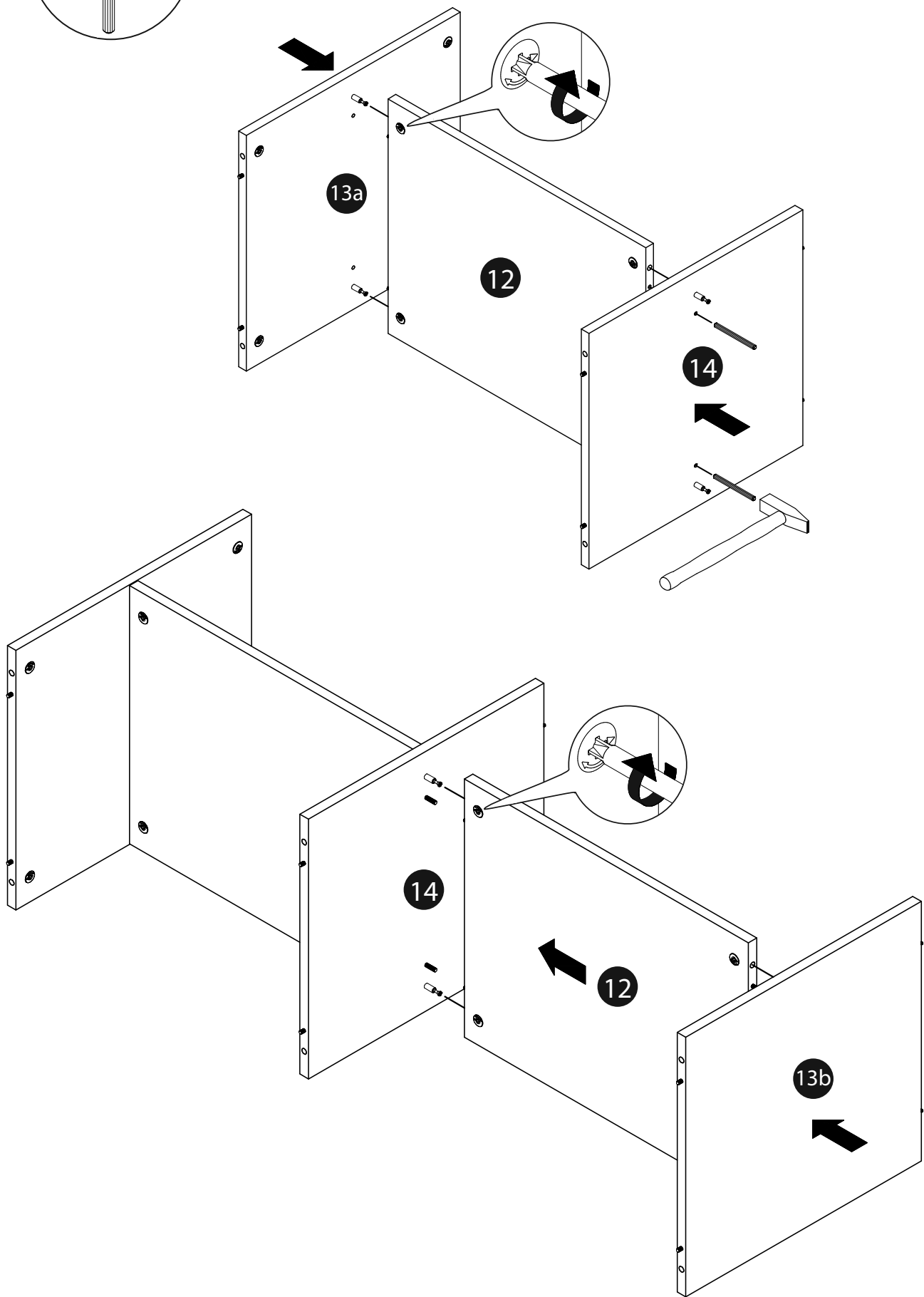
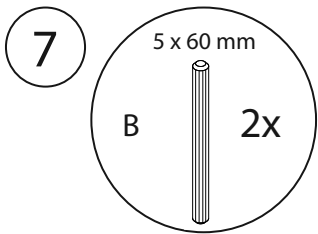

8

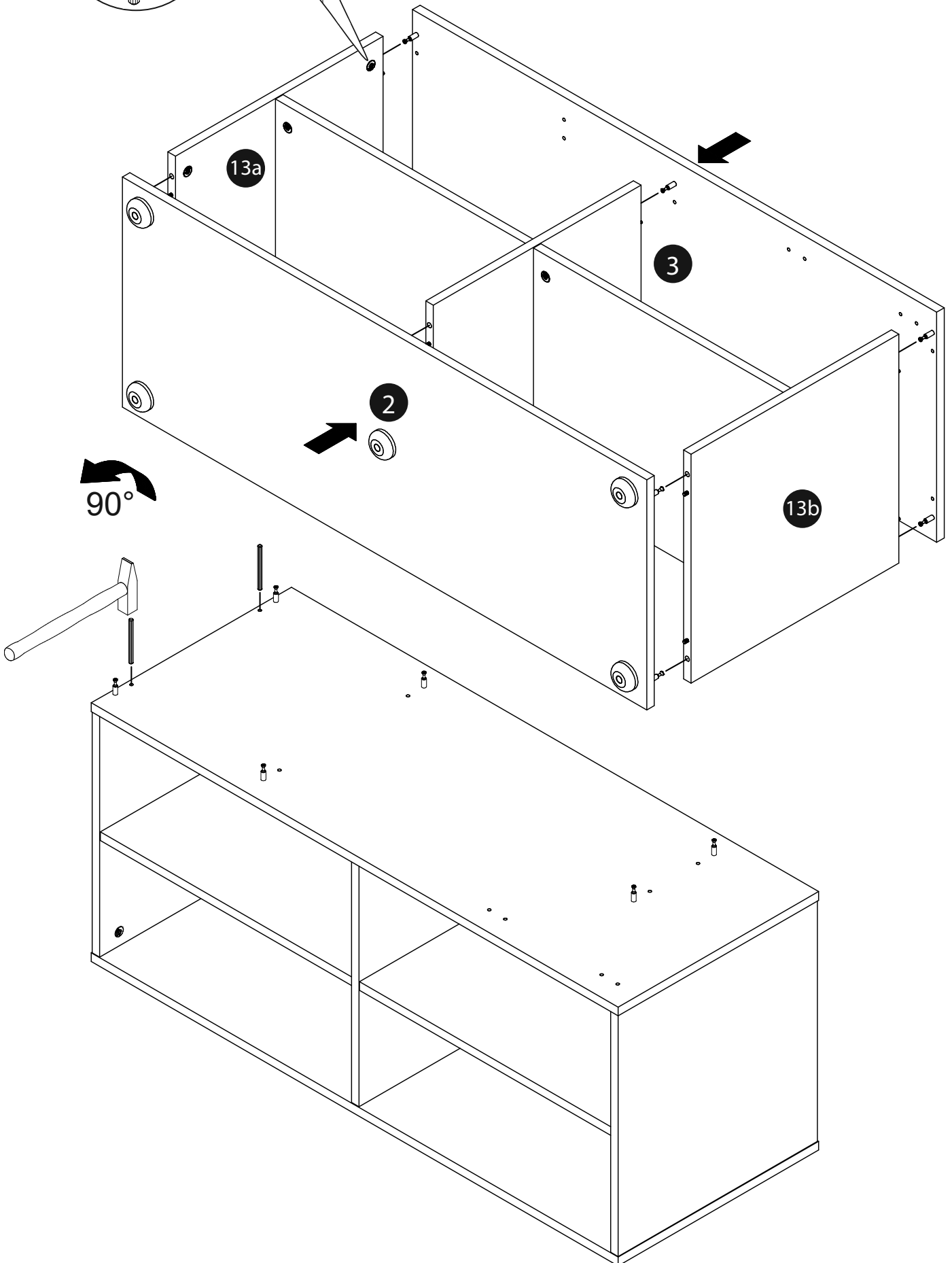
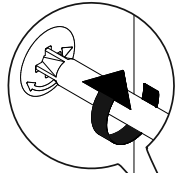
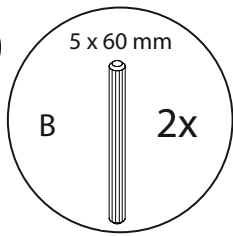

9

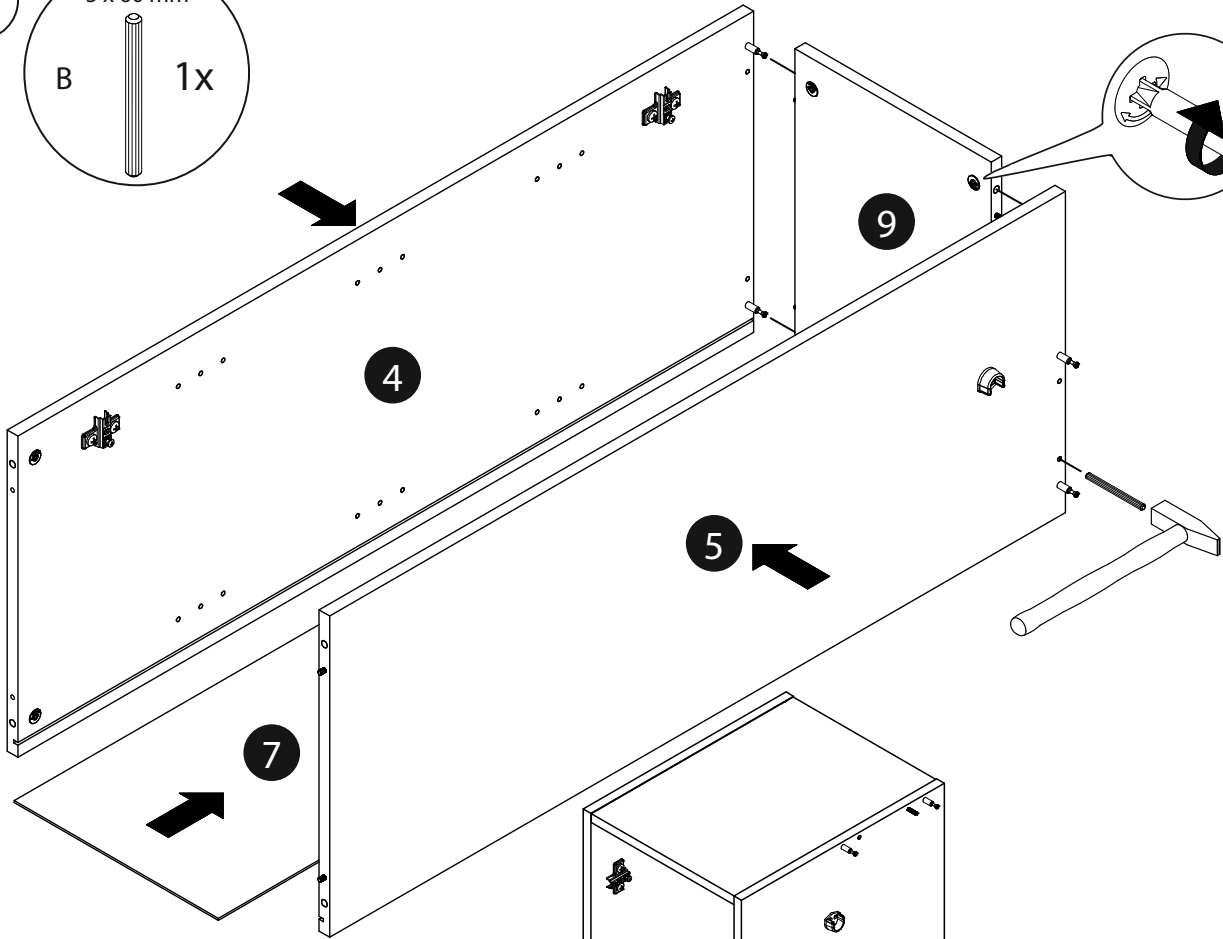
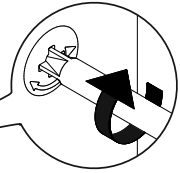
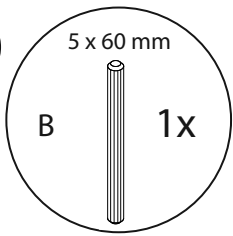

90°

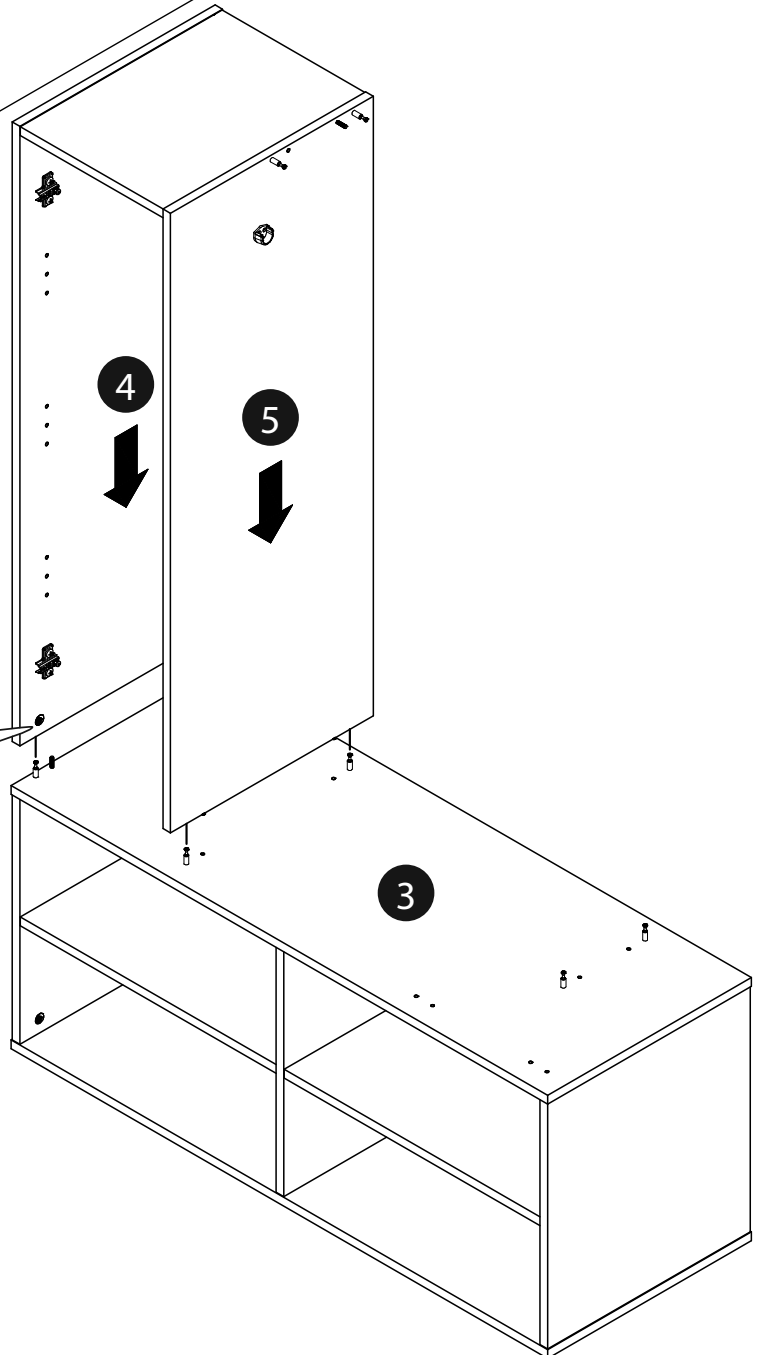
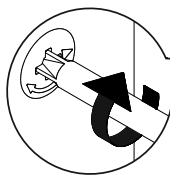

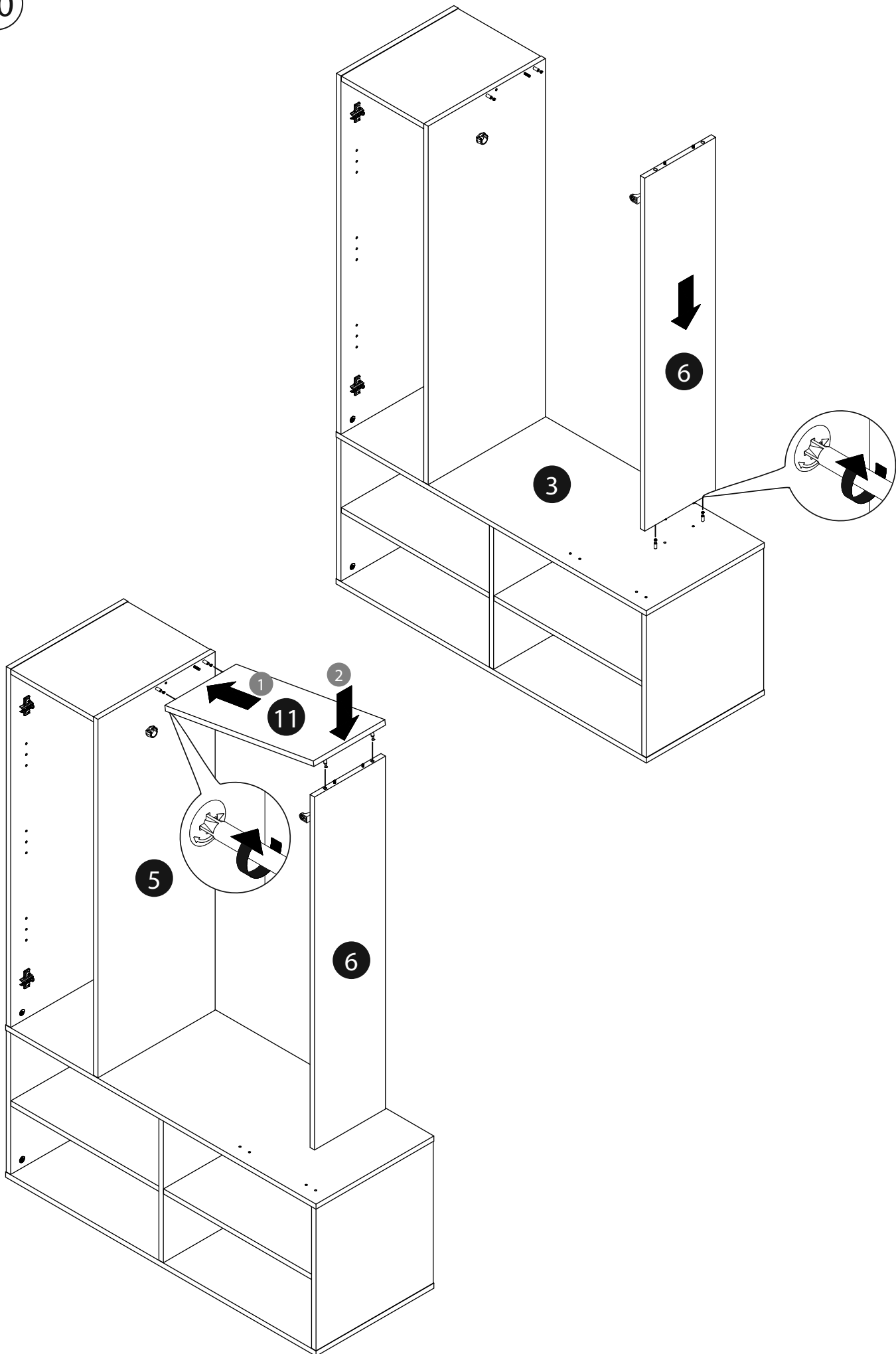

11

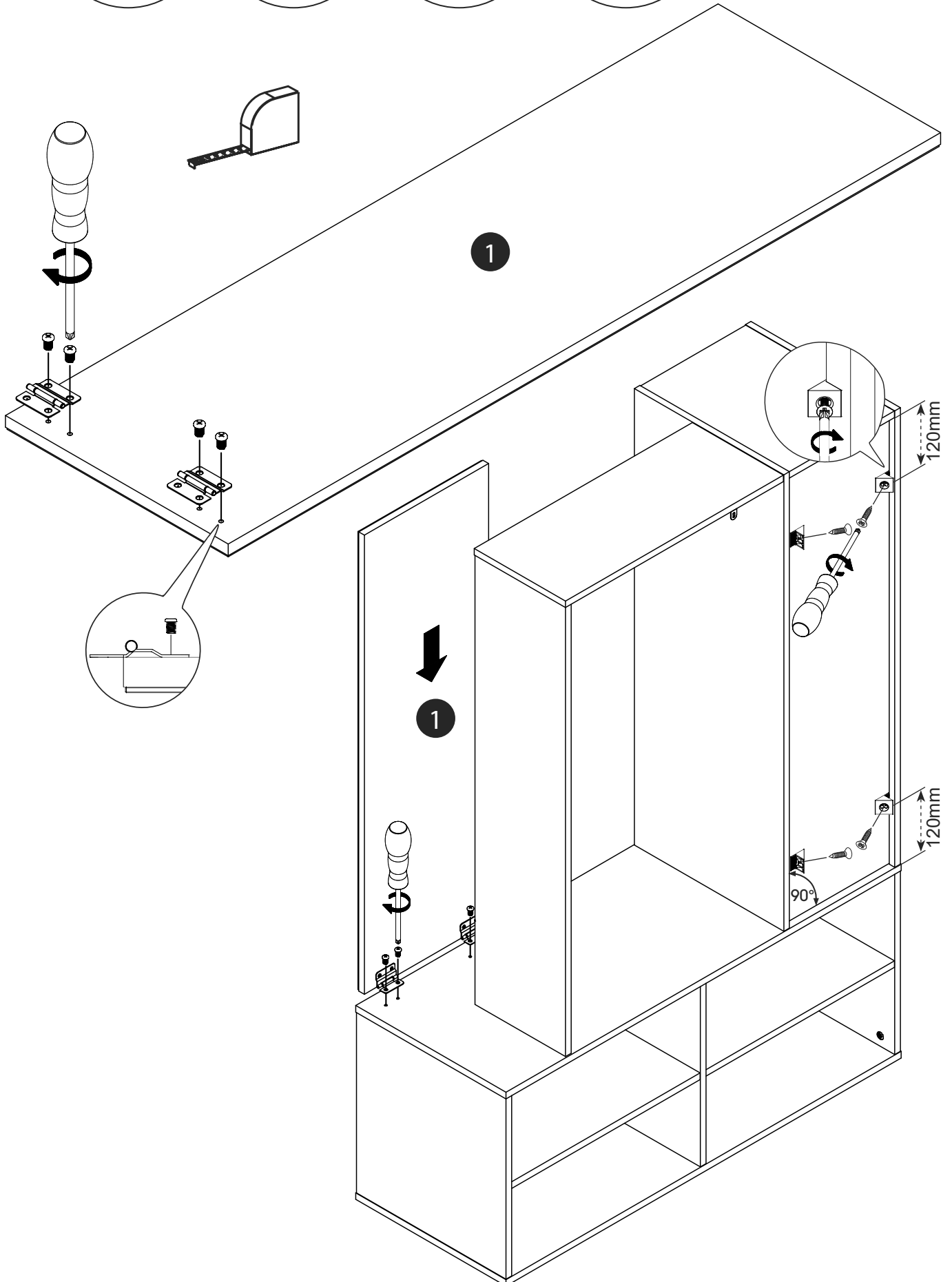
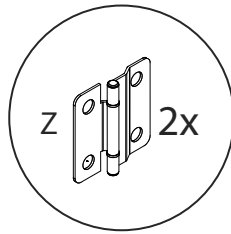
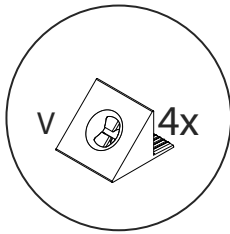
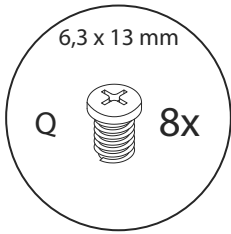
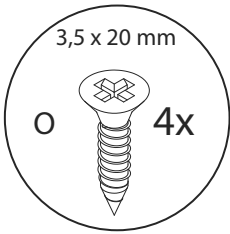

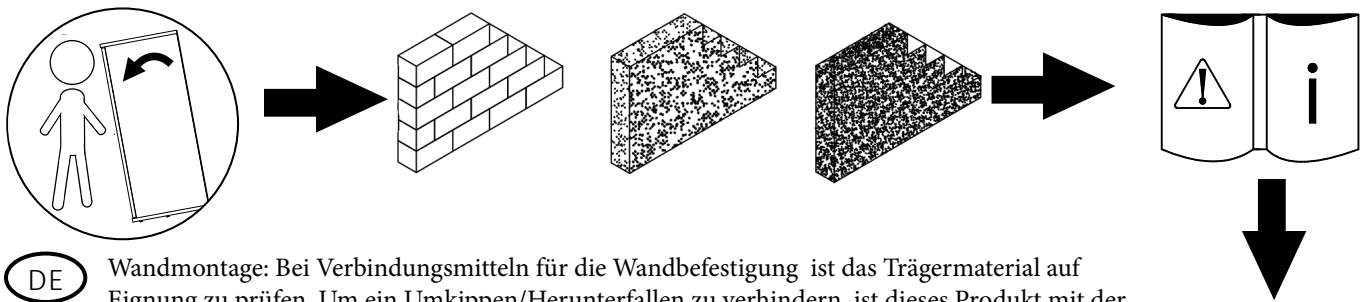

DE Wandmontage: Bei Verbindungsmitteln für die Wandbefestigung ist das Trägermaterial auf Eignung zu prüfen. Um ein Umkippen/Herunterfallen zu verhindern, ist dieses Produkt mit der mitgelieferten Wandbefestigung zu verwenden.

GB Wall mounting: Check that the substrate material is suitable for using wall fasteners. To prevent the product from falling over or falling off, affix it with the wall bracket supplied.

FR Montage mural : en ce qui concerne les éléments d'attache pour la fixation murale, il convient de vérifier la compatibilité du matériau support. Afin d'éviter tout basculement ainsi que toute chute, ce produit doit être utilisé avec la fixation murale fournie.

ES Montaje en la pared: Si se utilizan medios de unión para el montaje en la pared, se ha de comprobar la idoneidad del material de soporte. Para evitar vuelcos/caídas, este producto tiene que utilizarse con la sujeción de pared suministrada.

CZ Montáž na zeď: U spojovacího materiálu pro uchycení na zeď se musí zkontrolovat vhodnost podkladu. Aby se zabránilo převrácení/pádu, musí se tento výrobek používat s dodávaným uchycením na zeď.

SK Montáž na stenu: Pri spojovacích materiáloch pre pripojenie na stenu musíte preveriť vhodnosť nosného materiálu. Aby sa zabránilo prevráteniu/spadnutiu, musíte tento produkt použiť spolu s dodaným pripojením na stenu.

HU Fali szerelés: A fali rögzítéshez használt rögzítőelemek esetén ellenőrizni kell a tartóanyag alkalmasságát. A felborulás/leesés elkerülése érdekében a termékhez mellékelt fali rögzítőelemeket kell használni.

PL Montaż naścienny: W przypadku elementów przyłączeniowych do montażu naściennego należy sprawdzić materiał nośne pod kątem przydatności. Aby zapobiec przewróceniu/spadnięciu, produkt należy użytkować z zastosowaniem dostarczonego zamocowania ściennego.

RU Настенный монтаж: при наличии соединительных средств, предназначенных для крепления к стене, материал-носитель следует проверить на предмет пригодности. В целях предотвращения опрокидывания/падения данное изделие необходимо использовать с настенным креплением, входящим в комплект поставки.

SI Stenska montaža: Ko želite uporabiti pritrdilna sredstva za stensko montažo, preverite primernost nosilnega materiala. Da preprečite prevrnitev/padec, uporabite ta izdelek skupaj s priloženimi elementi za stensko montažo.

IT Montaggio a parete: per i mezzi di collegamento del fissaggio a parete si deve verificare la capacità portante del materiale. Per evitare ribaltamenti/cadute, questo prodotto deve essere utilizzato con il fissaggio a parete fornito.

BG Монтаж на стена: При съединителни средства за крепежа за стена трябва да се провери годността на носещия материал. За да се предотврати преобръщане/падане, този продукт трябва да се използва с доставения крепеж за стена.

TR Duvara montaj: Duvar sabitlemesine yönelik bağlantı araçlarında taşıyıcı malzemenin uygunluğu kontrol edilmelidir. Devrilmeyi/düşmeyi önlemek için ürün, birlikte teslim edilen duvar sabitlemesi ile kullanılmalıdır.

HR Zidna montaža: Kod spojnih sredstava za zidno pričvršćivanje treba ispitati noseći materijal o njegovoj prikladnosti. Da bi se spriječilo prevrtanje/padanje treba se za ovaj proizvod primijeniti dostavljeni materijal za pričvršćivanje na zid.

NL/BL Wandmontage: bij verbindingsmiddelen voor wandmontage moet het dragermateriaal op geschiktheid worden gecontroleerd. Gebruik dit product met de bijgeleverde muurbeugel om kantelen/vallen te voorkomen.

RO Montajul pe perete: În cazul mijloacelor de conectare pentru fixarea de perete, trebuie să se verifice materialul portant cu privire la compatibilitatea acestuia. Pentru a împiedica o răsturnare/cădere, acest produs trebuie să fie utilizat cu fixarea de perete furnizată.

DK Vægmontage: Ved fastgørelsesanordninger til vægmontering skal bærematerialets egnethed kontrolleres. For at forhindre at produktet vælter eller falder ned, skal det bruges sammen med den medfølgende vægfastgørelse.

PT Montagem na parede: Verificar se o material de suporte é adequado para os meios de fixação na parede. Para evitar que vire/caia, este produto deve ser utilizado com a fixação de parede fornecida em conjunto.

SE Vägghmontering: Kontrollera att materialet i väggen är lämpligt för fästansordningarna för vägghmontering. För att förhindra att produkten tippas över eller faller ner, ska den fästas med den medföljande vägghmonteringen.

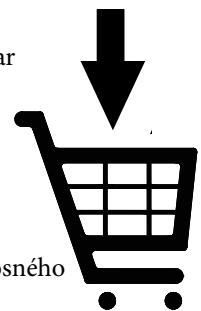
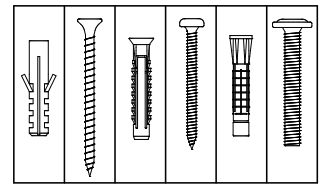

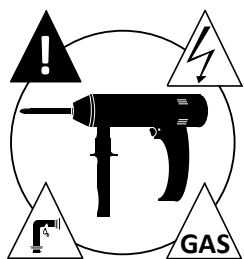

- (DE) Bevor Sie zur Bohrmaschine greifen, sollten Sie in jedem Fall in der Wand nach Strom-, Wasser- und Gasleitungen suchen. Nur wenn Sie genau wissen, wo die Leitungen verlaufen, können Sie Beschädigungen mit hohen Folgekosten oder gar lebensgefährliche Unfälle vermeiden.
- (GB) Before starting to drill, always look for electricity cables and gas or water pipes in the wall. Avoiding damage with high ensuing costs or even life-threatening accidents is only possible if you know the exact location of cables and pipes.
- (FR) Avant de procéder au perçage, veuillez dans tous les cas chercher les lignes électriques, conduites d'eau et de gaz dans le mur. Ce n'est que si vous savez précisément où se trouvent ces conduites que vous pouvez éviter tout dommage coûteux ou même tout accident mortel.

- (ES) Antes de agarrar la taladradora, debería buscar en cualquier caso conductos de electricidad, agua y gas en la pared. Sólo si sabe exactamente por dónde transcurren los conductos puede evitar daños con altos costes consecuentes o incluso accidentes con peligro de muerte.
- (CZ) Než použijete vrtačku, vždy ve zdi vyhledejte elektrorozvody, rozvody vody a plynu. Jen pokud budete přesně vědět, kudy rozvody vedou, můžete zabránit škodám s vysokými následnými náklady nebo dokonce život ohrožujícím úrazům.
- (SK) Skôr, než sahniete po vrtačke, musíte v každom prípade v stene prehľadať prítomnosť elektrických, vodovodných a plynových vedení. Len ak presne viete, kadiaľ prebiehajú vedenia, môžete zabrániť poškodeniam s vysokými následnými nákladmi ba dokonca životu nebezpečným úrazom.
- (HU) Mielőtt fúrni kezdene, ellenőrizzék, hogy a falban nem futnak-e áram- víz- és gázvezetők vezeték. A költséges károk és az akár életveszélyes balesetek csak akkor kerülhetők el, ha pontosan tudják, hogy hol futnak a vezeték.
- (PL) Przed wykonaniem otworu w ścianie należy zawsze sprawdzić, czy nie znajdują się w niej przewody elektryczne, rury z wodą lub gazem. Tylko wiedząc, gdzie dokładnie znajdują się przewody, można uniknąć dodatkowych kosztów związanych ze szkodami a nawet śmiertelnych wypadków.
- (RU) Прежде чем взять дрель, в любом случае вы должны отыскать в стене электропроводку, водопровод и газопровод. Только если вы точно знаете, где проходят эти проводки, вы сможете избежать повреждений, связанных с большими прямыми и косвенными затратами, или даже опасных для жизни несчастных случаев.
- (SI) Preden uporabite vrtni stroj, morate na vsak način poiskati morebitne električne, vodovodne in plinske vode. Šele potem, ko točno veste, kje potekajo vodi, se lahko izognete možnosti dragih poškodb in življenjsko nevarnim nezgodam.
- (IT) Prima di utilizzare il trapano, verificare sempre la presenza di linee di corrente, acqua e gas nella parete. Solo se si sa con precisione dove si trovano le linee è possibile evitare danni con costi elevati e la possibilità di infortuni pericolosi per la vita.
- (BG) Преди да започнете работа с бормашината, трябва при всички обстоятелства да потърсите електрически проводници, водо- и газопроводни тръби в стената. Само когато знаете точно къде преминават тези проводници и тръби, можете да избегнете повреди с високи последващи разходи или дори злополуки с опасност за живота.
- (TR) Matkayı kullanmadan önce duvarda mutlaka elektrik, su ve gaz hatlarını tespit etmeniz gerekir. Ancak bu hatların nerelerden geçtiğini tam olarak bildiğinizde yüksek maliyetli hasarları veya ölümcül kazaları önleyebilirsiniz.
- (HR) Prije nego što posegnete za bušilicom, trebali bi prije svega potražiti gdje na zidu prolaze vodovi za struju, vodu i plin. Samo ako Vi znate sigurno gdje prolaze vodovi, možete izbjeći troškove posljedica kao i svakako po život opasne nesreće.
- (NL/BL) Voordat u naar de boormachine grijpt, moet u altijd eest de elektriciteits-, water- en gasleidingen in de muur opsporen. Alleen als u precies weet waar de leidingen lopen, kunt u schade met hoge bijkomende kosten of zelfs levensbedreigende ongelukken voorkomen.
- (RO) Înainte de a apuca bormașina, trebuie să căutați în perete în fiecare caz în parte dacă există conducte de energie electrică, apă și gaz. Doar dacă știți cu exactitate traseele conductelor, puteți evita deteriorările cu costuri ulterioare ridicate sau chiar și accidentele fatale.
- (DK) Inden du griber til boremaskinen, bør du i alle tilfælde undersøge væggen for strøm, vand- og gasledninger. Kun hvis du nøjagtigt ved, hvor ledningerne løber, kan du undgå skader med store følgeomkostninger eller endda livsfarlige ulykker.
- (PT) Antes de pegar no berbequim, deve, de qualquer modo, verificar se existem linhas de corrente, água e gás na parede. Só se souber com precisão onde as linhas correm, pode evitar danificações com custos consecutivos elevados ou mesmo acidentes muito perigosos.
- (SE) Innan du börjar borra, ska du alltid undersöka om det finns el-, vatten- och gasledning i väggen. Det är bara när du exakt vet var sådana ledningar finns, som du kan undvika skador med höga kostnader som följd och – till och med – dödsolyckor.

12

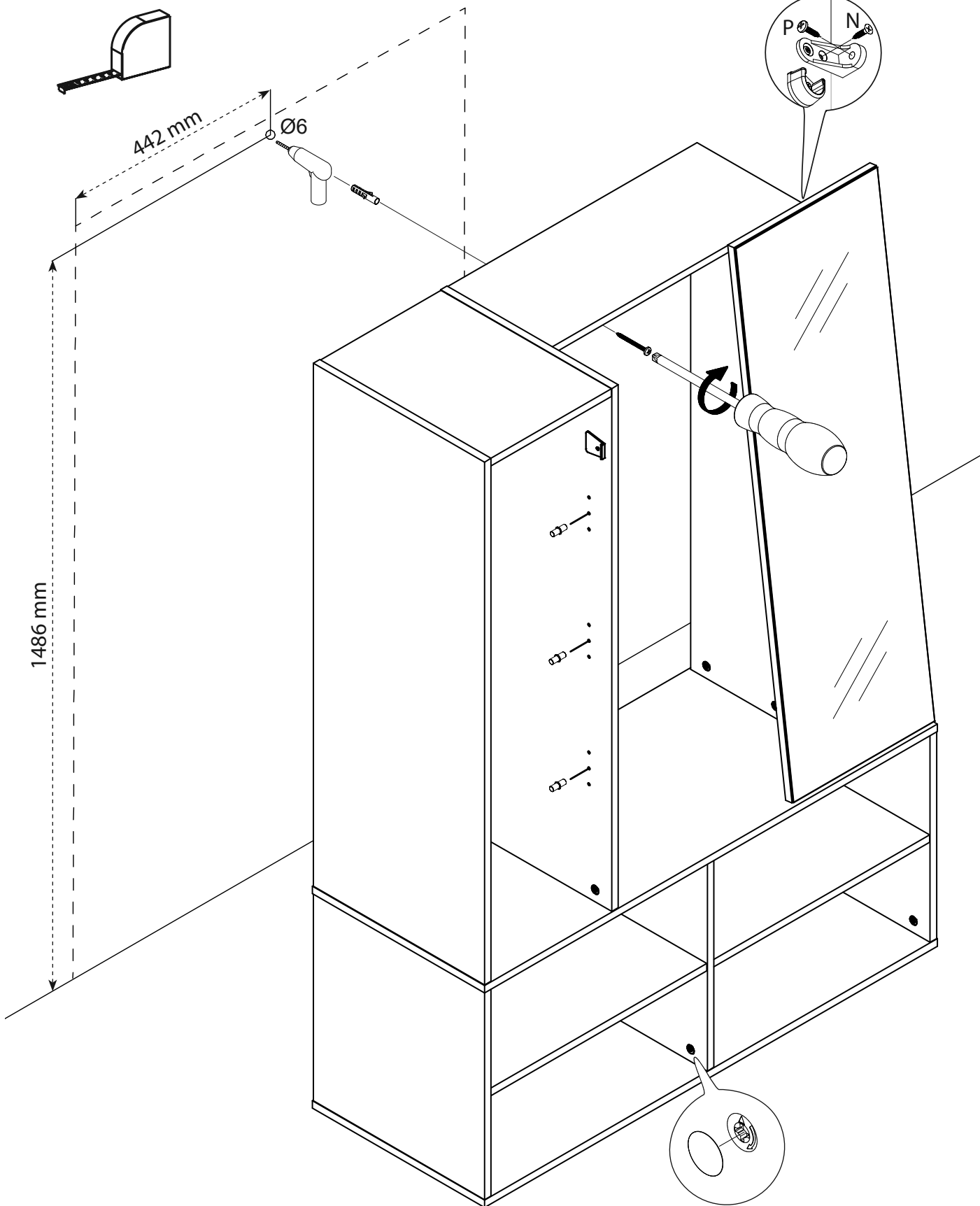
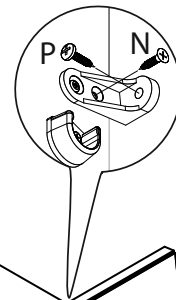
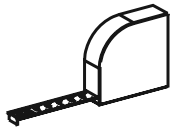
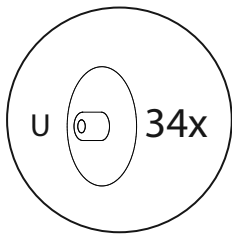
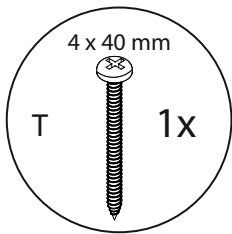
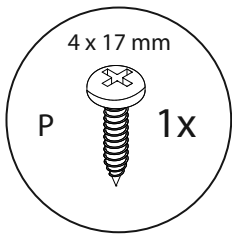
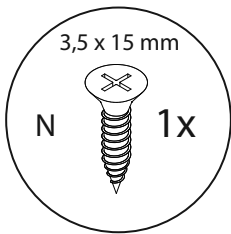
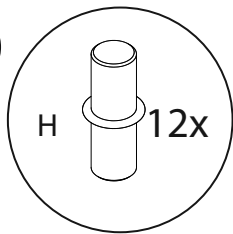

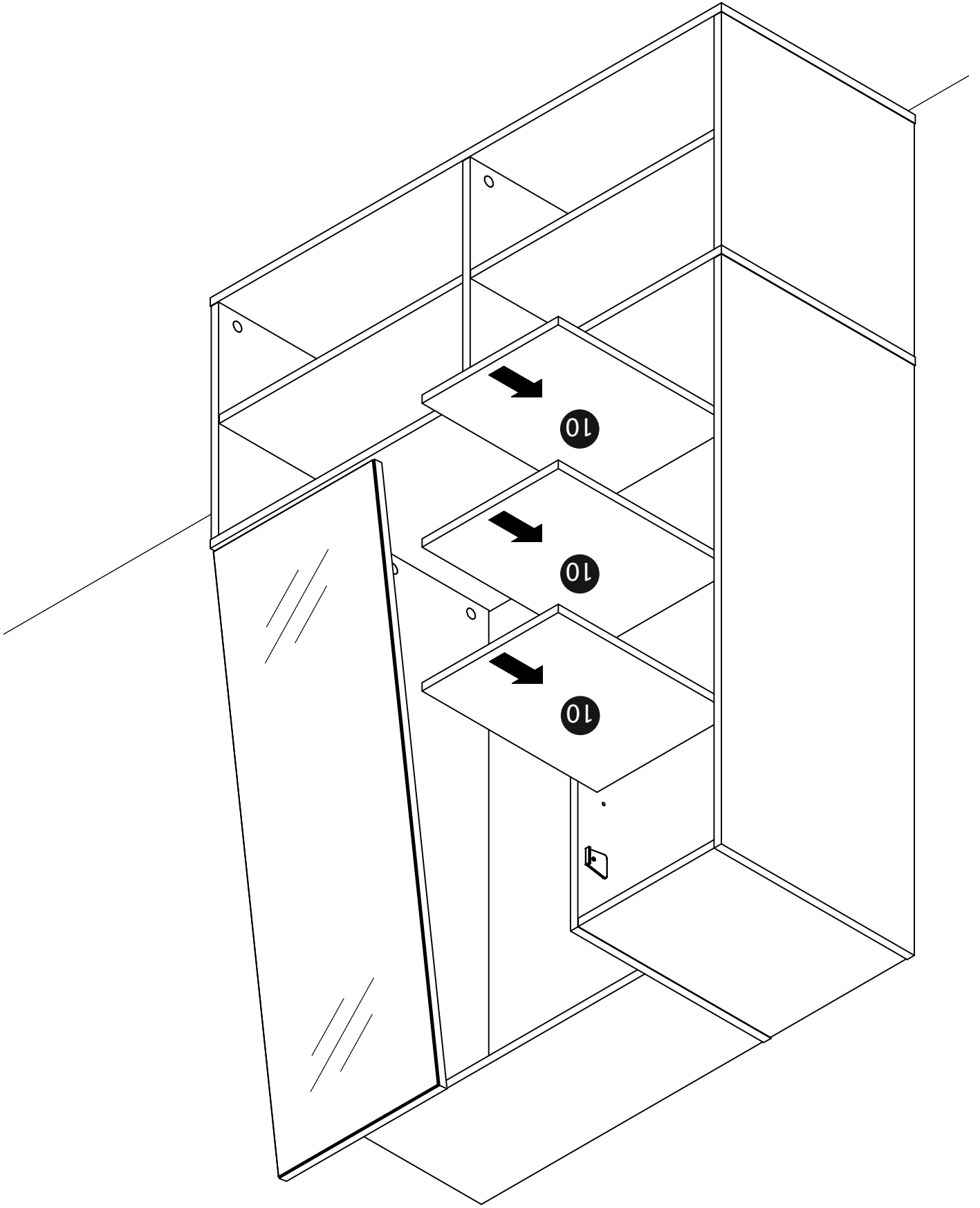

14

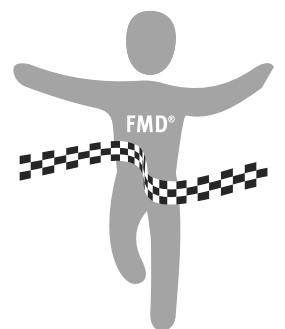
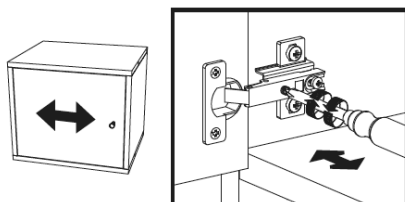
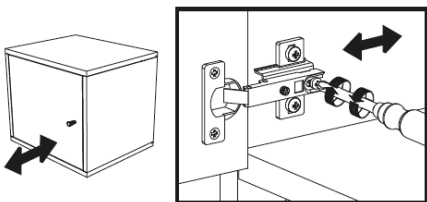
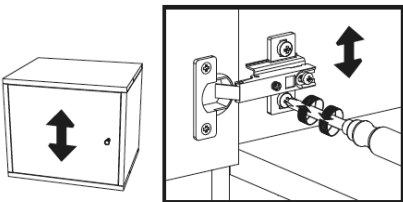
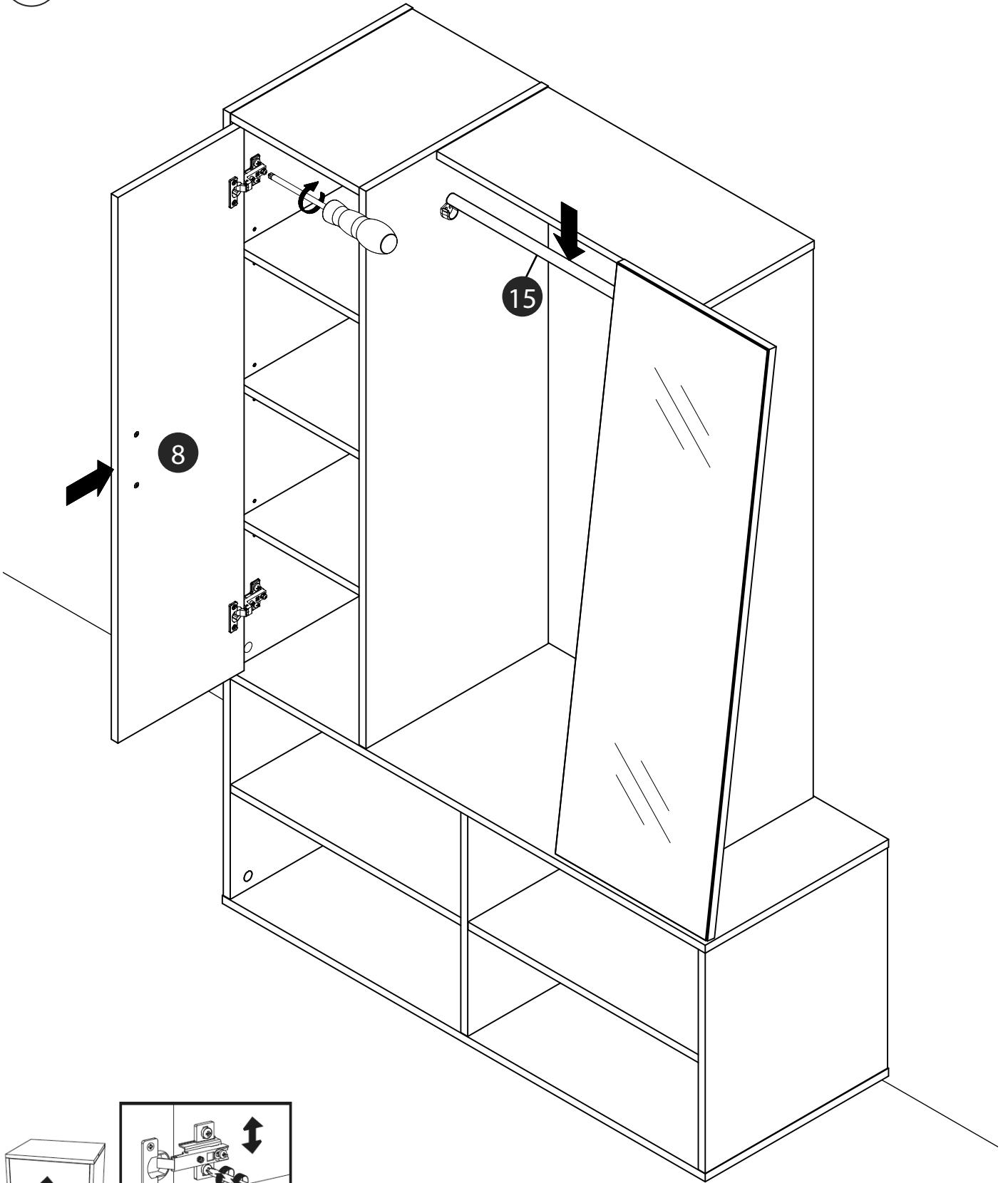

FMD Möbel GmbH

Heidländer Weg 68
D-49201 Dissen a.T.W.

Tel. +49 5421 9448-44
Fax +49 5421 9448-41

service@fmd-moebel.de
www.fmd-moebel.de