

>>STICKS/5-33<<

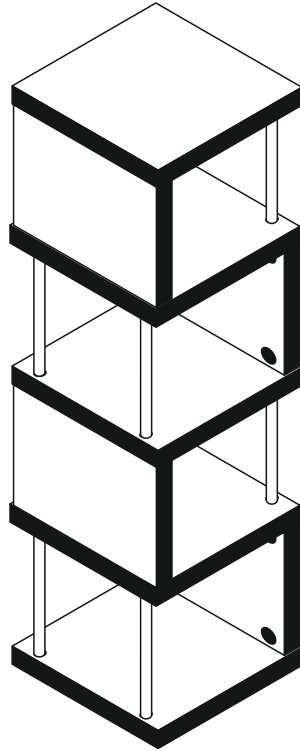

D Montageanleitung

GB Assembly instructions

FR Notice de montage

TR Montaj talimatı

IT Istruzioni di montaggio

NL Handleiding voor de montage

RU Инструкция по монтажу

CZ Montážní návod

HU Szerelési útmutató

RO Instrucțiuni de montaj

PL Instrukcja montażu

SK Návod na montáž

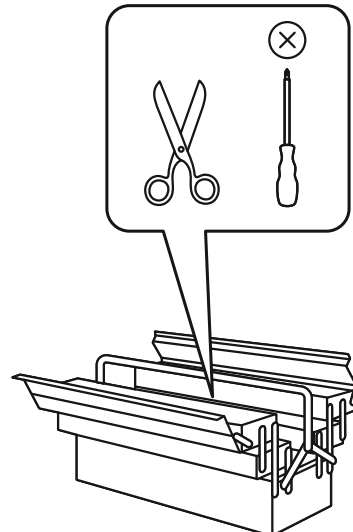
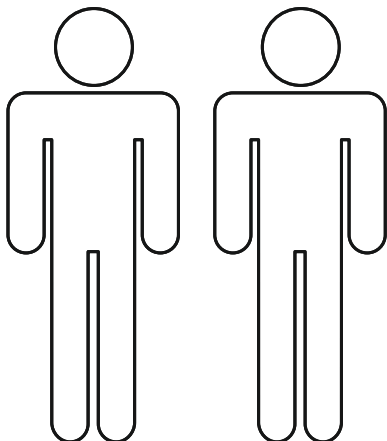

Service • Assistenza • Dienstverlening • Serwis Servis • Szerviz • Сервисная служба

Name • Nom • Nome • Naam • Nazwa • Jméno •
Názov • Név • Denumire • Isim • Название





Sticks/5-33

Nr. • No. • N° • Номер • Č • Sz

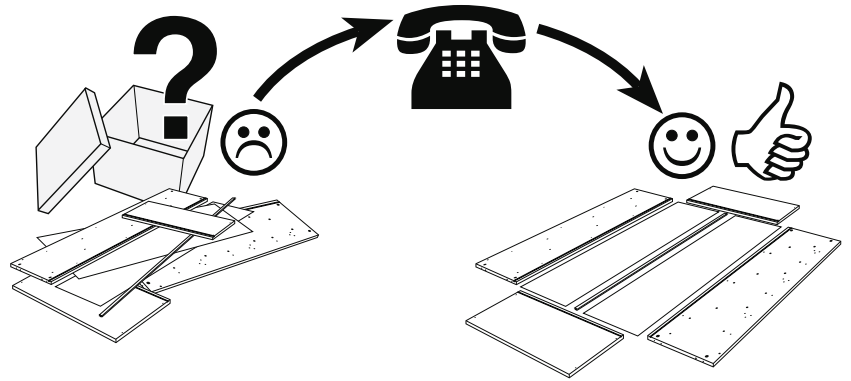
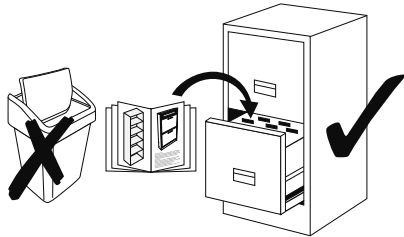
0511_00

Typ • Type • Tip • Típus • Тіро • Тип

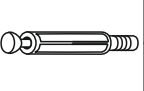

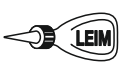
1-90 4x	 3,5x20	2-10 16x		2-20 16x		2-170 4x	
5-130 2x							

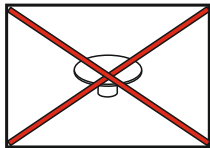
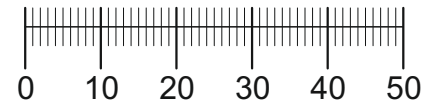

Artikel enthält keine
Abdeckkappen für
Excenter (Teil 2-10)!

