

# TORINO

3 sitzer Sofa

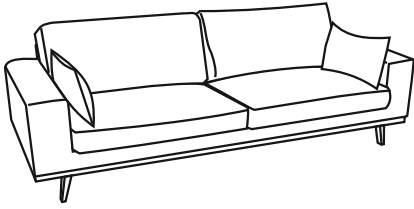

20 min

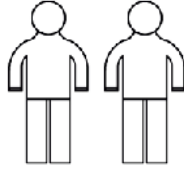

- |                                  |                              |
|----------------------------------|------------------------------|
| (D) Montageanleitung             | (GB) Assembly instructions   |
| (FR) Notice de montage           | (IT) Istruzioni di montaggio |
| (NL) Handleiding voor de montage | (PL) Instrukcja montażu      |
| (CZ) Montážní návod              | (SK) Návod na montáž         |
| (HU) Szerelési útmutató          | (RO) Instrucțiuni de montaj  |
| (TR) Montaj talimatı             | (RU) Инструкция по монтажу   |

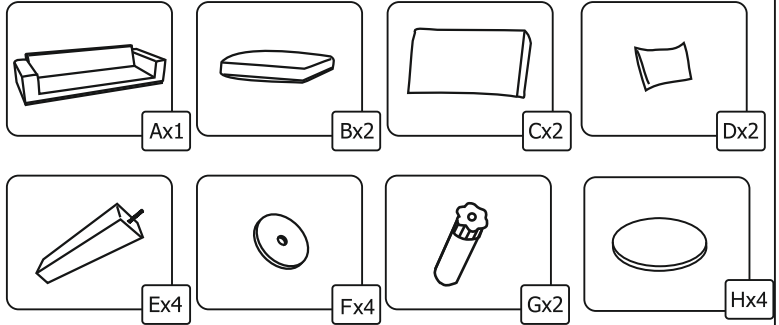
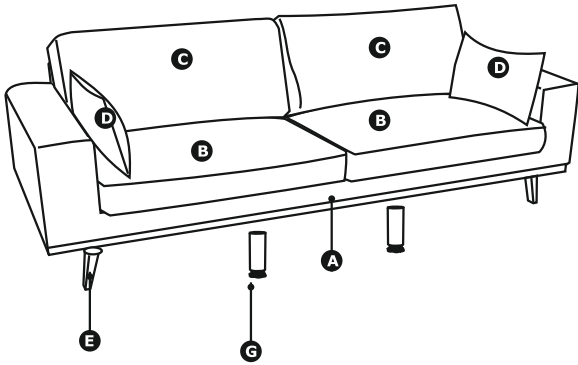

1

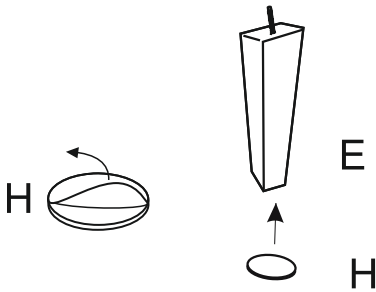

2

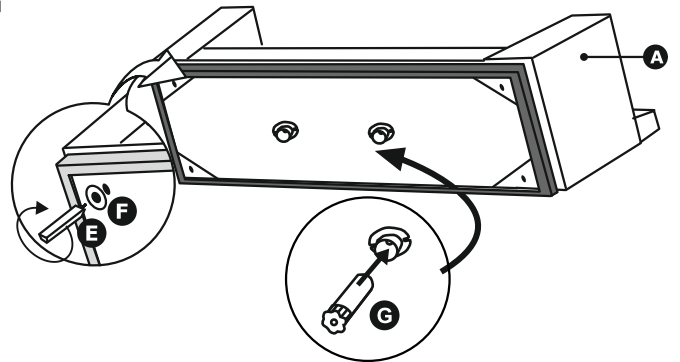

3

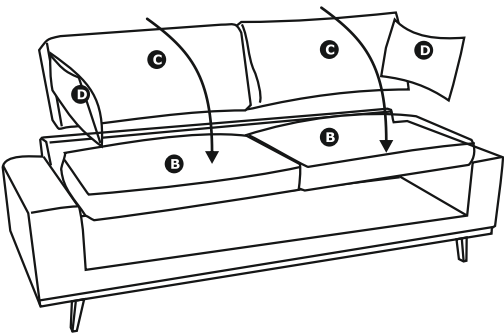

4

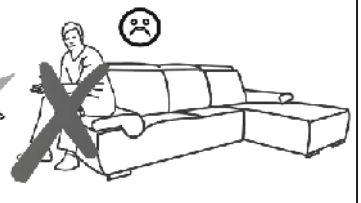
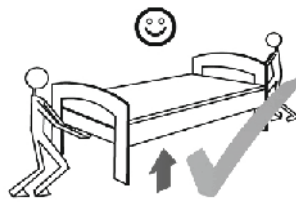
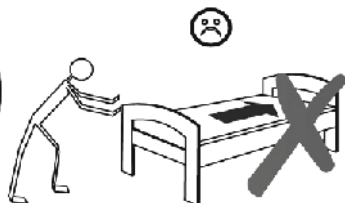
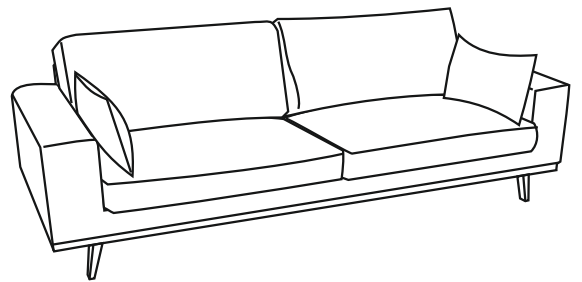

**Service • Assistenza • Dienstverlening • Serwis  
Servis • Szerviz • Сервисная служба**

|   |                          |
|---|--------------------------|
| Name • Nom • Nome • Naam •<br>Nazwa • Jméno • Názov • Név •<br>Denumire • Isim • Название | <b>TORINO</b>            |
| Nr • No. • N° • Номер • Č • Sz  |                          |
| Typ • Type • Тип • Tipus • Tipo •<br>Тип  | <b>3 SITZER<br/>SOFA</b> |
|   |                          |

