

GIZEH V

8241-0064/2500-0037-0064/8300-0064
8100-0064/2500-0037-0064/8242-0064

F

201101

- | | | | |
|-----------|--|-----------|---|
| D | MONTAGEANLEITUNG
BEDIENUNGSANLEITUNG | GB | ASSEMBLY INSTRUCTIONS
INSTRUCTION MANUAL |
| NL | HANDLEIDING VOOR DE MONTAGE
GEBRUIKSAANWIJZING | PL | INSTRUKCJA MONTAŻU
INSTRUKCJA OBSŁUGI |
| TR | MONTAJ TALIMATI
KULLANIM KLAVUZU | RU | ИНСТРУКЦИЯ ПО МОНТАЖУ
ИНСТРУКЦИЯ ПО ЭКСПЛУАТАЦИИ |
| RO | INSTRUCȚIUNI DE INSTALARE
INSTRUCȚIUNI DE UTILIZARE | IT | ISTRUZIONI DI MONTAGGIO
MANUALE DI ISTRUZIONI |
| FR | NOTICE DE MONTAGE
MANUEL INSTRUCTIONS | SK | MONTÁŽNY NÁVOD
NÁVOD NA POUŽITIE |
| HU | KÖZGYŰLÉS UTASÍTÁSOK
KEZELÉSI UTASÍTÁS | CZ | MONTÁŽNÍ NÁVOD
NÁVOD K POUŽITÍ |
| SI | NAVODILA ZA MONTAŽO
NAVODILA ZA UPORABO | PT | INSTRUÇÕES DE MONTAGEM
MANUAL DO USUÁRIO |
| ES | INSTRUCCIONES DE MONTAJE
MANUAL DEL USUARIO | HR | UPUTE ZA MONTAŽU
UPUTE ZA UPOTREBU |

R

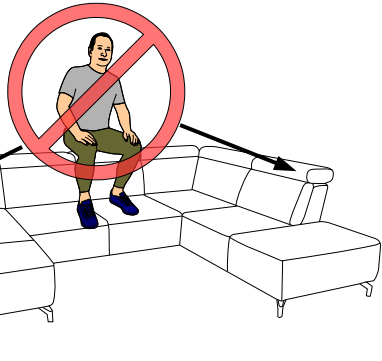

L

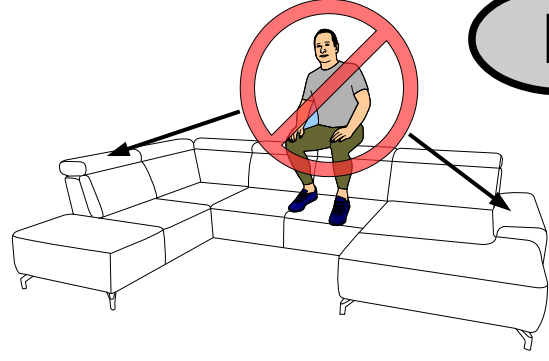

y_{H-120/150} X1	z_{H(120-180)} X2	q M6*25 X12	i L-4 X1	x_{H-120/150} [mm] X3
--	---	---------------------------	------------------------	---

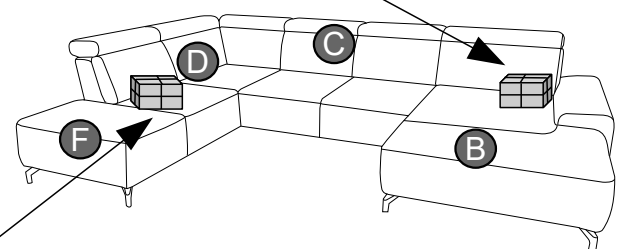
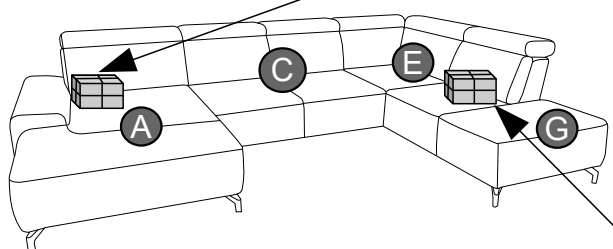

y_{H-120/150} X1	z_{H(120-180)} X3	q M6*25 X12	i L-4 X1	x_{H-120/150} X3
--	---	---------------------------	------------------------	--

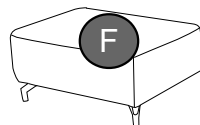
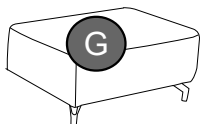
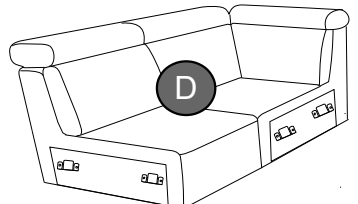
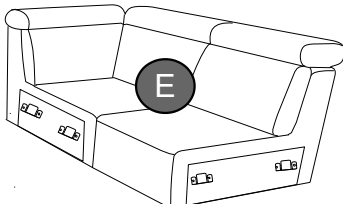
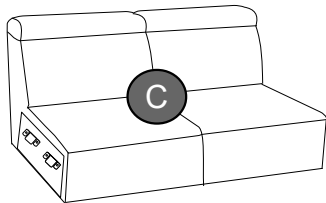
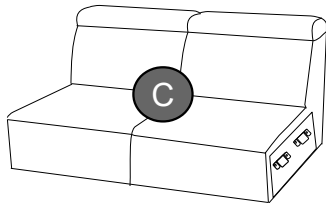
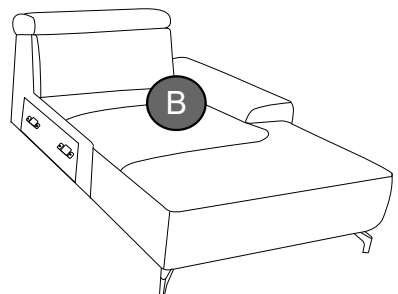
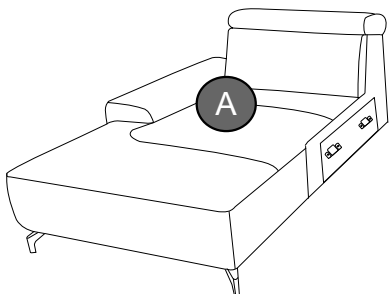

y_{H-120/150} 	z_{H(120-180)} 	x_{H-120/150} 	q M6*25 	i L-4
X2	X5	X6	X24	X1

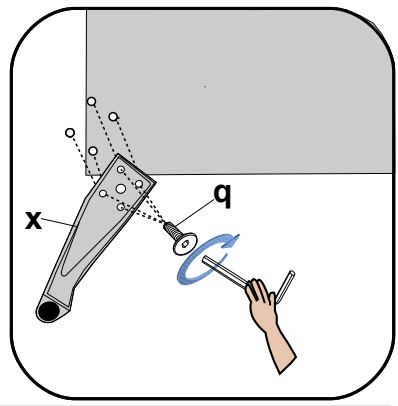
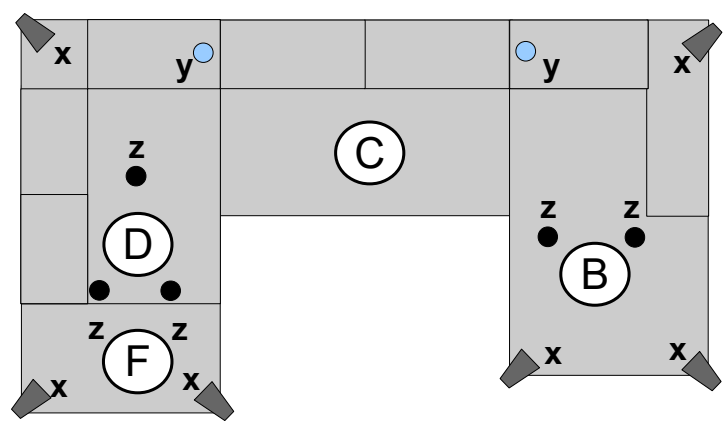
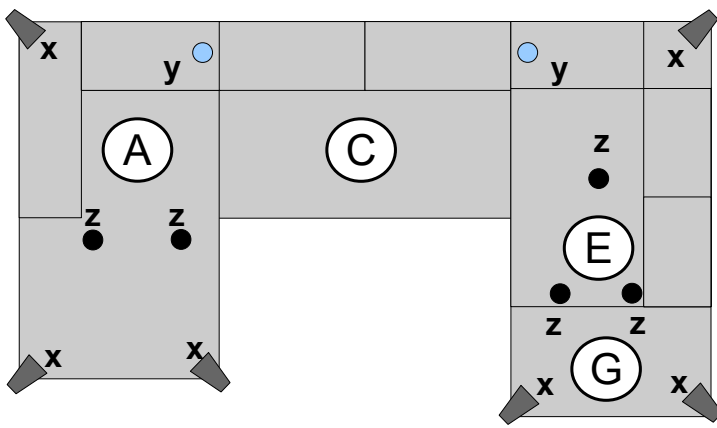
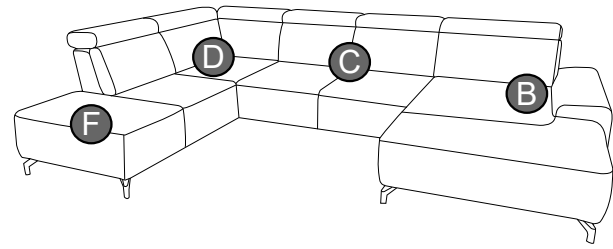
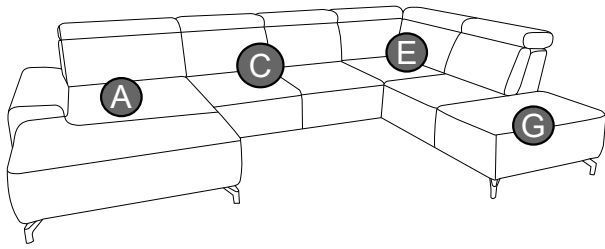

Z

120/150

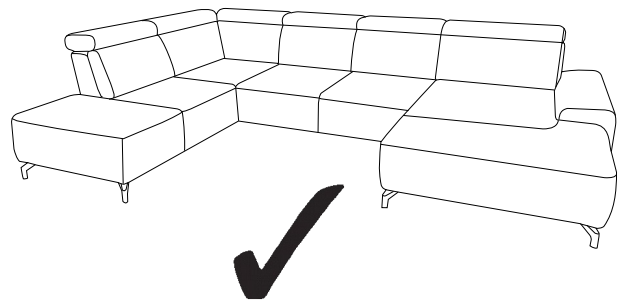
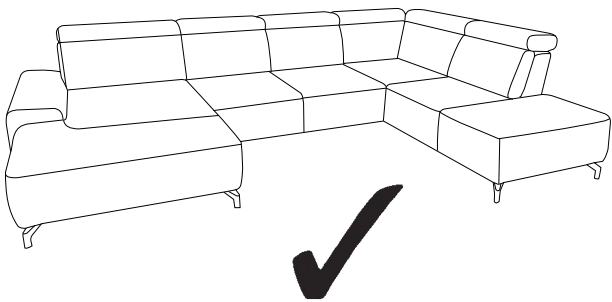
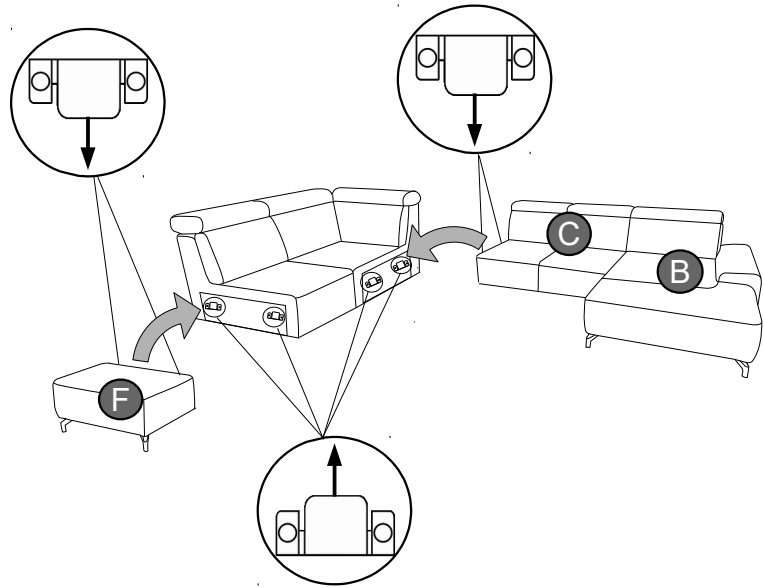
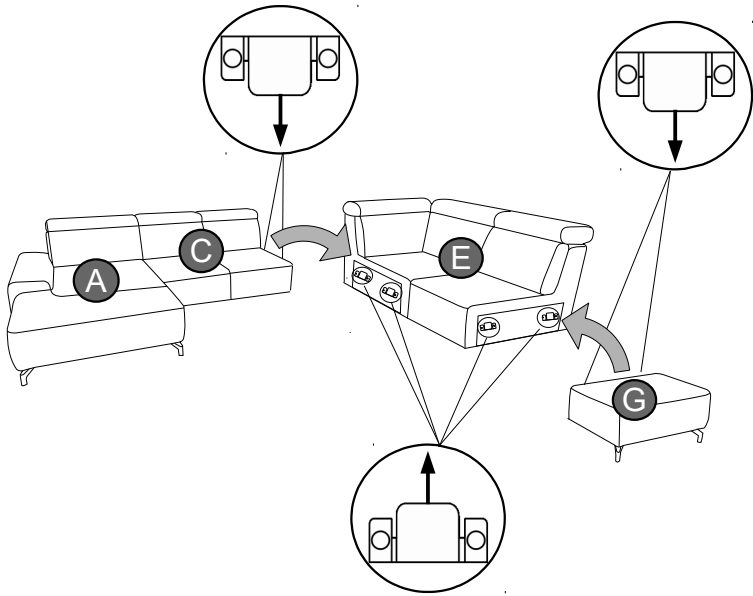
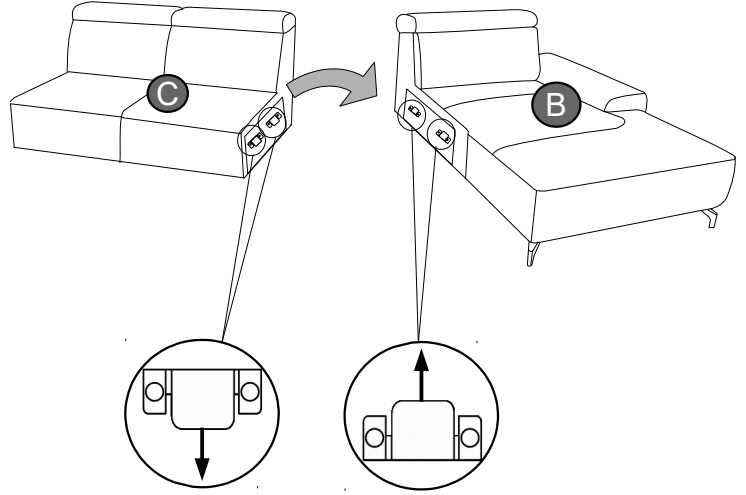
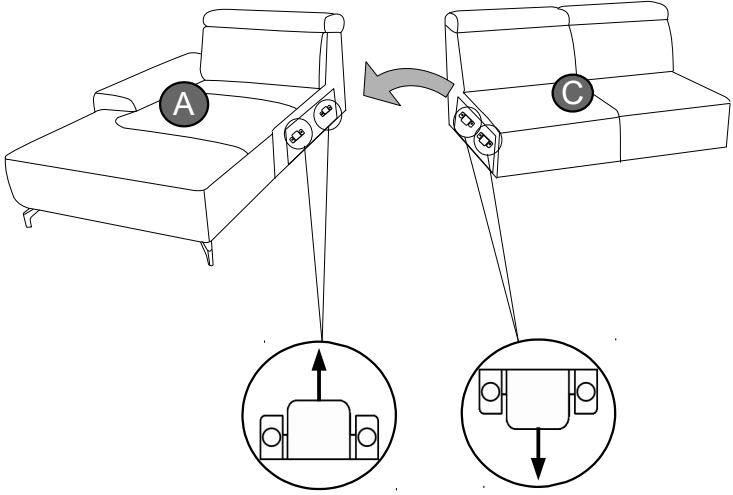
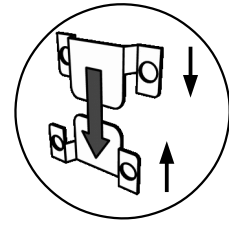
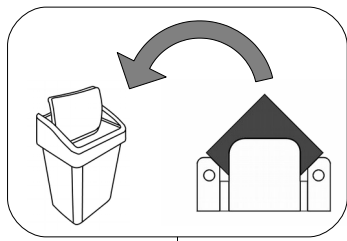
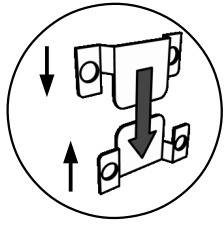

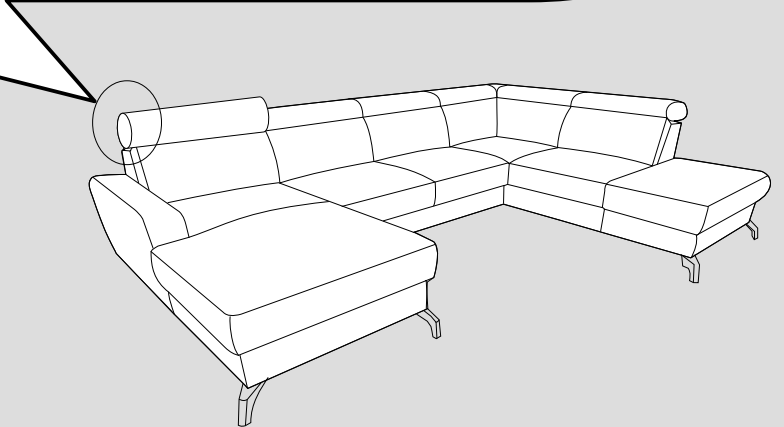
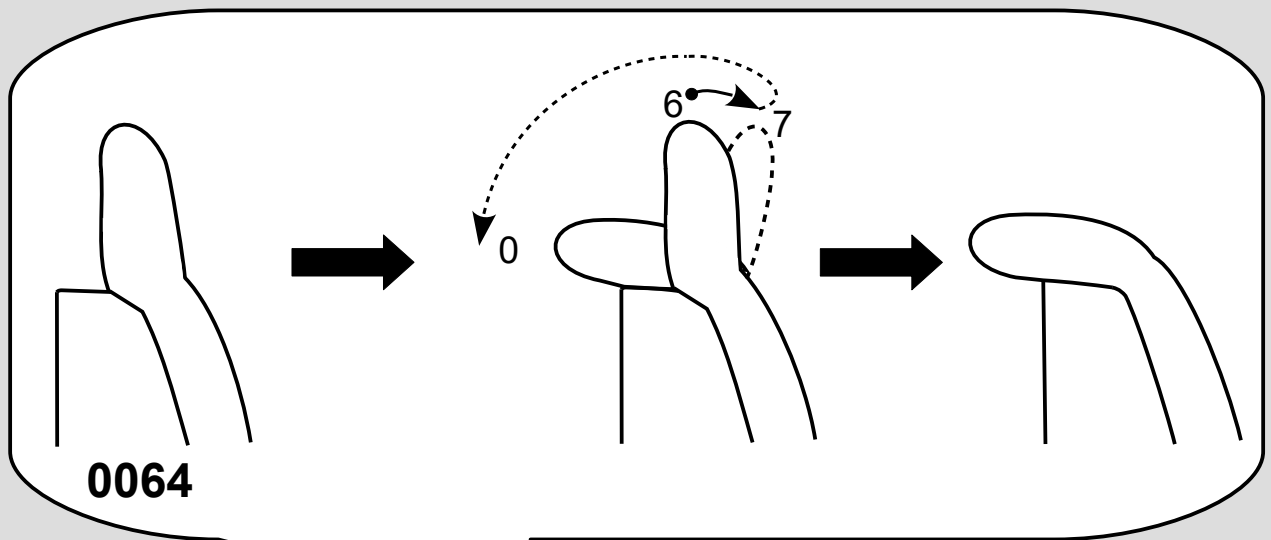
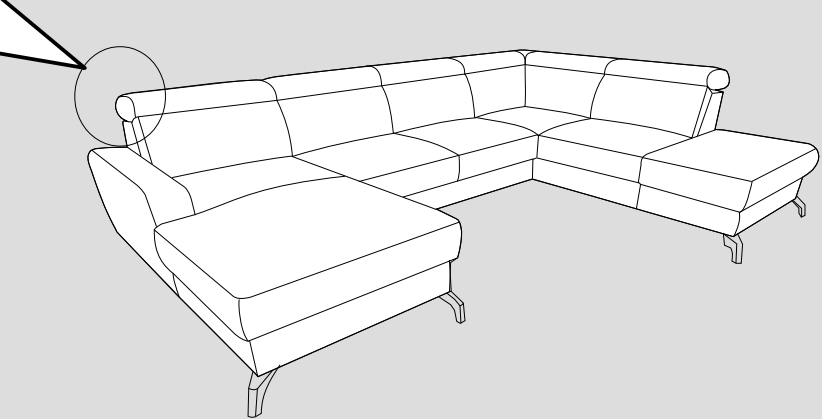
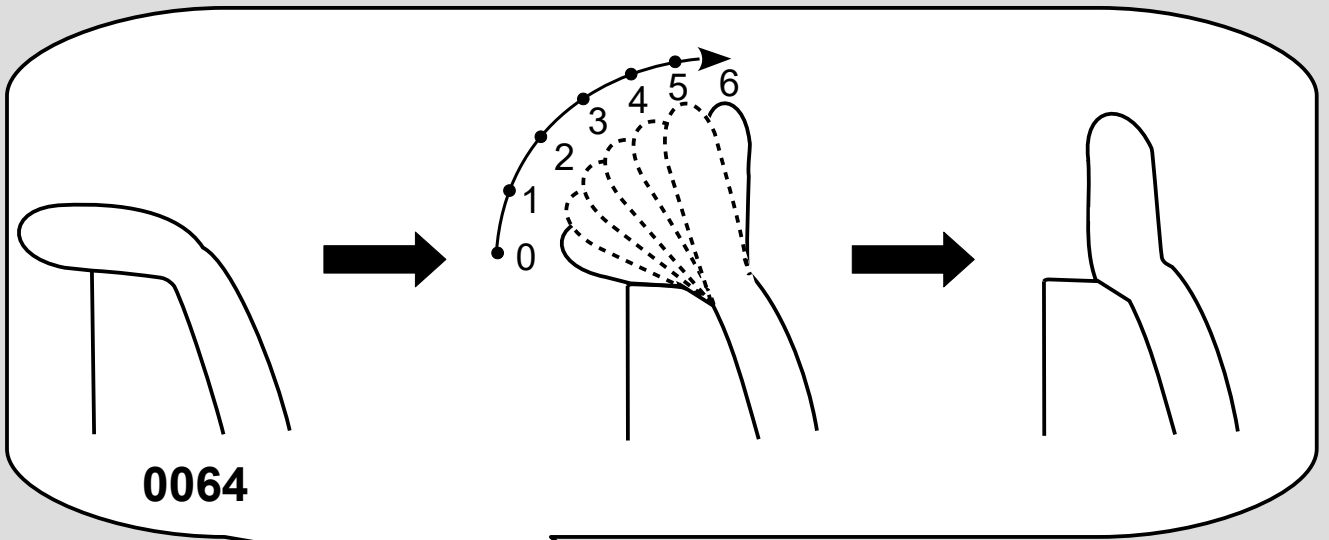

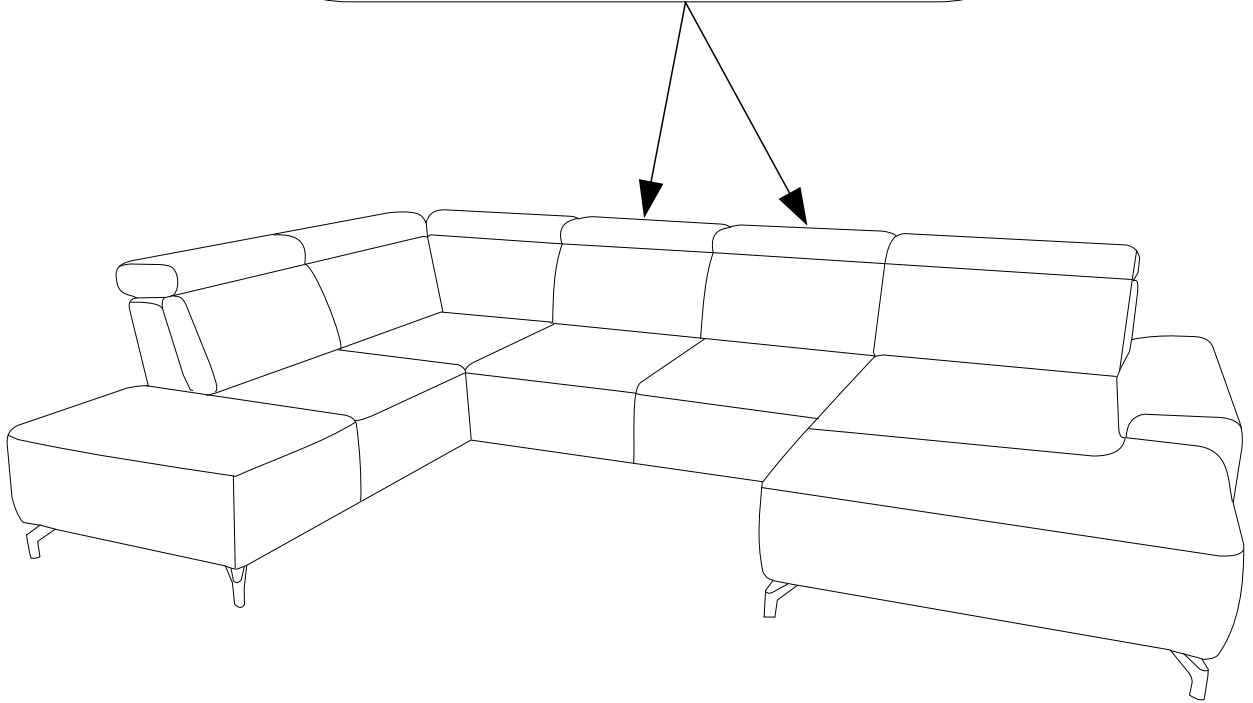
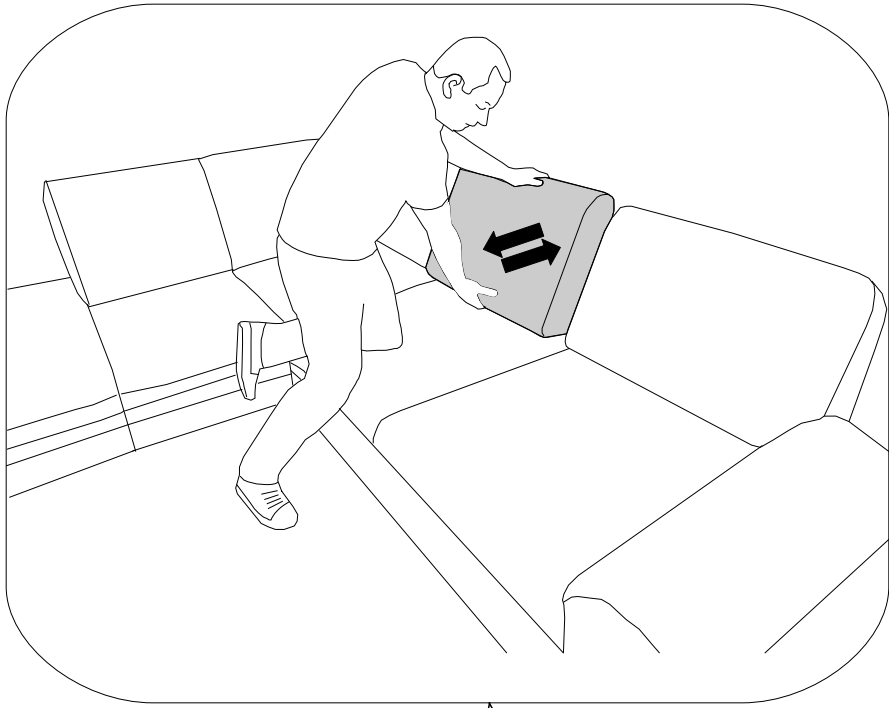

Name · Naam · Nazwa · İsim · Название · Nume · Nome · Název · Názov ·
 Název · Neve

GIZEH V

Typ · Type · Tip · Тип · Tipo · Típus

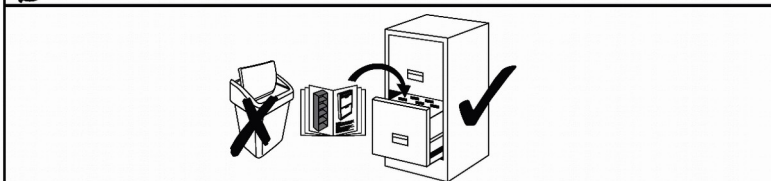
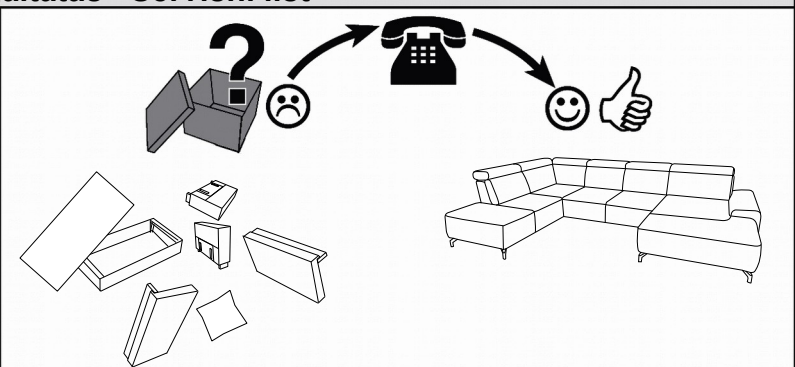

R

L

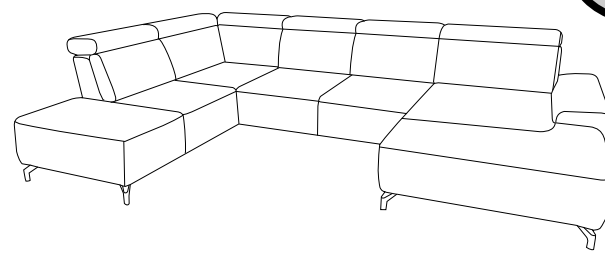
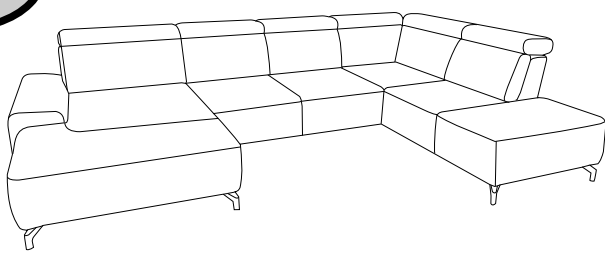

y H-120/150 	Z H(120-180) 	x H-120/150 	q M6*25 	i L-4 [mm]
------------------------	-------------------------	------------------------	--------------------	-----------------------

