

- (D) AUFBAUANLEITUNG
- (NL) HANDLEIDING VOOR DE MONTAGE
- (TR) MONTAJ TALIMATI
- (RO) INSTRUCIUNI DE ASAMBLARE
- (F) INSTRUCTION D'ASSEMBLAGE
- (CZ) POKYNY K MONTÁŽI

- (GB) ASSEMBLY INSTRUCTIONS
- (PL) INSTRUKCJA MONTAŻU
- (RU) Инструкция по монтажу
- (I) PROCEDURA DI ASSEMBLAGGIO
- (SK) POKYNY K MONTÁŽI
- (HU) KÖZGYŰLÉS UTASÍTÁSOK

“CHEF” 2F-OTM/BK

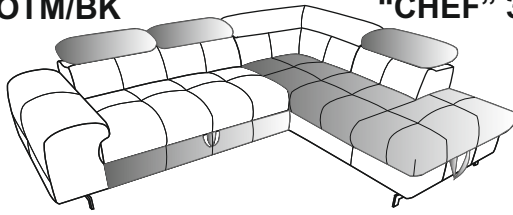

“CHEF” 3ER; 2ER

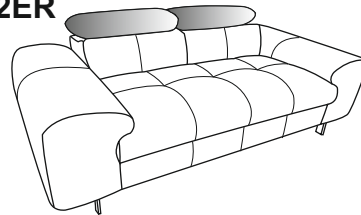

“CHEF” HOCKER

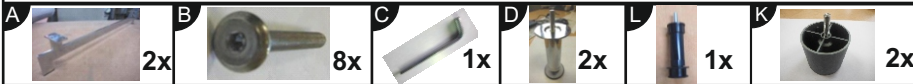
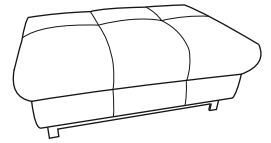

“CHEF” 2F-OTM/BK

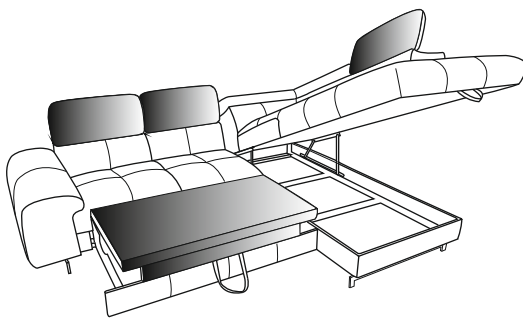
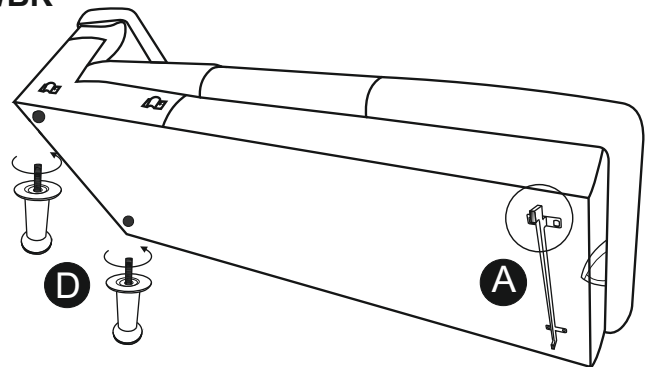
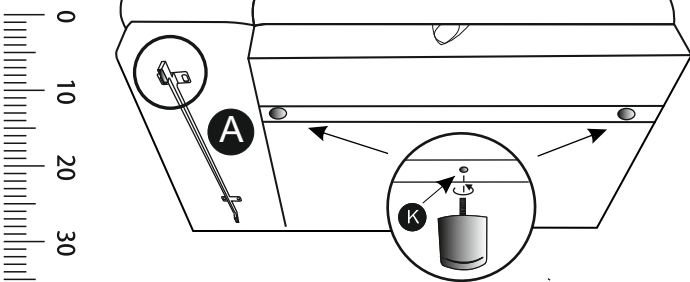

“CHEF” 3ER; 2ER

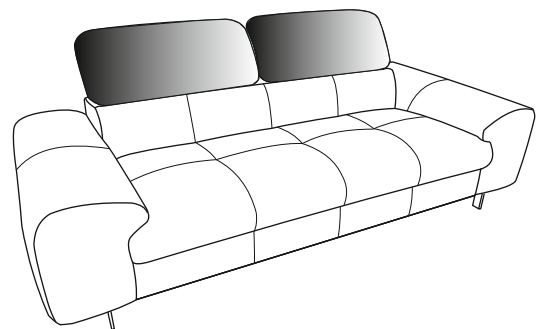

“CHEF” HOCKER

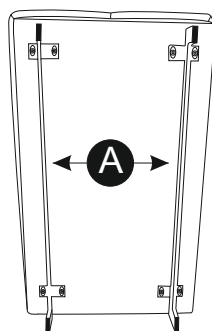
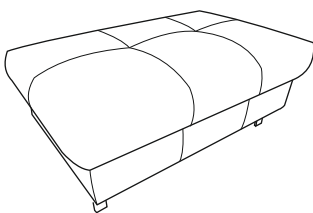

“CHEF” 3ER

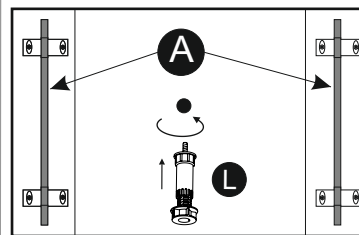

“CHEF” 2ER

