

# SAMSO

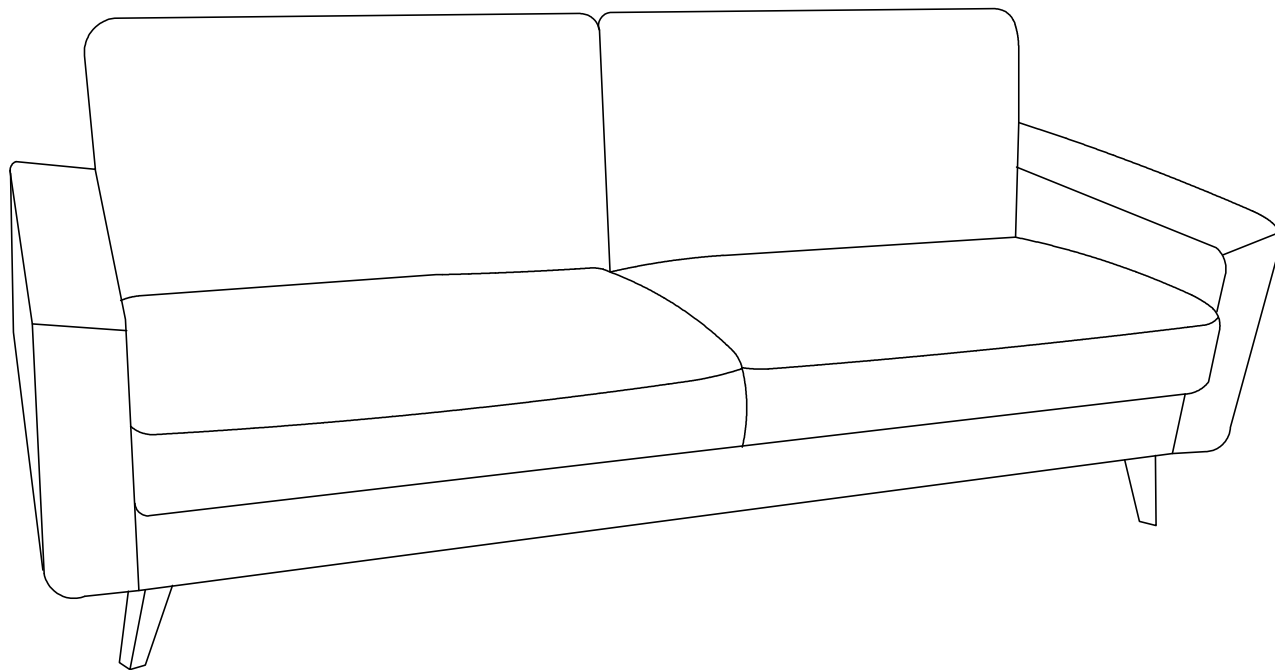

x 2



PL

INSTRUKCJA MONTAŻU  
INSTRUKCJA OBSŁUGI

GB

ASSEMBLY INSTRUCTIONS  
INSTRUCTION MANUAL

D

MONTAGEANLEITUNG  
BEDIENUNGSANLEITUNG

NL

HANDLEIDING VOOR DE MONTAGE  
GEBRUIKSAANWIJZING

TR

MONTAJ TALIMATI  
KULLANIM KLAVUZU

RU

ИНСТРУКЦИЯ ПО МОНТАЖУ  
ИНСТРУКЦИЯ ПО ЭКСПЛУАТАЦИИ

RO

INSTRUCȚIUNI DE INSTALARE  
INSTRUCȚIUNI DE UTILIZARE

IT

ISTRUZIONI DI MONTAGGIO  
MANUALE DI ISTRUZIONI

FR

NOTICE DE MONTAGE  
MANUEL INSTRUCTIONS

SK

MONTÁŽNY NÁVOD  
NÁVOD NA POUŽITIE





HU

SZERELÉSI ÚTMUTATÁS  
KEZELÉSI UTASÍTÁS

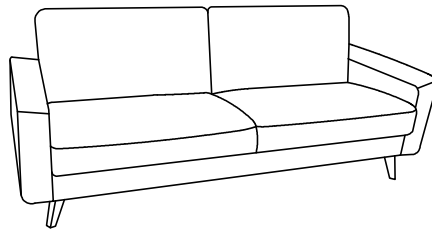
CZ

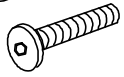
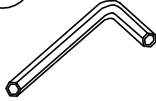
MONTÁŽNÍ NÁVOD  
NÁVOD K POUŽITÍ





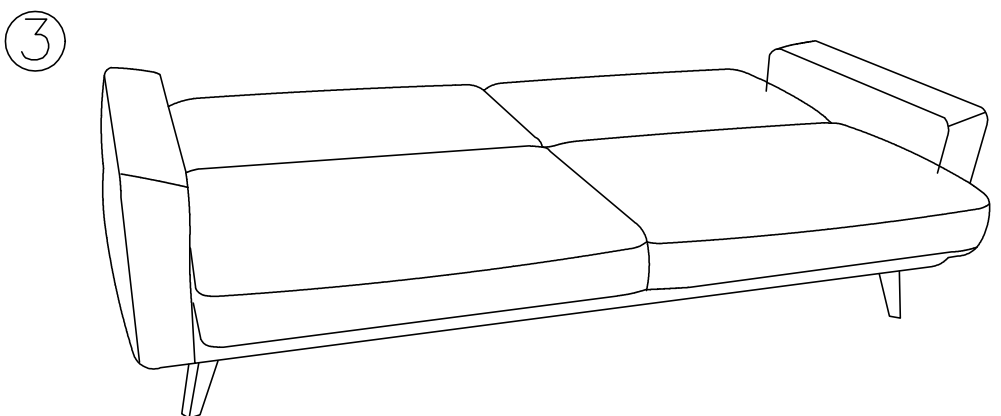
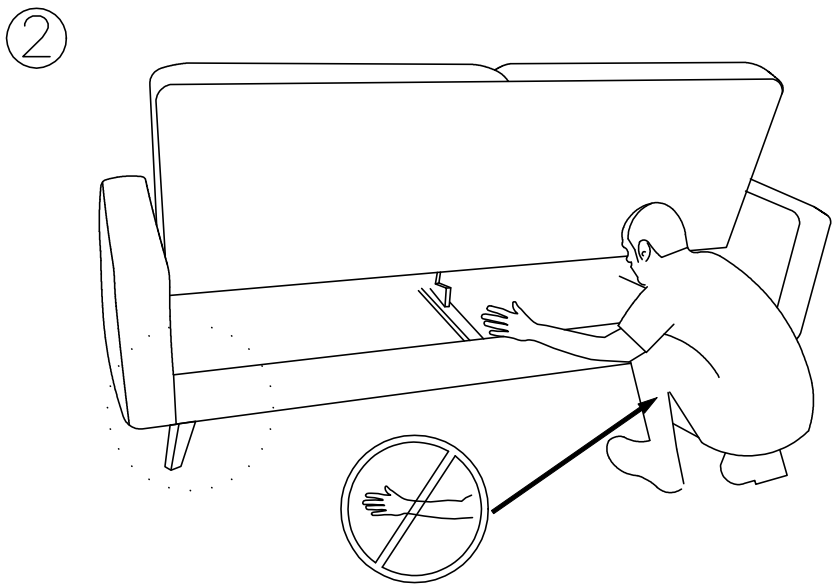
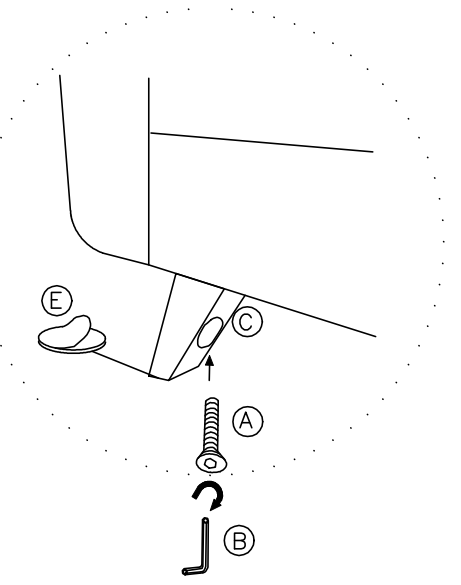
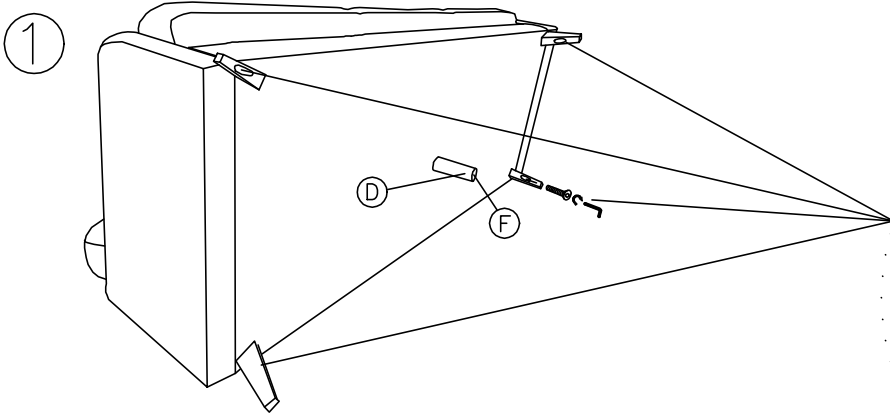

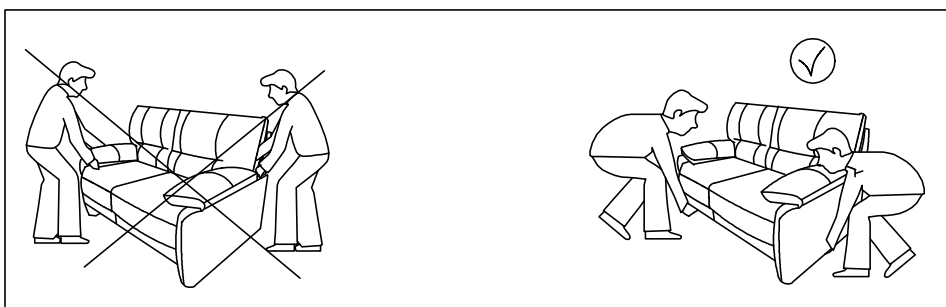
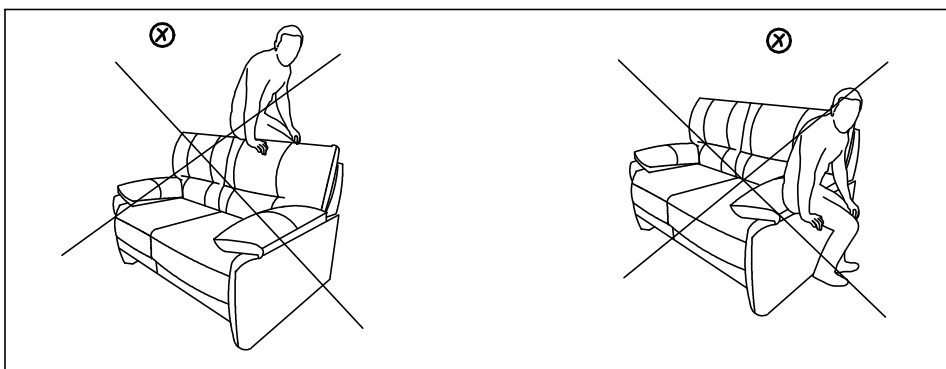
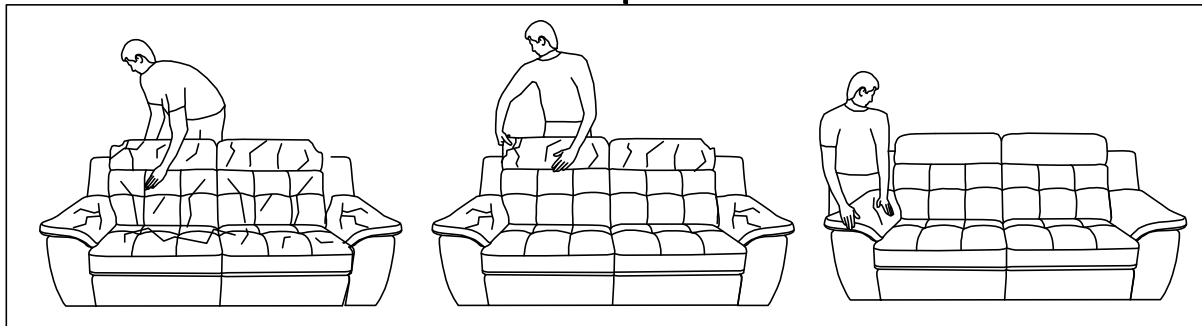
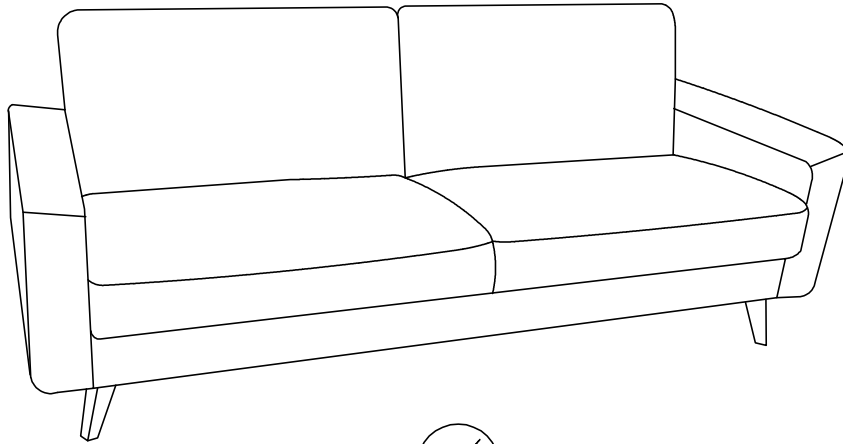
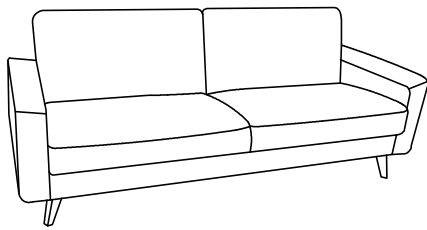

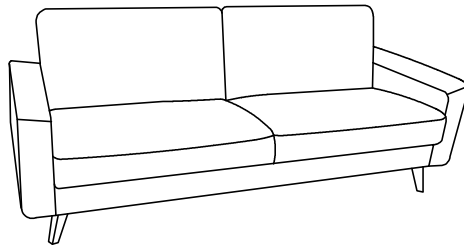

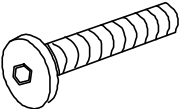
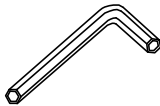

<b>A</b>  M8 x 60	<b>B</b> 	<b>C</b> 	<b>D</b>  15 150	<b>E</b>  ø20	<b>F</b>  ø40
x4	x1	x4	x1	x4	x1

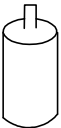



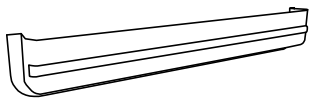
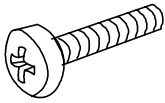

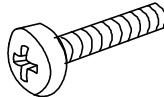
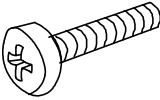
Service – Assistenza – Dienstverlening – Serwis – Сервисная служба  
Servis – Szerviz –

<p>(A)  M8 x 60 .....</p>	<p>(B)  .....</p>	<p>(C)  .....</p>
<p>(D)  h 150 .....</p>	<p>(E)  ø20 .....</p>	<p>(F)  ø40 .....</p>
<p>(G)  .....</p>	<p>(H)  .....</p>	<p>(I)  M6 x 60 .....</p>
<p>(J)  M6 .....</p>	<p>(K)  ø8 x 24 x 2 .....</p>	<p>(L)  M6 x 20 .....</p>
<p>(M)  M6 x 65 .....</p>	<p>(N)  .....</p>	