

980103

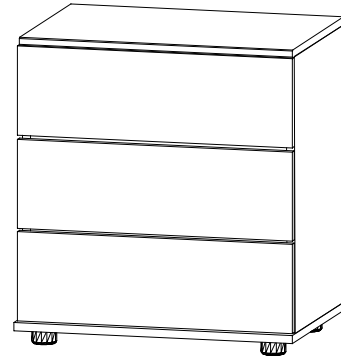

703

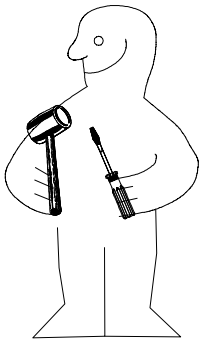
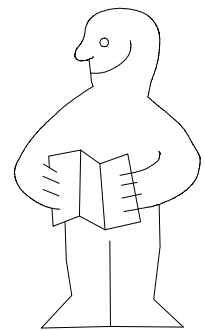
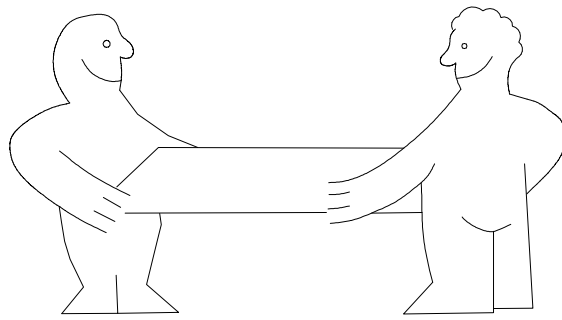
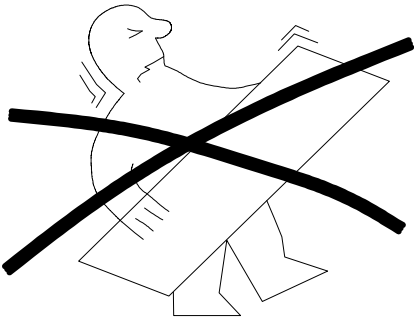

1-2-3-4... ○ ○

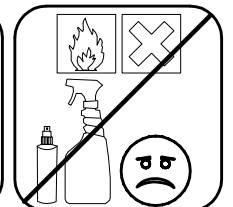
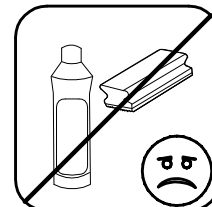
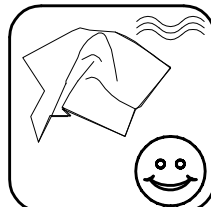
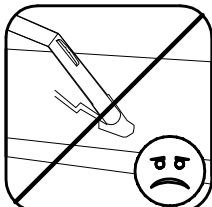
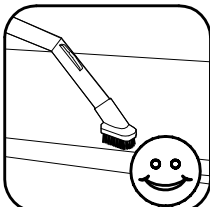
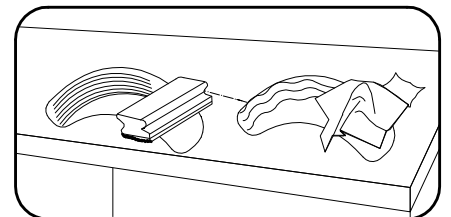
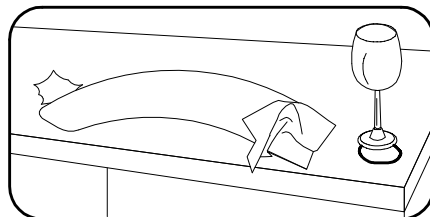
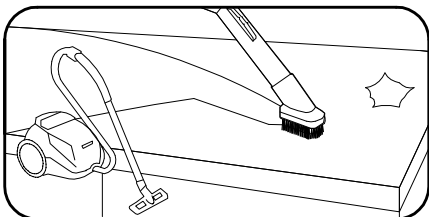
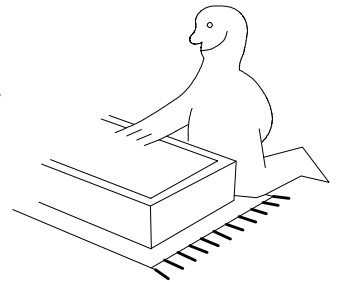
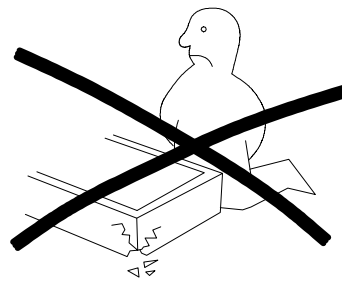
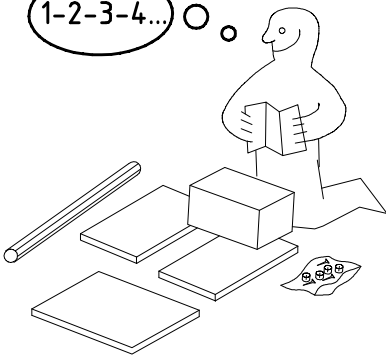

980103

19.05.14 / 06.08.24

08 24

1/8

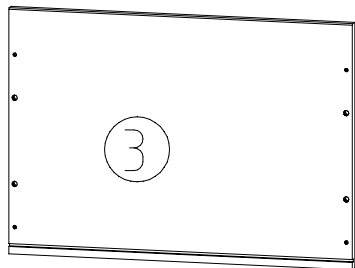
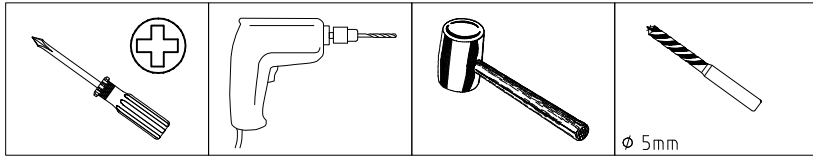
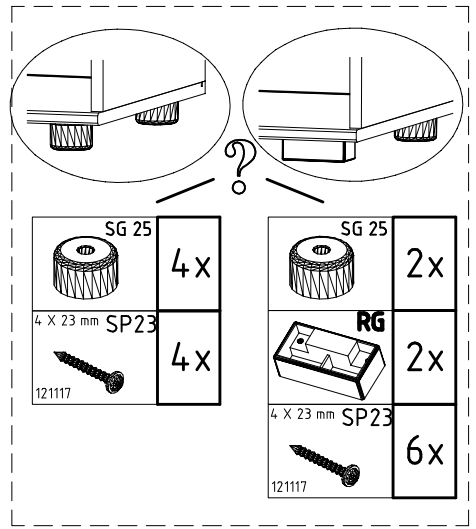
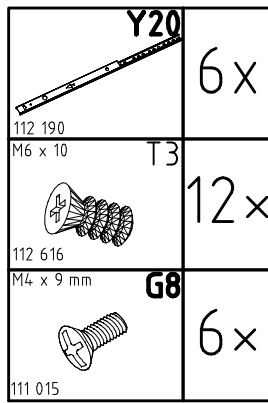
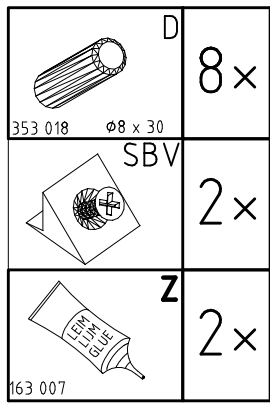
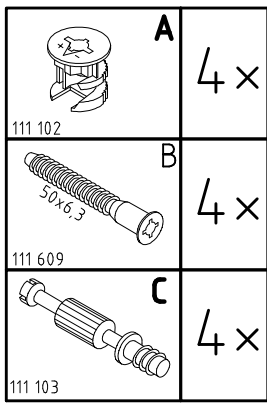

520x365x15

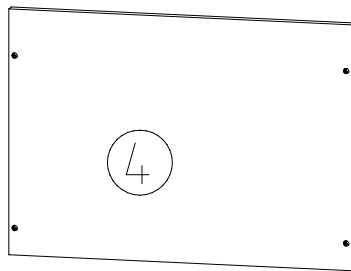

520x365x15

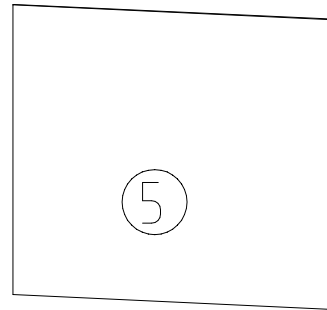

515x496x2,5

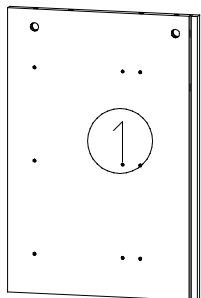

506x345x15

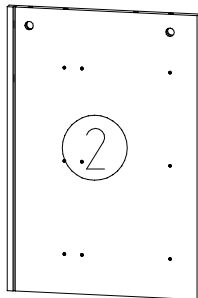

506x345x15

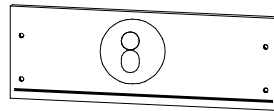

3x 513x163x15

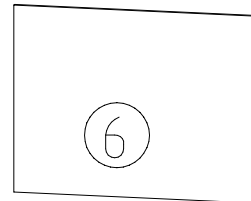

3x 465x315x2,5

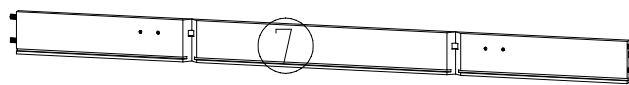
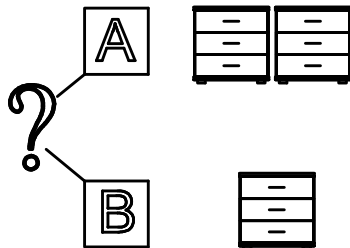
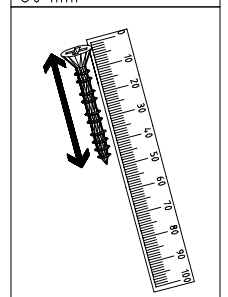
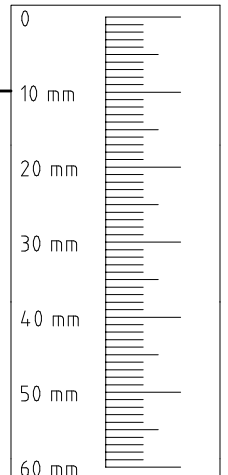

3x 316/480 / 316x75x12

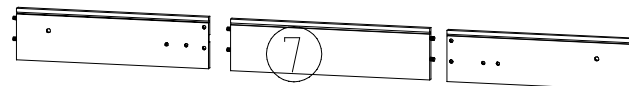

1

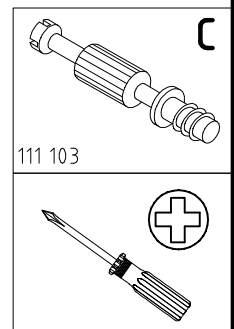
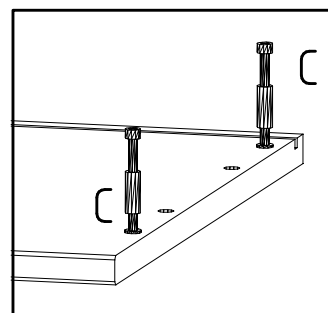
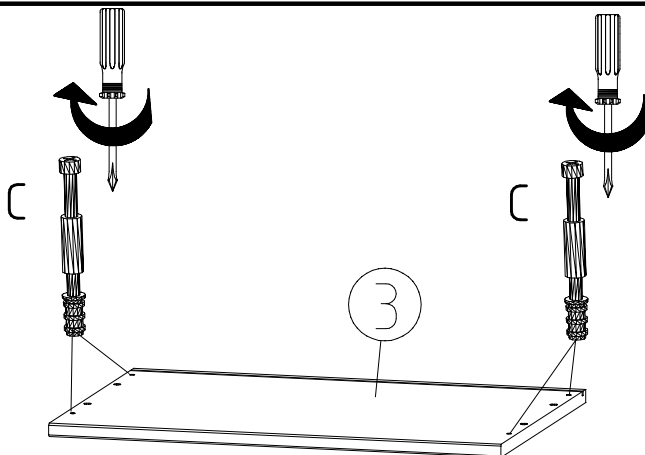

2

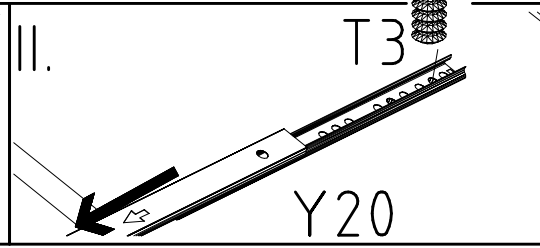
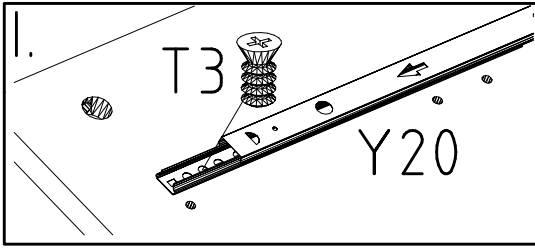
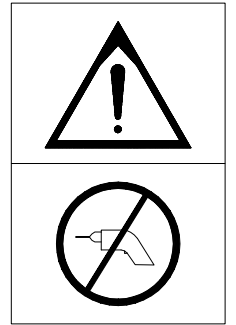
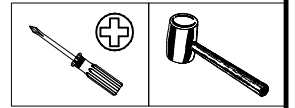
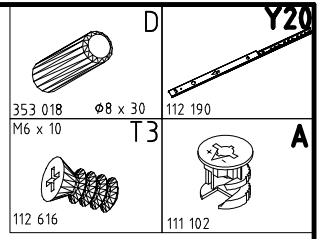
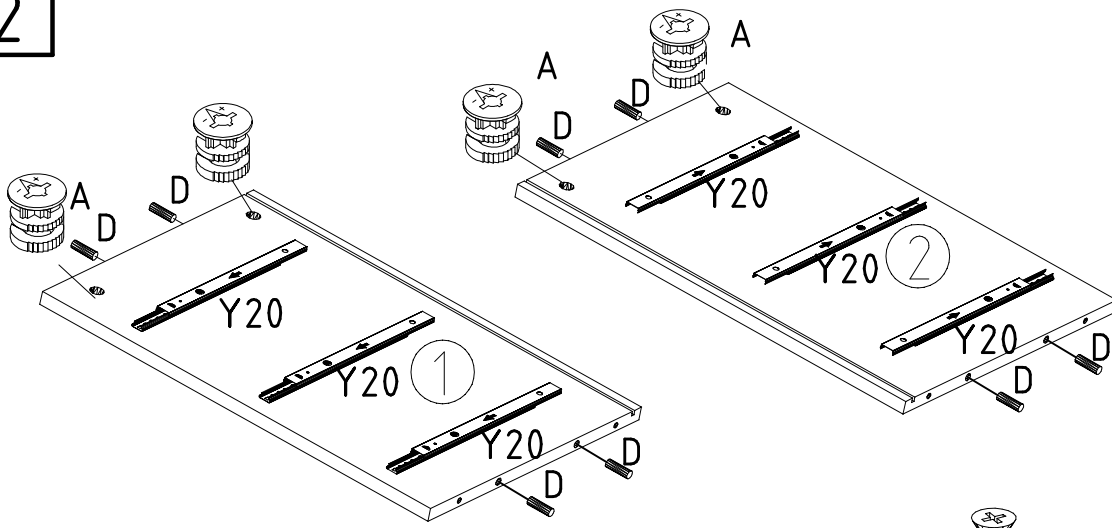

3

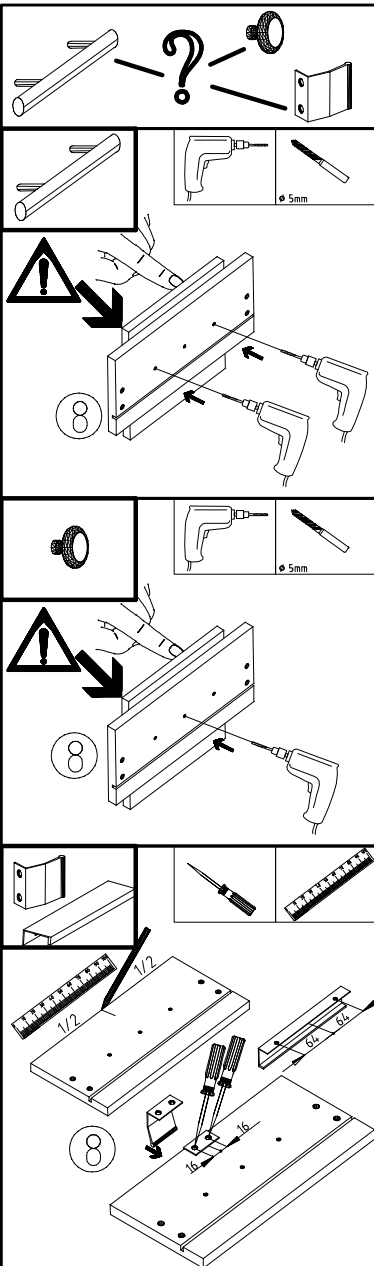

4

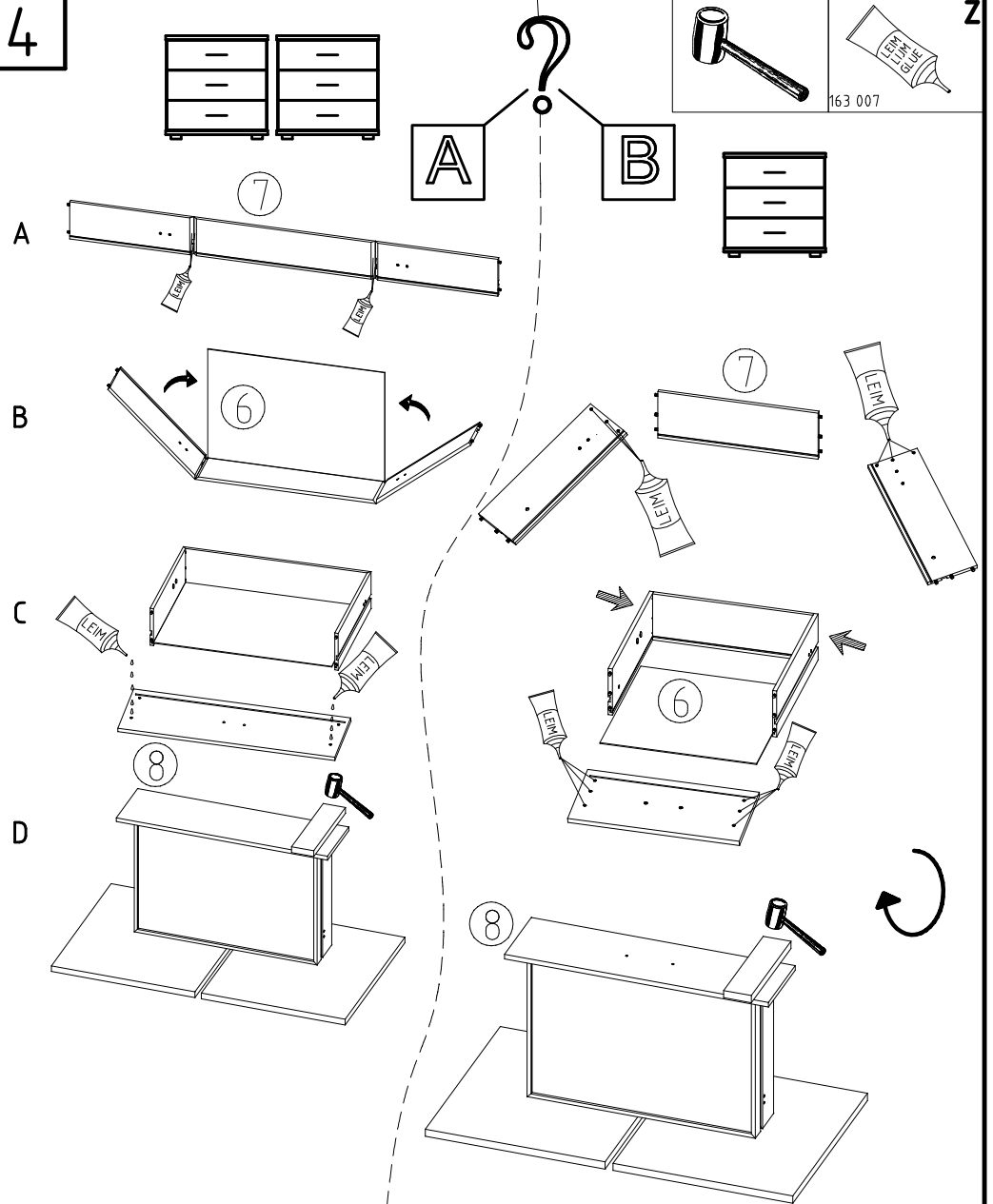

5

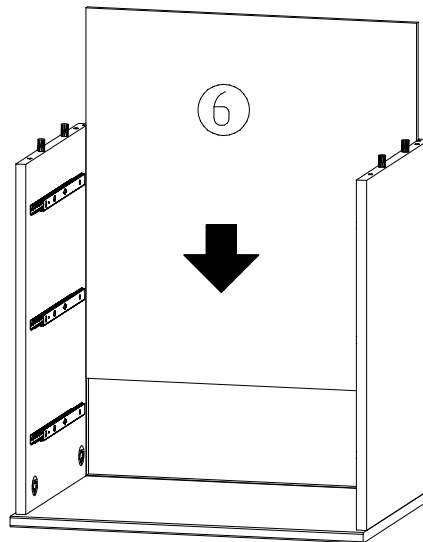
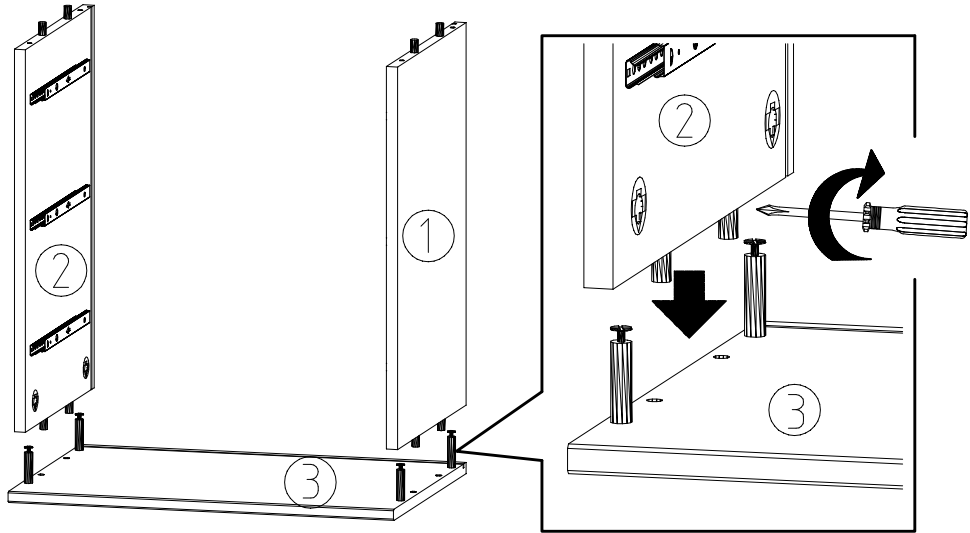
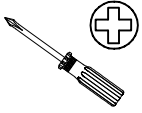

6

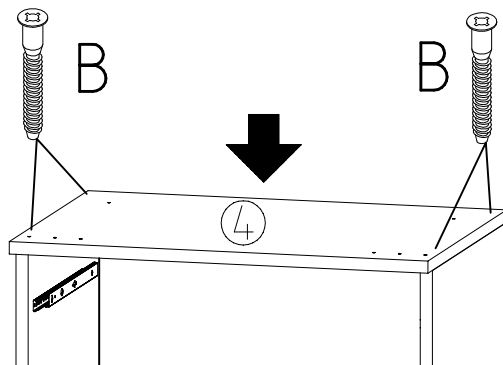
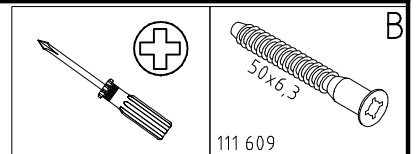

7

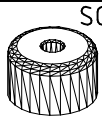
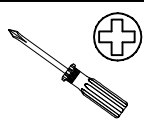

SG 25 4 X 23 mm SP23



121117

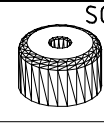
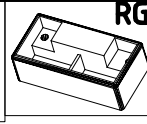
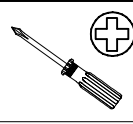

SG 25 4 X 23 mm SP23



121117

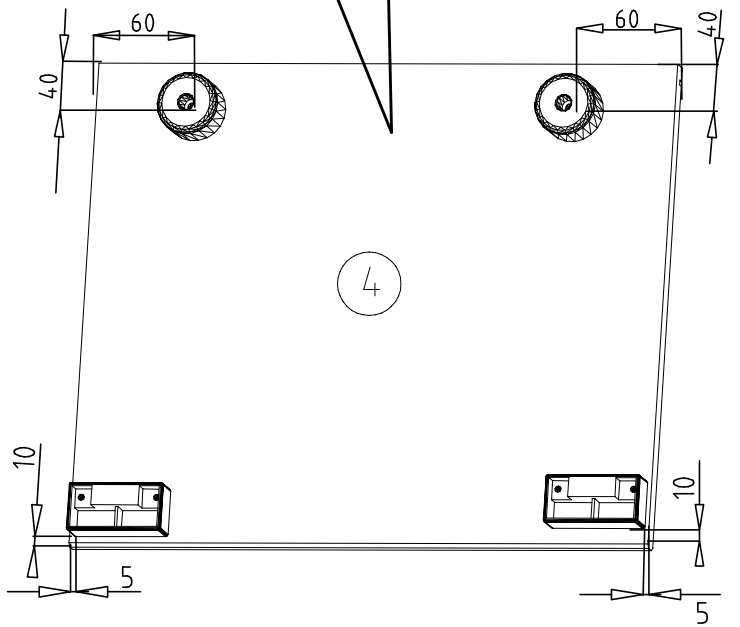
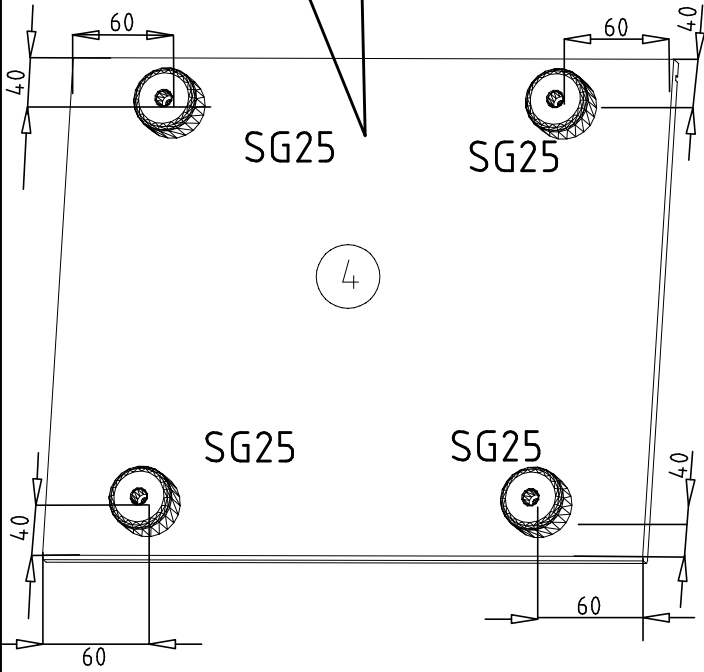
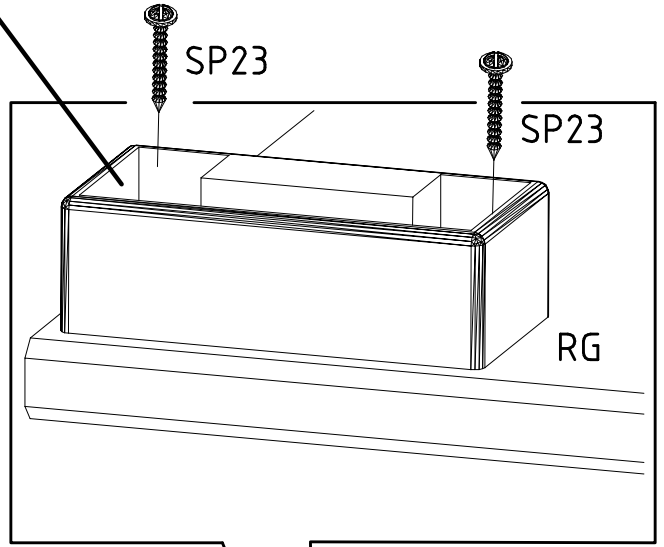
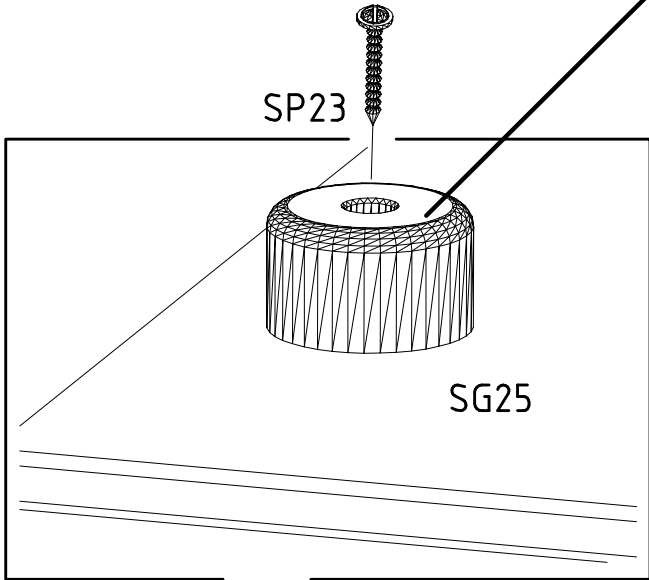
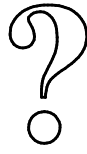

8

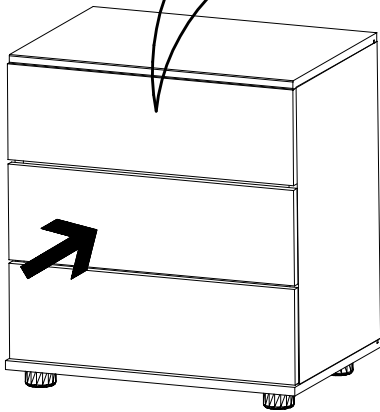
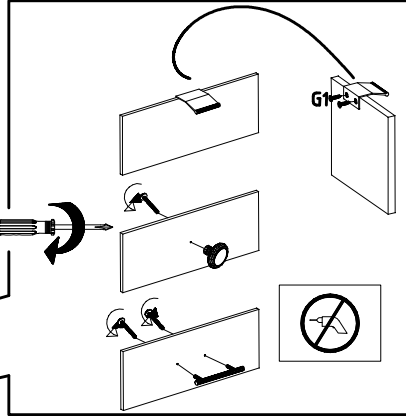
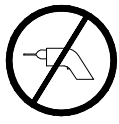

9

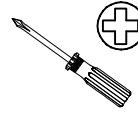

M4 x 9 mm

G8



111 015

G8

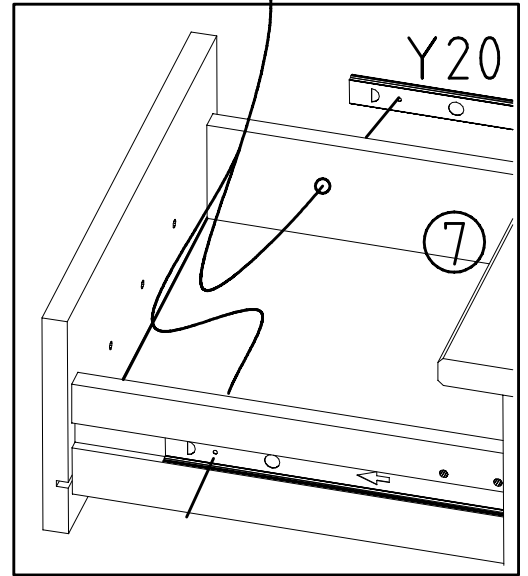

10

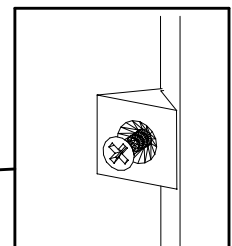
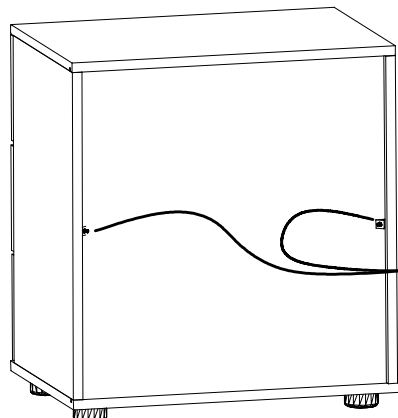
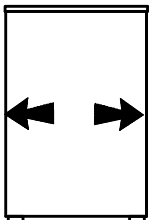
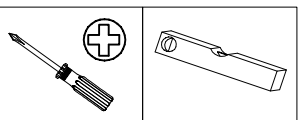
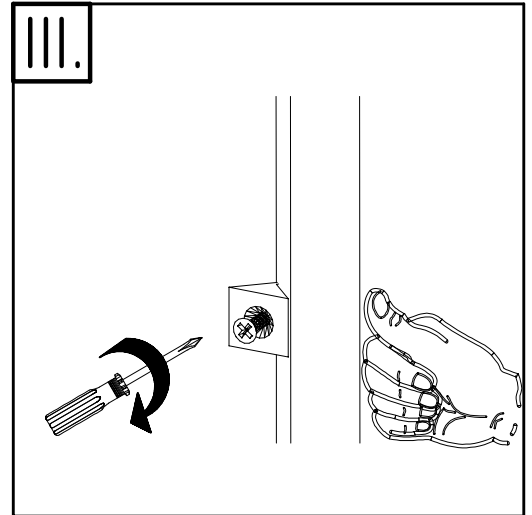
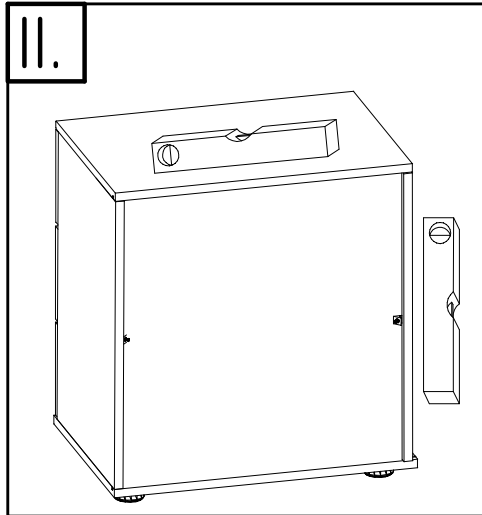
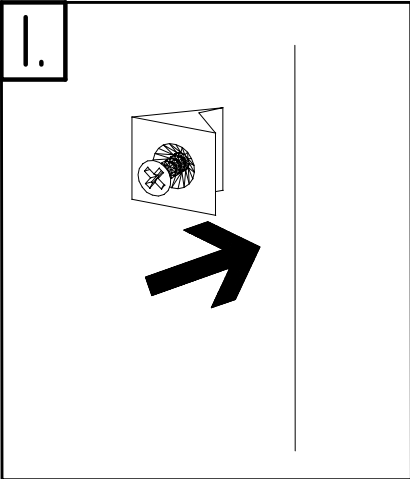
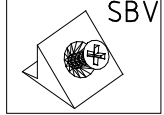

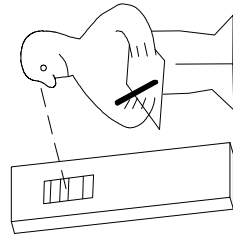
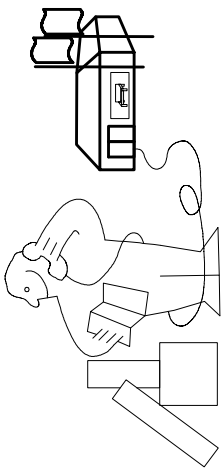
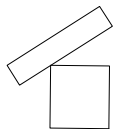
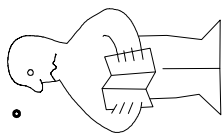

Modell/Model/Modèle

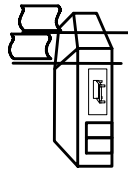

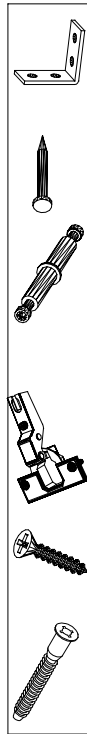

(121 370)	(G 1)	(4x)

Anderungen die dem technischen Fortschritt geschuldet sind, behalten wir uns vor!
 Bei nicht vorschriftsmäßiger und/ oder nicht fachmännischer Montage wird bei Personen- und/ oder Sachschäden keinerlei Haftung übernommen.

WIMEX Wohnbedarf Import Export Handels GmbH & CoKG / Postfach 14,07/ 49112 Georgsmarienhütte/ Germany
 Tel.:(+49) 054-01 8598 0 Fax:-(+49) 054-01 8598 33 Mail: service_H@wimex-online.com

104P-NR. / 104P-NO.	104P-NR. / 104P-NO.	AUTRES / L'ORDRE-NR. / NO. DE L'ORDRE
23203	30110XY	
Kunde / Customer / Client MAX MUSTERMANN		
Kommission / your order reference / votre reference 3377 MINDEN		
Dekor / Decor / Décor / Modell / Model / Modèle F99 SAMPLE		
F99842 SCHWEBETÜREN-SCHRANK 250 CM H 216CM PLANKENEICHE NB + RAU STEEL PLANKENEICHE NACHBILDUNG		
Paket / Package / Paquet 414760		
SOCKEL		
Paket / von 8		Colli / Kommission 10
HSP-SW1 BOD 50 TEXT / TEX SOCKEL 32 FRESH TV / LIT SO-BOD TEXT RASTEX / ZWBOD D18MM 1X KLSTA 104		
Montage - Anleitung KS-64 Laenge 520,0 Breite 568,0		
SOCKEL32 KLEB		



104
 OBEN
 5
 30/19
 HAUT
 SOUVENIR / 1. ABOVE
 23.08.19
 OBEN

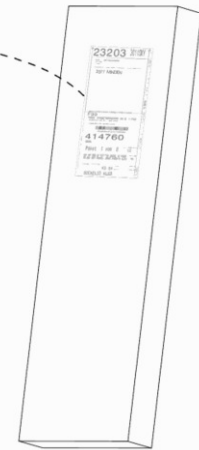

WIMEX Wohnbedarf	
Import Export Handelsges mbH & Co. KG	
Werner-von-Siemens-Str. 35	
D-49124 Georgsmarienhütte - Germany	
SAMPLE	23.08.19
Modellname Model	Produktionsdatum Date of manufacture

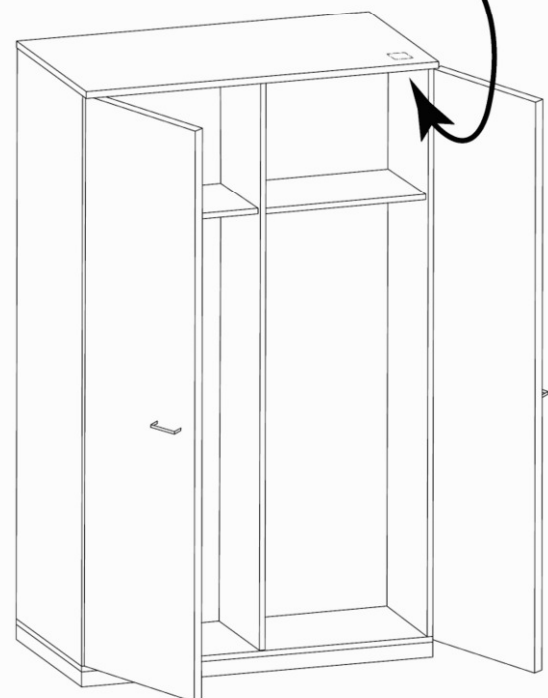
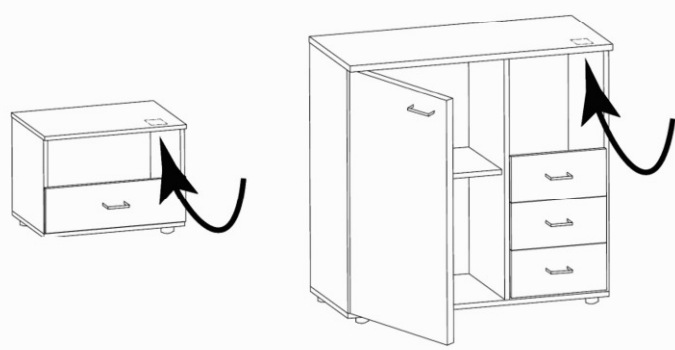
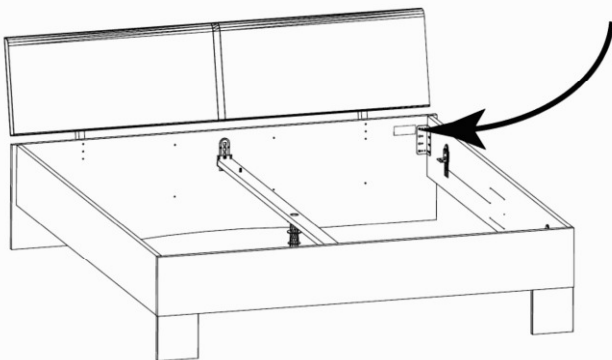

980225

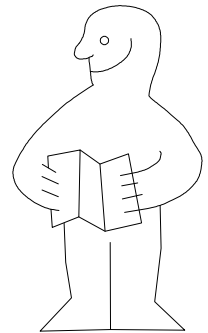
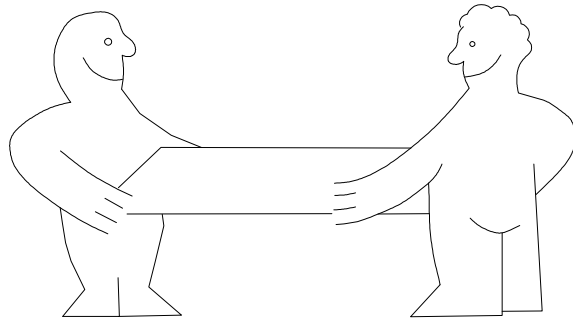
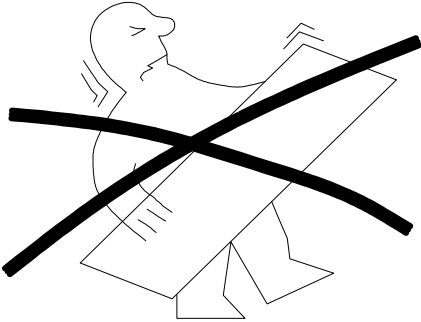
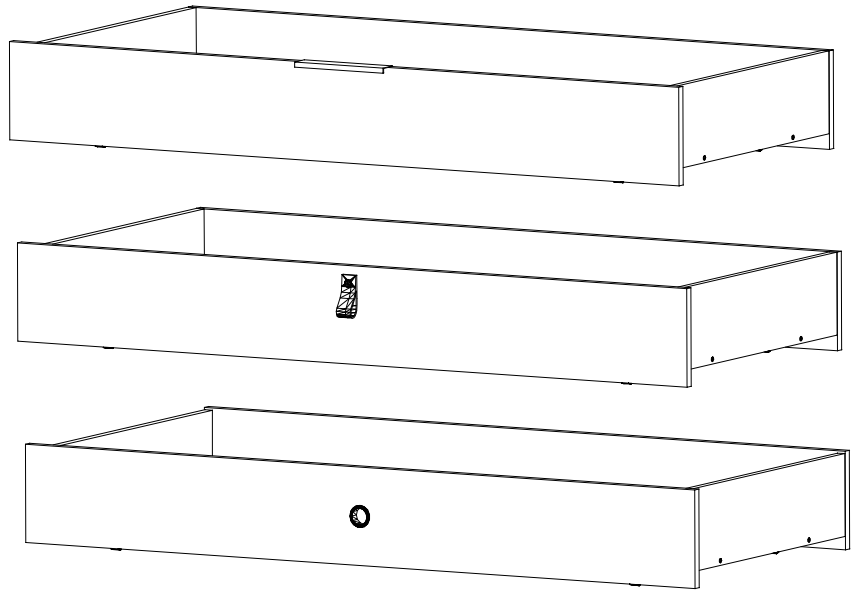
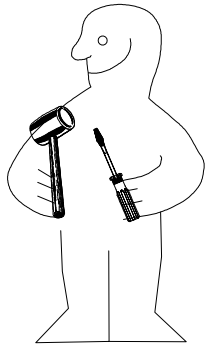

1-2-3-4... ○ ○

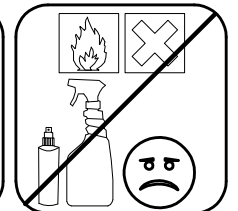
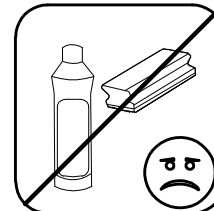
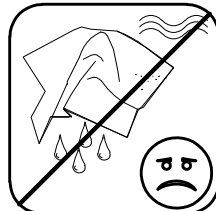
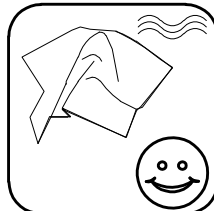
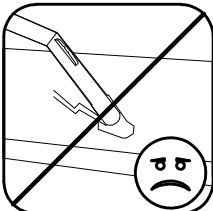
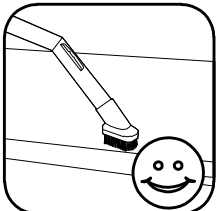
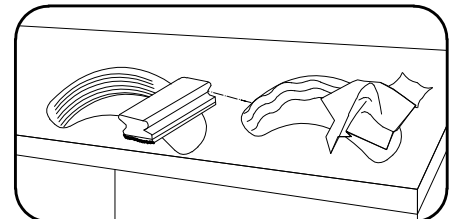
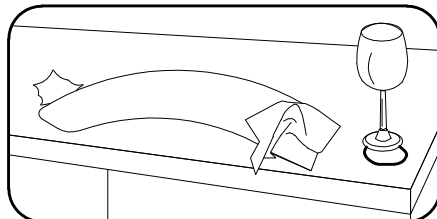
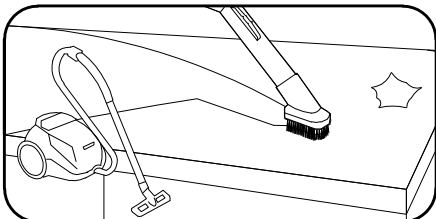
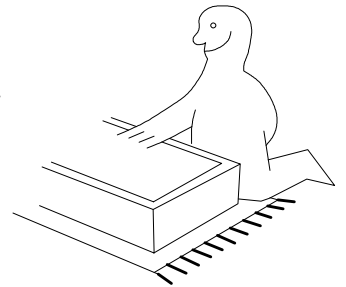
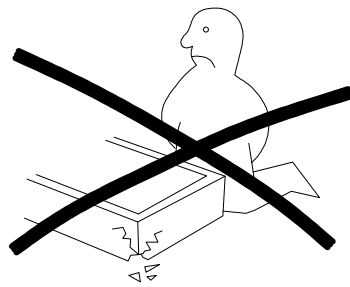
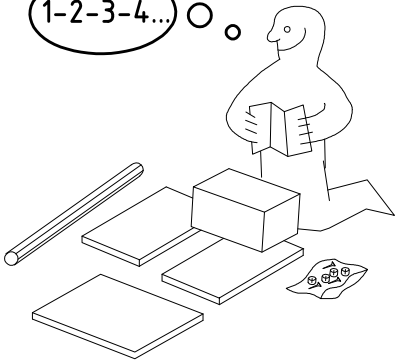

980225

24.05.12 / 23.10.18

10 18

1/4

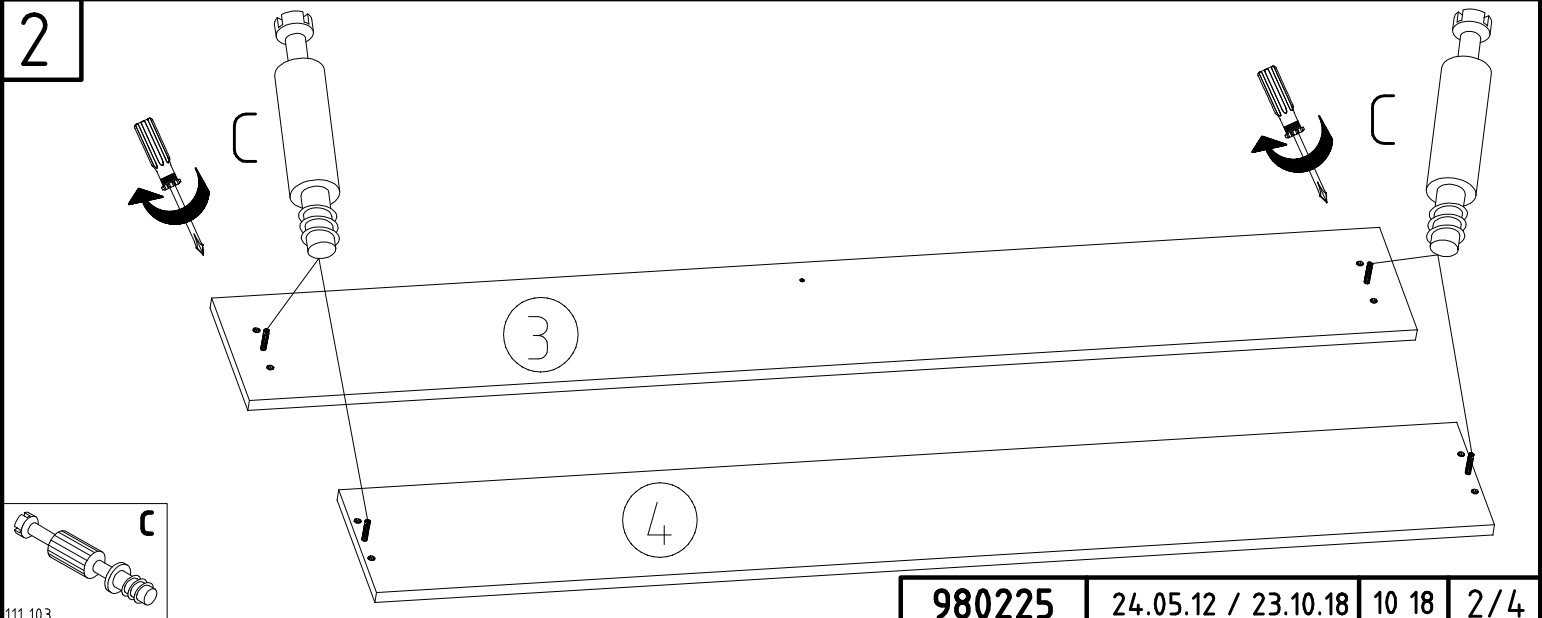
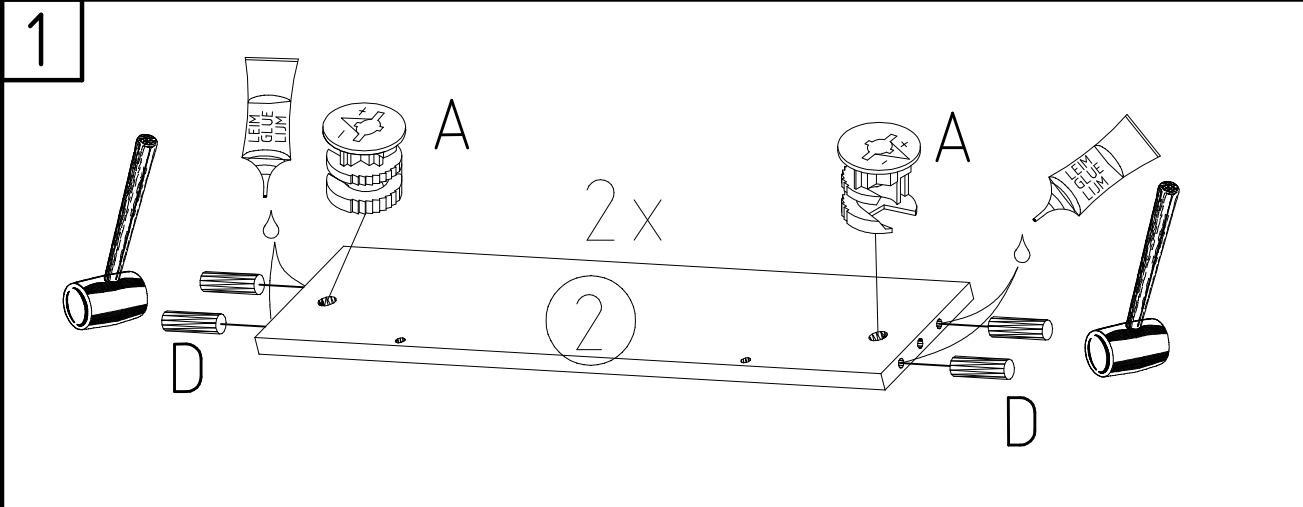
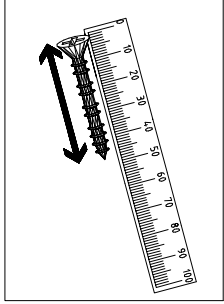
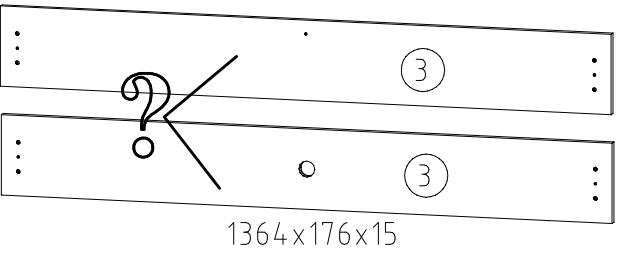
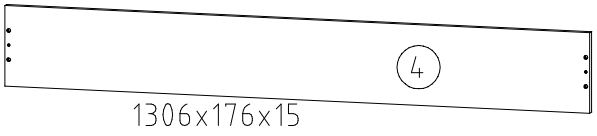
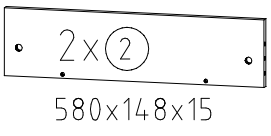
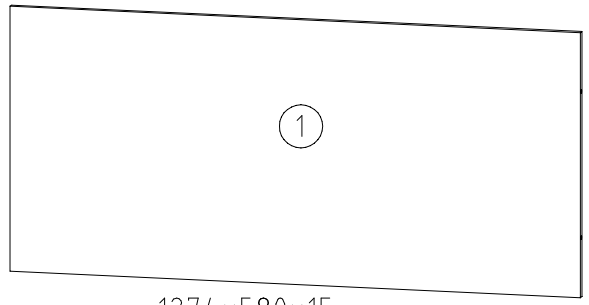
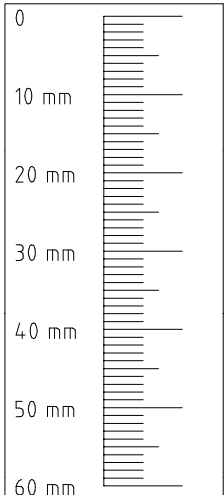
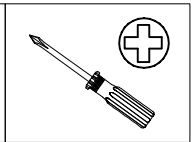
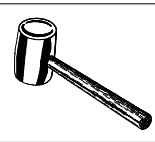
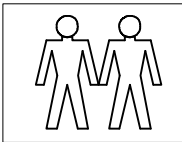
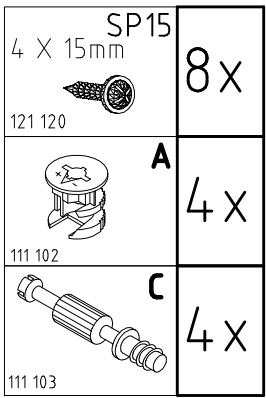
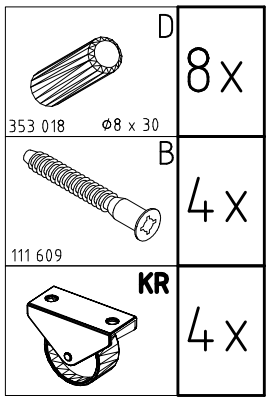
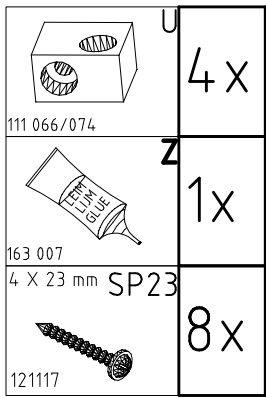

4

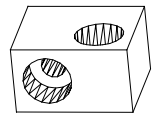
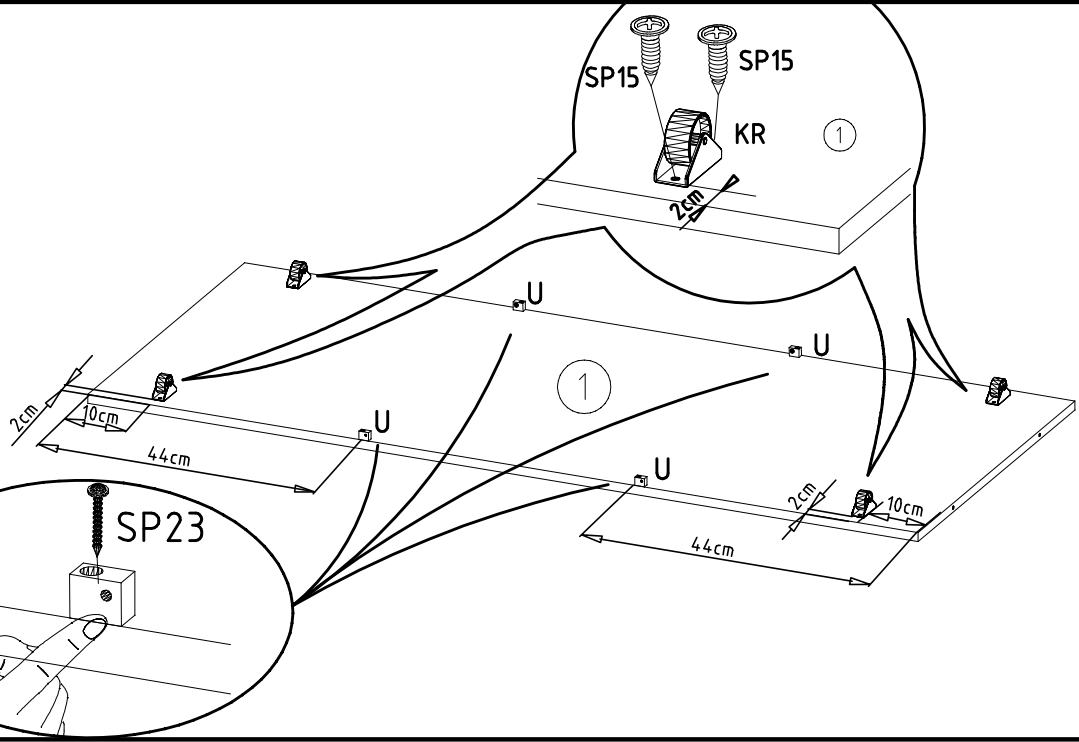

111 066/074
4 X 23 mm SP23

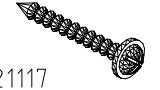

121117

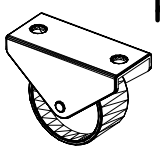

KR

SP15
4 X 15mm

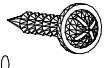

121 120

5

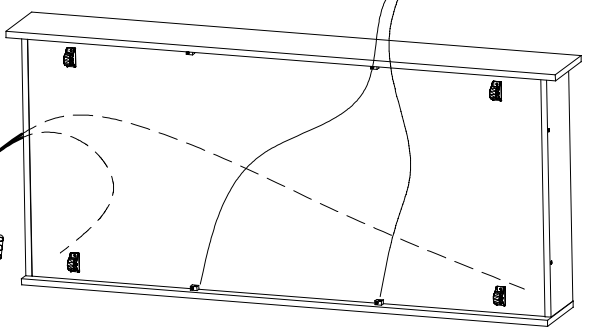
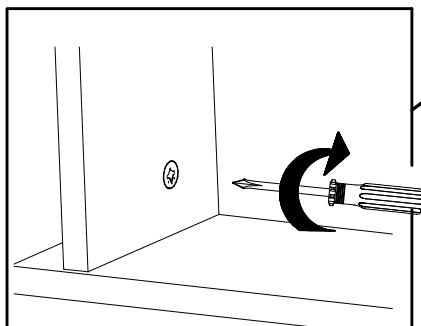
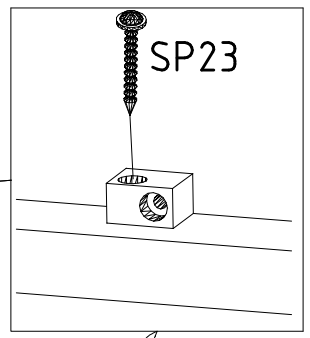
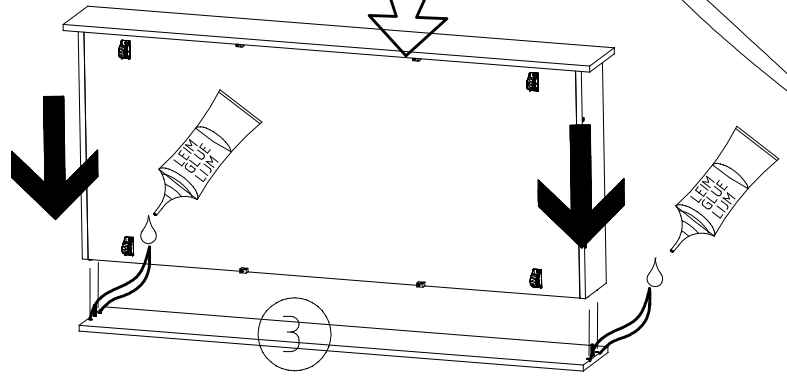
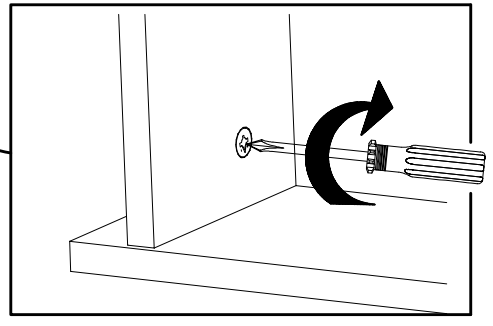
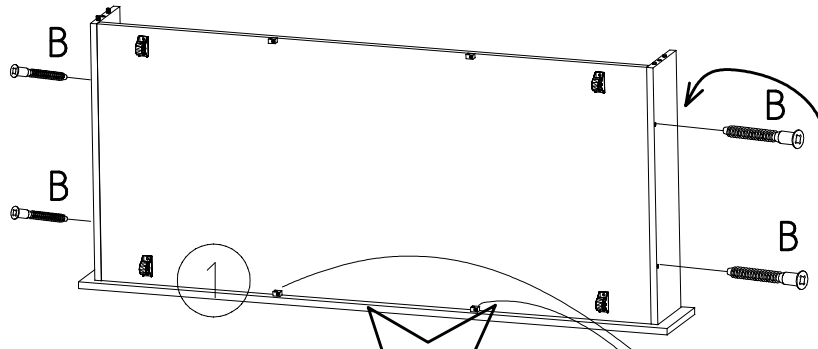
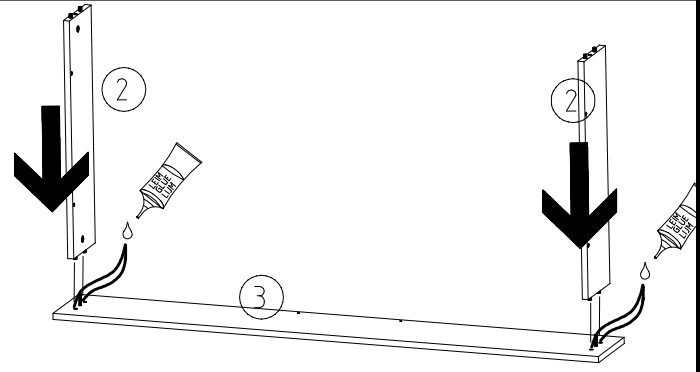
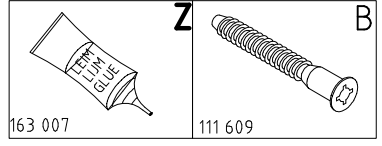

6

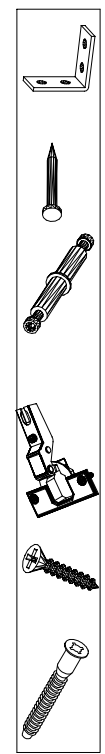
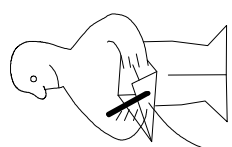
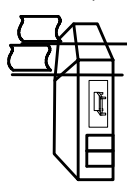
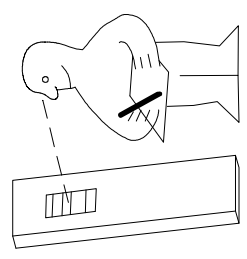
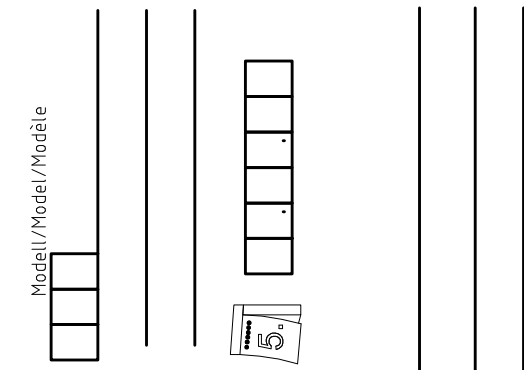
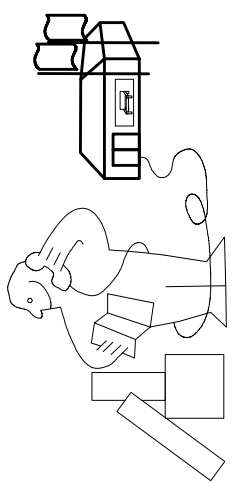
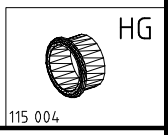
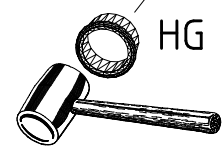
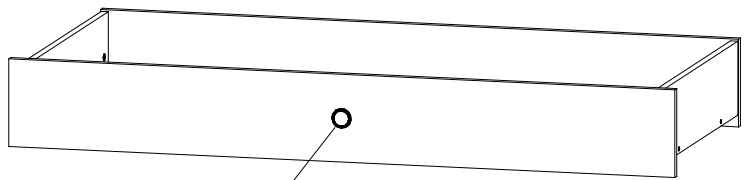
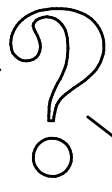
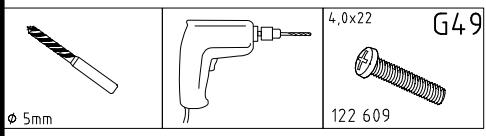
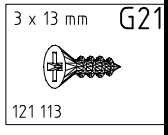
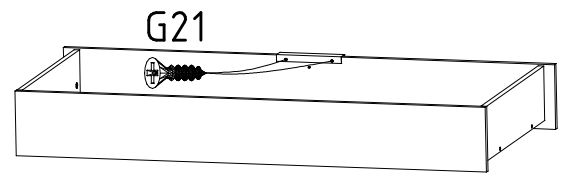
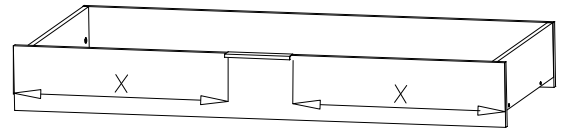
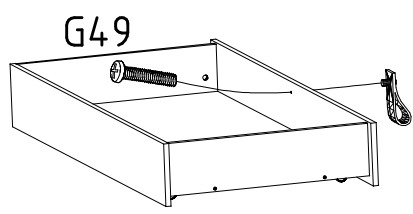
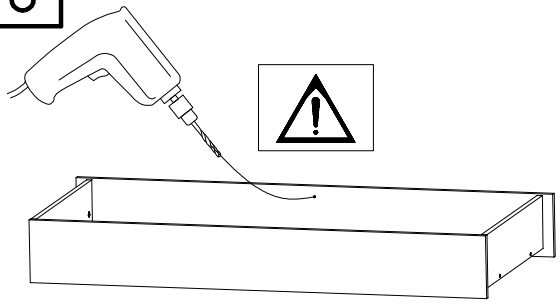

<121 370>	< G 1 >	<4x>

Änderungen die dem technischen Fortschritt geschuldet sind behalten wir uns vor!
 Bei nicht vorschriftsmäßiger und/ oder nicht fachmännischer Montage wird bei Personen- und/ oder Sachschäden keinerlei Haftung übernommen.
 WIMEX Wohnbedarf/ Import Export Handels GmbH/ Postfach 14.07/ 49112 Georgsmarienhütte/ Germany
 Tel.:(+49) 054.01 8598 72 Fax:(+49) 054.01 8598 33 Mail: service_H@wimex-online.com

980410

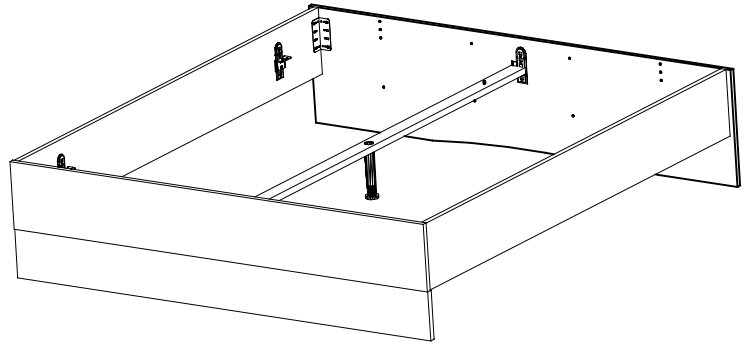
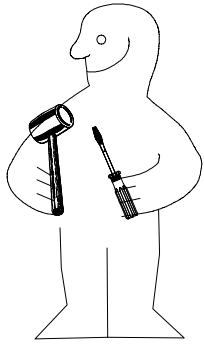

BS 260

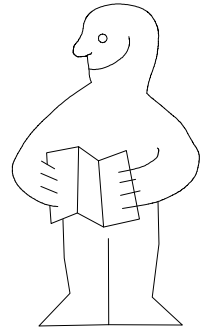
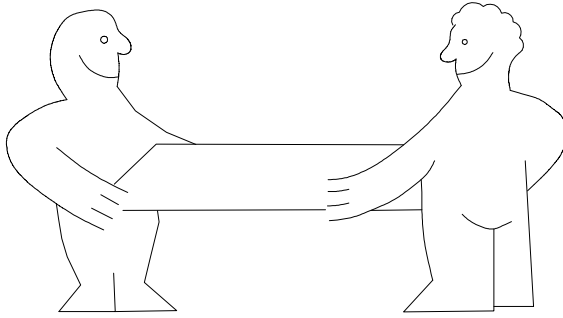
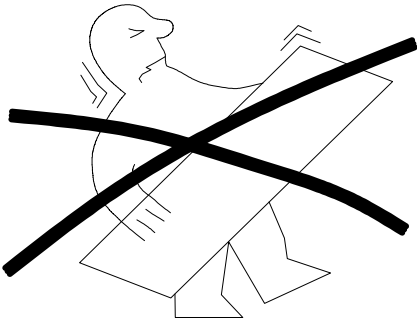

1-2-3-4... ○ ○

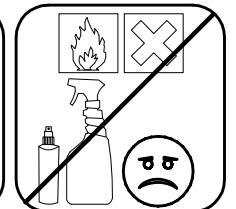
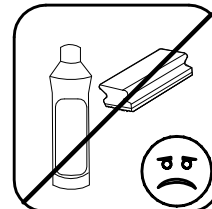
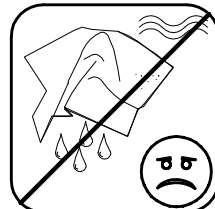
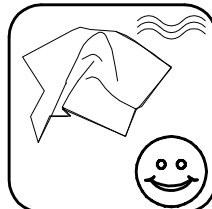
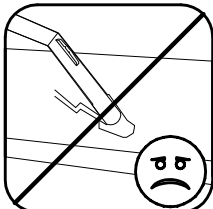
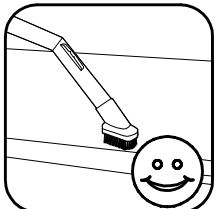
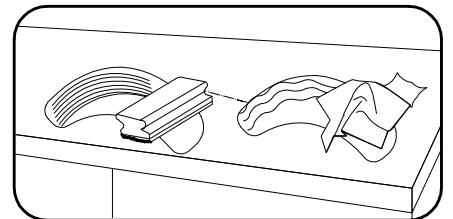
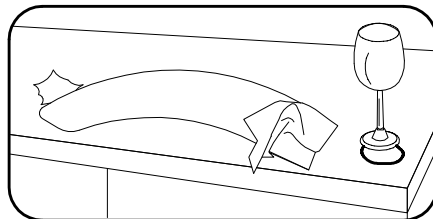
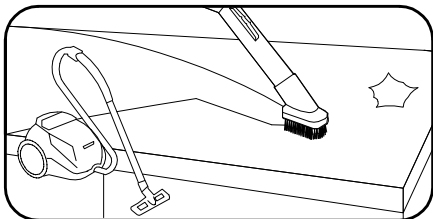
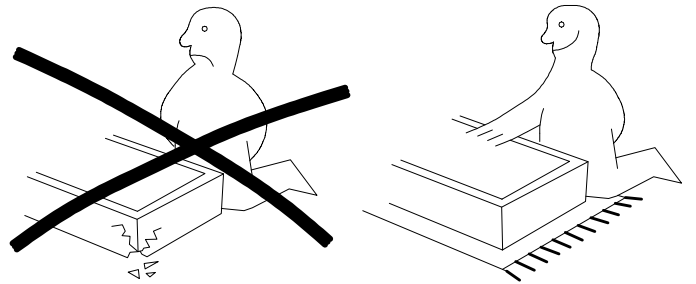
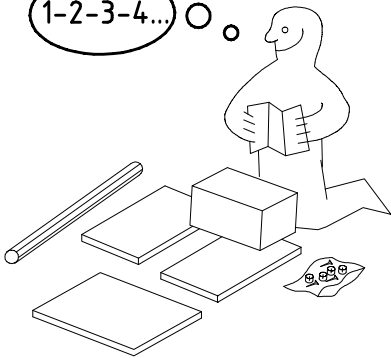





980410

17.06.14 / 30.11.22

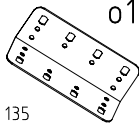
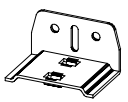
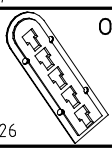
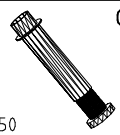
11 22

1/6

 111 135	014 4x
 111 627	07 6x
 111 626	06 6x
 111650	09 1x

 121 130	4 X 20 mm G22 16x
 121 110	4,0 x 15 mm G23 20x
 121 148	6,0 x 12 mm G4 6x

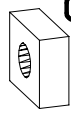
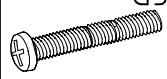
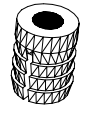
 129 407	US 4x
 121 150	φ12 G6 4x
 121 149	5,0 x 35 mm G51 4x
 111 112	φ 10 x 13 mm H 6x

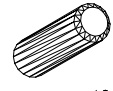
 121 121	4 X 20mm SP20 25x
 353 018	D φ8 x 30 2x

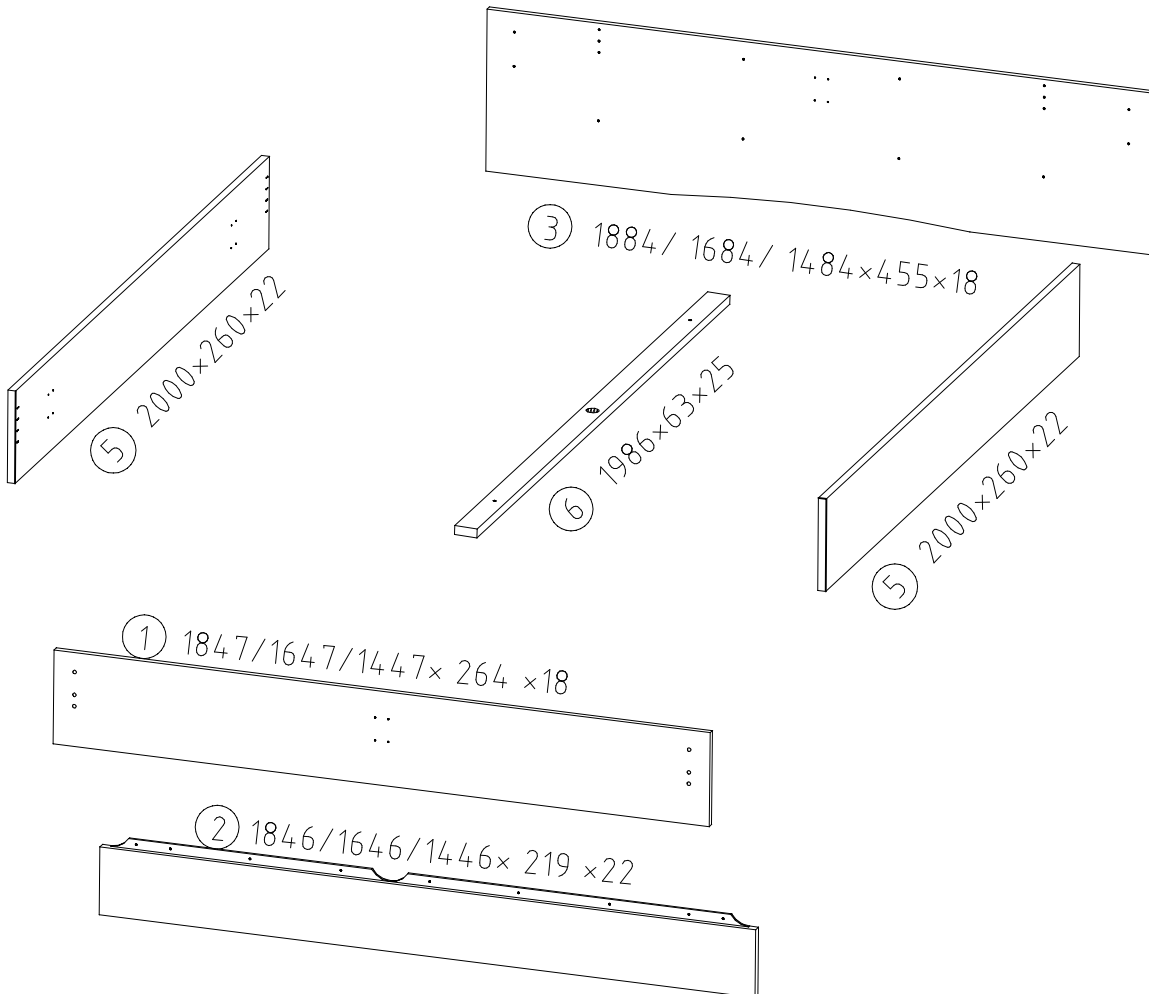
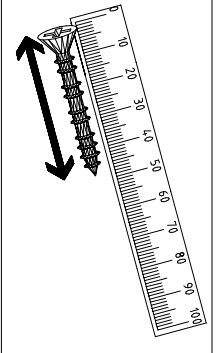
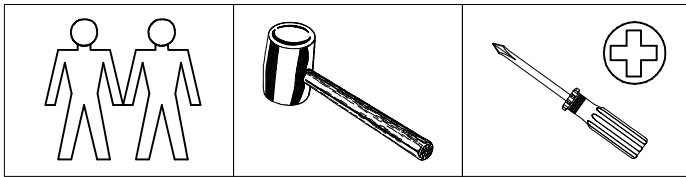
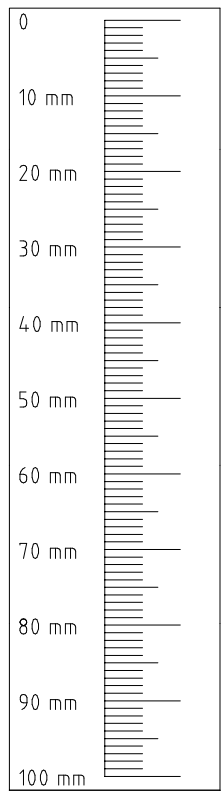

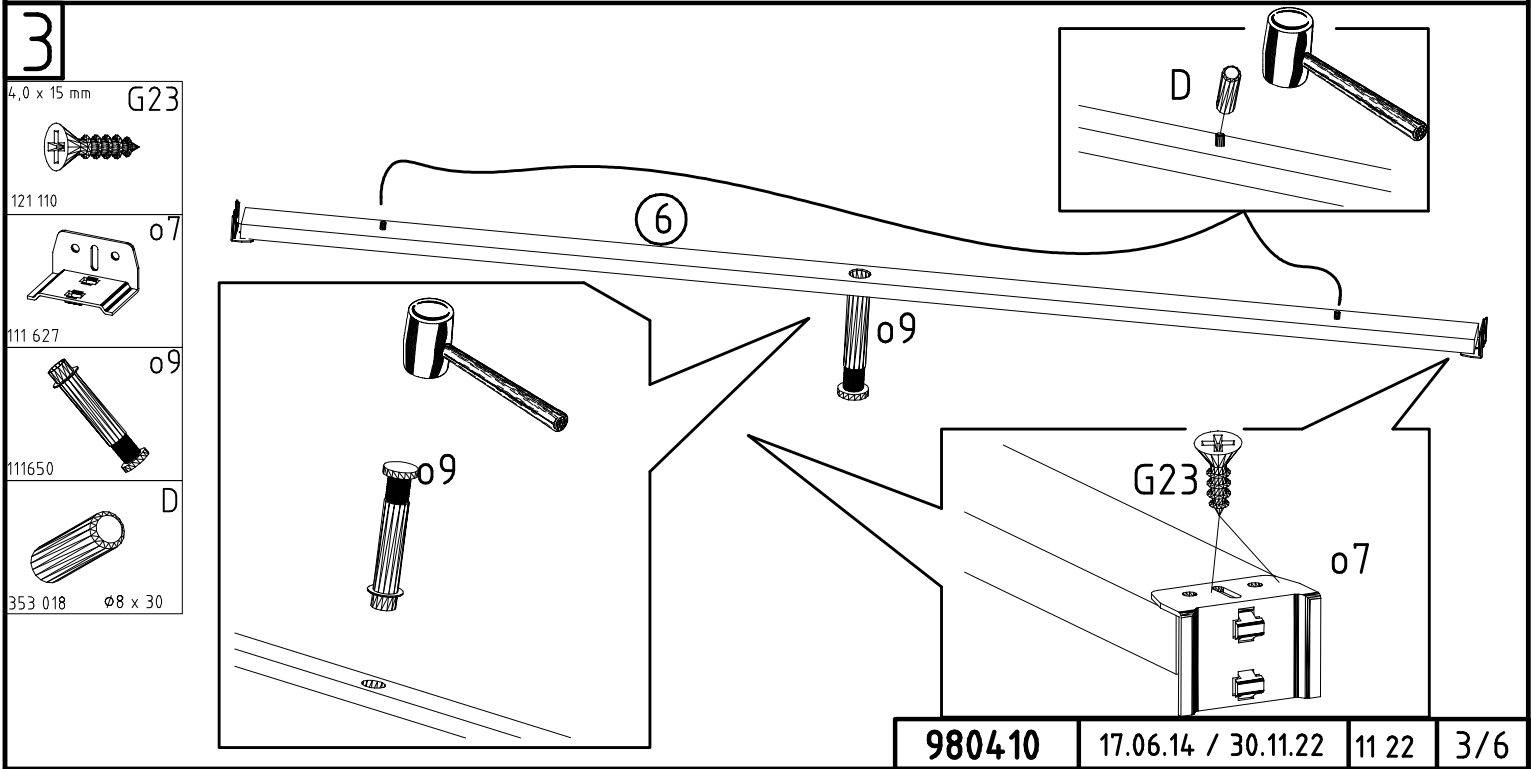
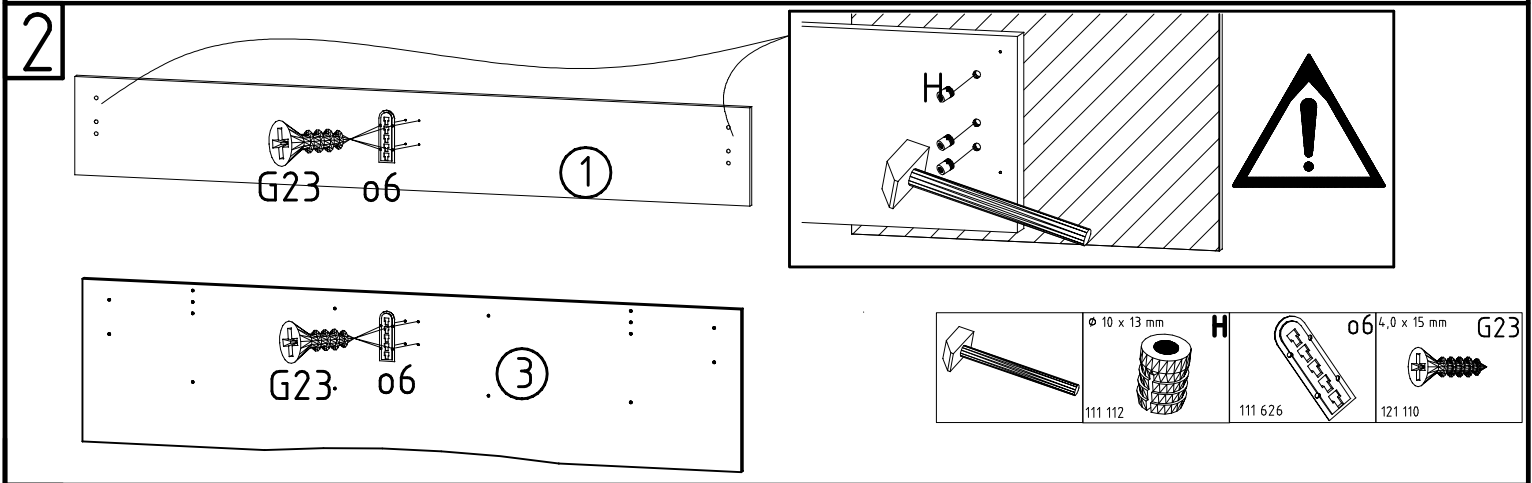
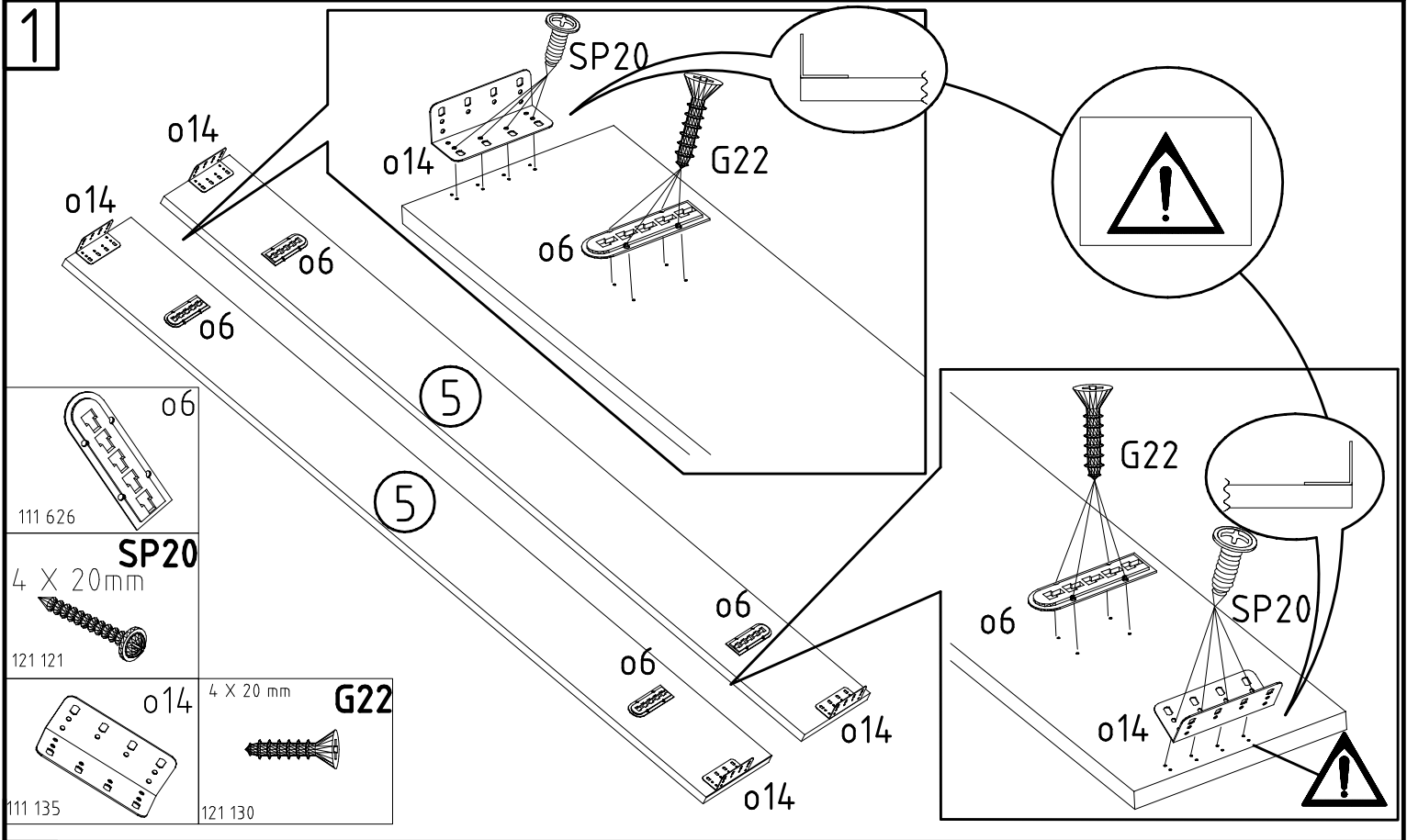

4

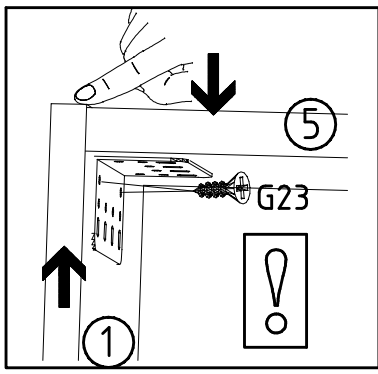
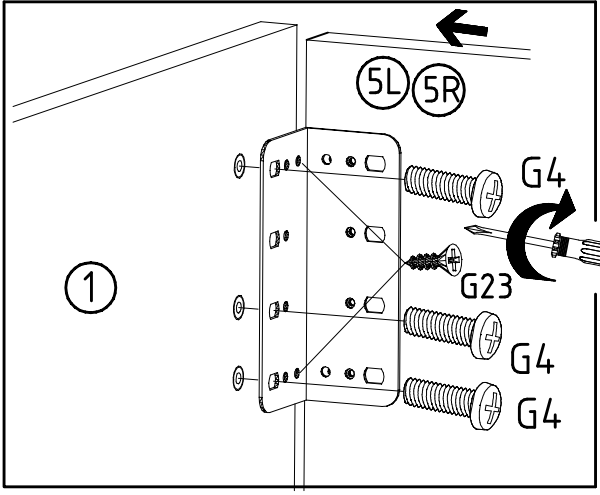

4,0 x 15 mm G23 121 110	6,0 x 12 mm G4 121 148

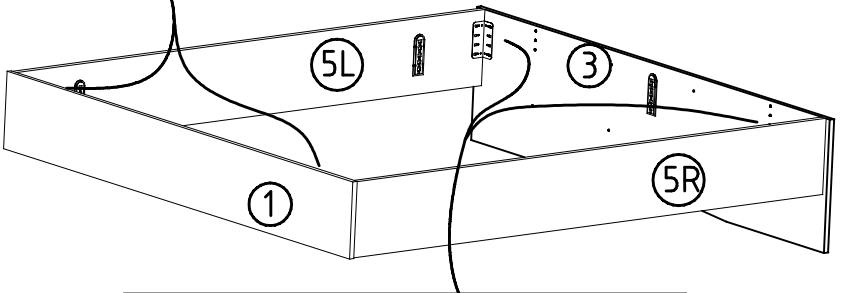

5

5,0 x 35 mm G51 121 149	G6 121 150
US φ12 129 407	4,0 x 15 mm G23 121 110

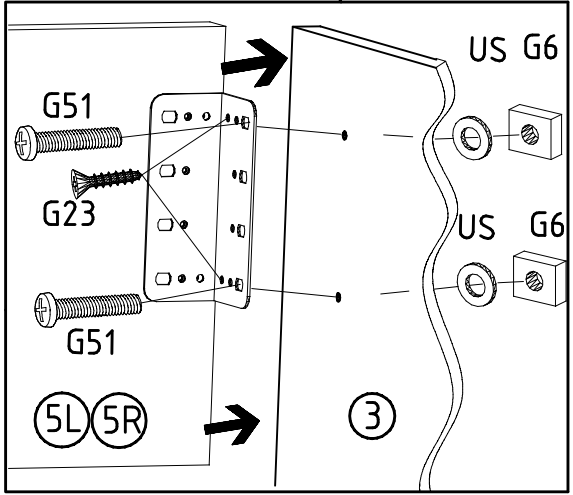

6

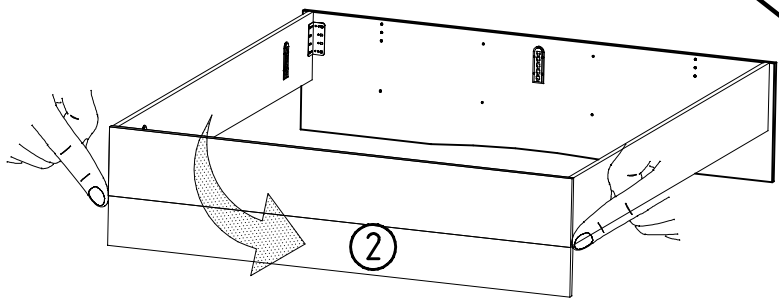

SP20
4 X 20mm
121 121

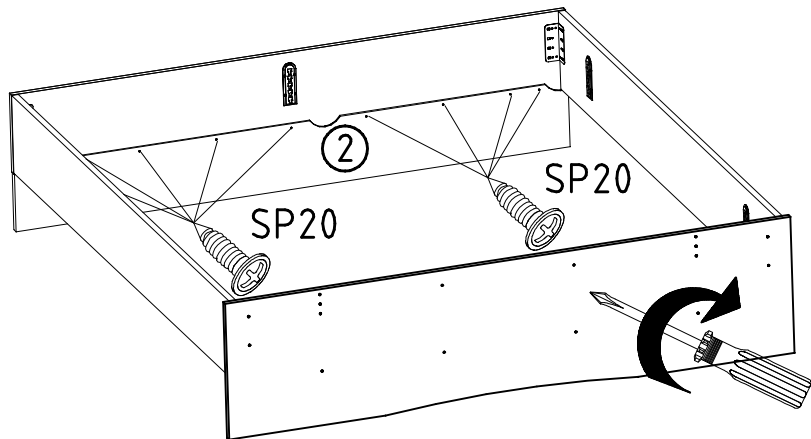
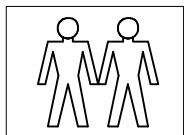

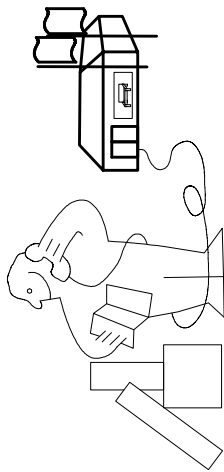
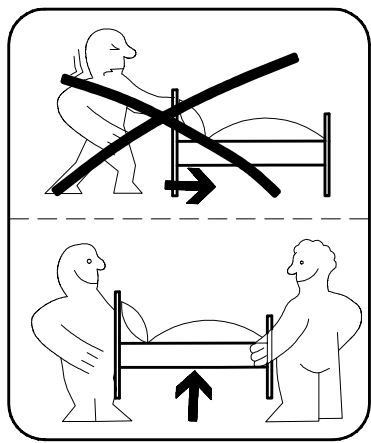
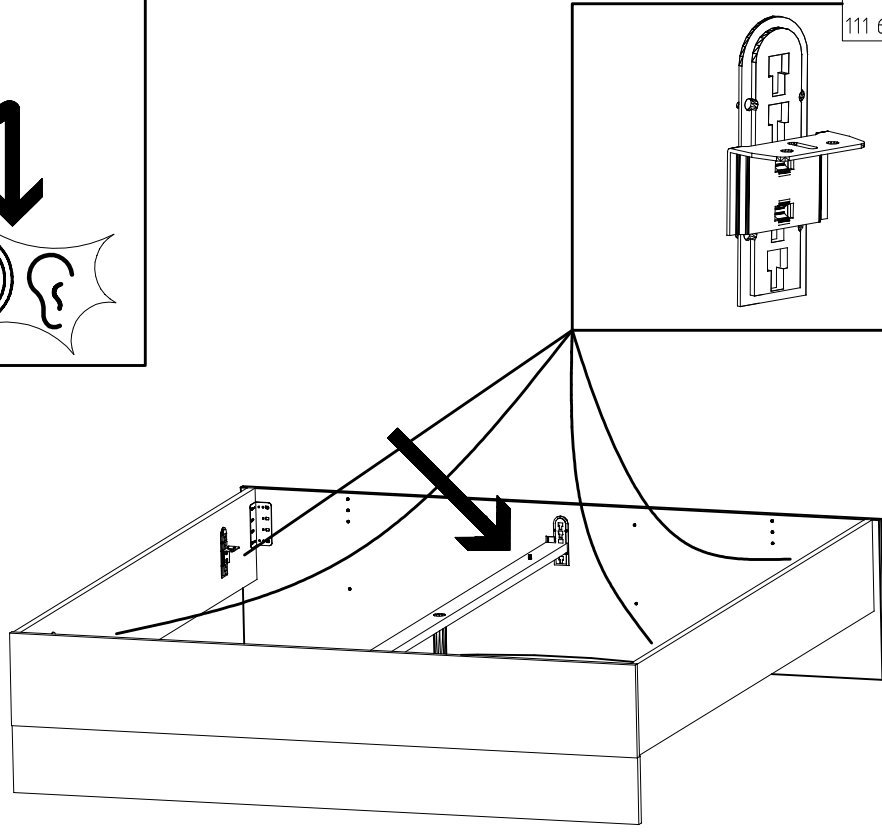
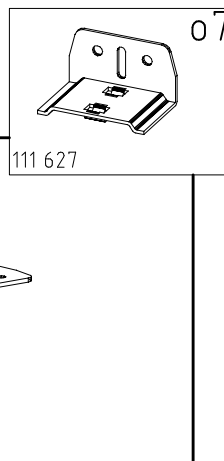
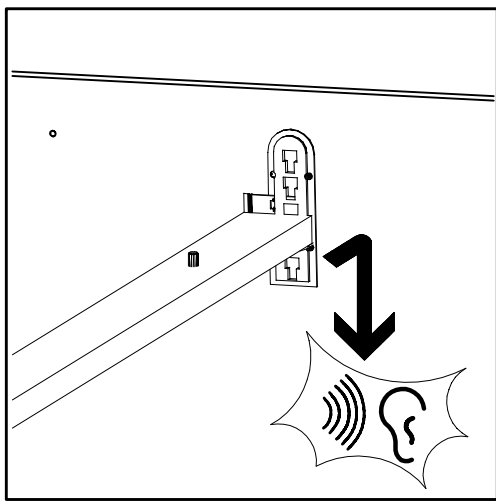

Modell/Modèle

5

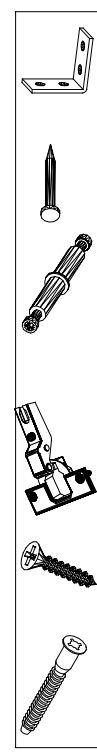

<121 370>	< G 1 >	<4x>

Änderungen die dem technischen Fortschritt geschuldet sind, behalten wir uns vor!
 Bei nicht vorschriftsmäßiger und/ oder nicht fachmännischer Montage wird bei Personen- und/ oder Sachschäden keinerlei Haftung übernommen.
 WIMEX Wohnbedarf Import Export Handels GmbH & CoKG / Postfach 1407 / 49112 Georgsmarienhütte / Germany
 Tel.:(+49) 05401 8598 0 Fax.:(+49) 05401 8598 33 Mail: service_H@wimex-online.com

23203	30110XY
Kunde / Customer / Client: MAX MUSTERMANN	
Kommission / your order reference / votre reference: 3377 MINDEN	
Dekor / Decor: F99	
Modell / Model: SAMPLE	
F99842 SCHWELTUEBENSCHRANK 250 CM H 216CM PLANKENEICHE NB + RAU STEEL PLANKENEICHE NACHBILDUNG	
414760	
SOCKEL	
Paket / Package / Paquet: 1 von 8	Colli / Commission: 10
HSP-SWT BOD 50 TEXT/TEX SOCKEL 32 FRESH SO-BOD TEXT RASTEX/ ZWBOD D18MM 1X KLSTA	
Montage - Anleitung: KS-64	Laenge: 520,0 Breite: 568,0
SOCKEL32 KLEB	



104
 OBEREN 5 30/19
 HAUT
 23.08.19
 OBEREN 11
 ABOVE
 OBEREN



WIMEX Wohnbedarf
 Import Export Handelsges mbH & Co. KG
 Werner-von-Siemens-Str. 35
 D-49124 Georgsmarienhütte - Germany

SAMPLE
 Modellname
 Model

23.08.19
 Produktionsdatum
 Date of manufacture

