

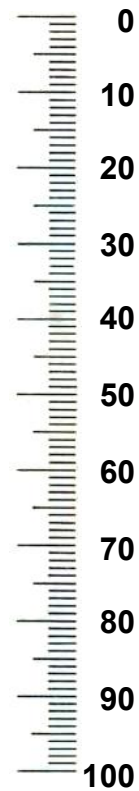

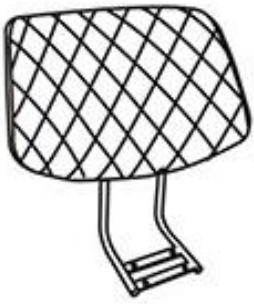





Typ: Nr. 086-8639

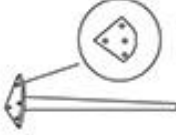
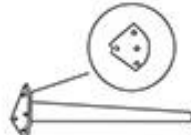

 Ax1	 Bx1	Front leg  Cx2	Back Leg  Dx2	 Ex1
	 Fx2	 M6x16 Gx12	 M6x20 Hx2	 M6x25 Ix2

①

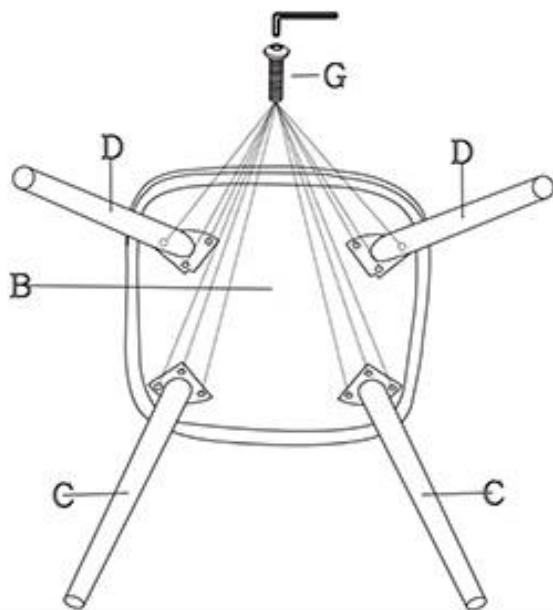

②

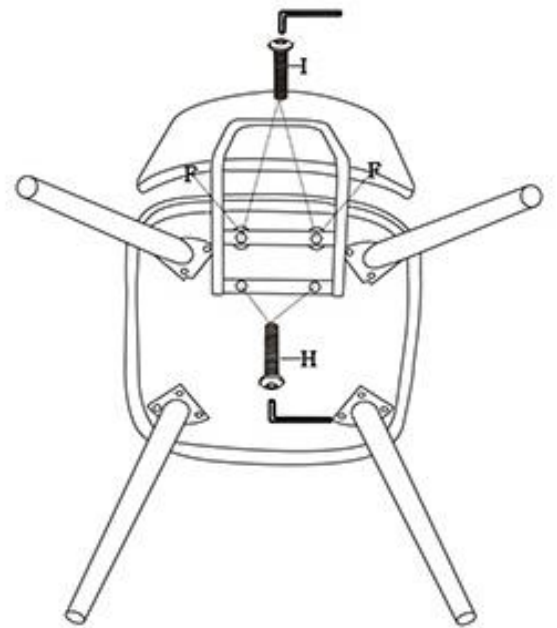

③

