

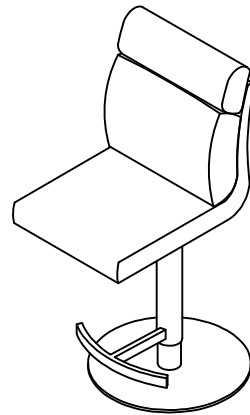

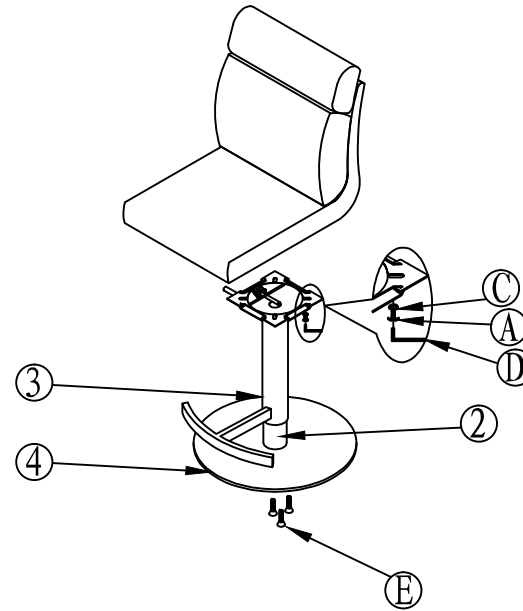

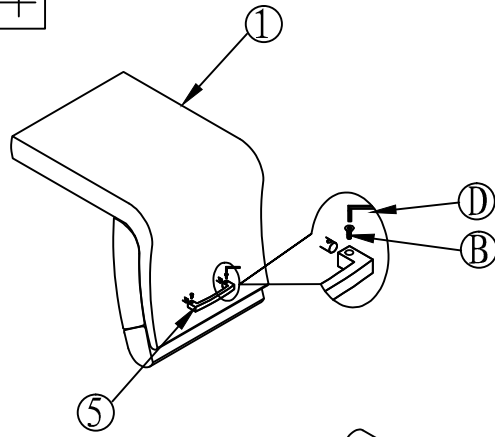

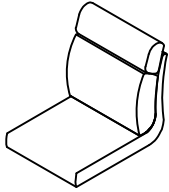
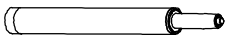

RABEA

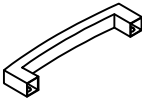
MCA
furniture



1		1X
2		1X
3		1X
4		1X
5		1X
A	 M6*12mm	4X
B	 M5*10mm	2X
C	 M6	4X
D	 #4	1X
E	 M8*30mm	3X

D	Bitte überprüfen Sie in regelmäßigen Abständen den festen Sitz der Schrauben!	NL	Controleer op regelmatige afstanden of de schroeven goed vast zitten.
GB	Please check the screws for tightness at regular intervals!	SWE	Kontrollera med jämna mellanrum att skruvarna sitter fast ordentligt!
F	Veuillez contrôler régulièrement que les vis sont convenablement serrées !	SK	V pravidelných intervalech kontrolujte pevné dotiahnutie skrutiek!
ES	¡Compruebe periódicamente que los tornillos estén bien apretados!	SL	Redno preverjajte, ali so vijaki trdno priviti!
IT	Controllare regolarmente che le viti siano ben strette!	HR	Redovito provjeravajte čvrsto nalijeganje vijaka!
PL	Należy regularnie sprawdzać dokręcenie śrub!		

D	Es wird dazu geraten die Schraubverbindungen der Bodenplatte vor der Montage des Sitzpolsters auf festen Sitz zu überprüfen!	NL	Het is aan te raden om vóór de montage van het zitkussen te controleren of de schroefverbindingen van de montageplaat goed aangedraaid zijn!
GB	We recommend that you check the screw connections of the base plate for tight fit before attaching the seat cushion!	SWE	Vi rekommenderar att kontrollera att bottenplattans skruvförband sitter ordentligt fast innan sittdynan monteras!
F	Pour ce faire, il est recommandé de vérifier si les raccords boulonnés de la plaque de base sont solidement fixés avant le montage de la garniture du siège.	SK	Odporúčame, aby ste pred montážou sedáka skontrolovali pevnosť skrutkových spojov na spodnej doske!
ES	Se aconseja comprobar que las conexiones de los tornillos de la base se encuentren en el lugar correcto antes de montar el cojín del asiento.	SL	Zato svetujemo, da pred montažo sedežne blazine preverite, ali so vijačni spoji trdni!
IT	Prima del montaggio del cuscino del sedile, si consiglia di controllare la tenuta delle viti della piastra di base.	HR	Preporučuje se da prije postavljanja jastuka za sjedenje provjerite pričvršćenost vijčanih spojeva podne ploče!
PL	Przed zamontowaniem poduszki siedzenia zaleca się sprawdzenie odpowiedniego dokręcenia połączeń śrubowych!		