

- | | |
|---------------------------------------|-----------------------------------|
| D Montageanleitung | GB Assembly instructions |
| FR Notice de montage | IT Istruzioni di montaggio |
| NL Handleiding voor de montage | PL Instrukcja montażu |
| CZ Montážní návod | SK Návod na montáž |
| HU Szerelési útmutató | RO Instrucțiuni de montaj |
| TR Montaj talimati | RU ИНСТРУКЦИЯ ПО МОНТАЖУ |

4290-300/99

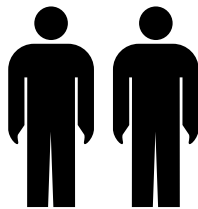
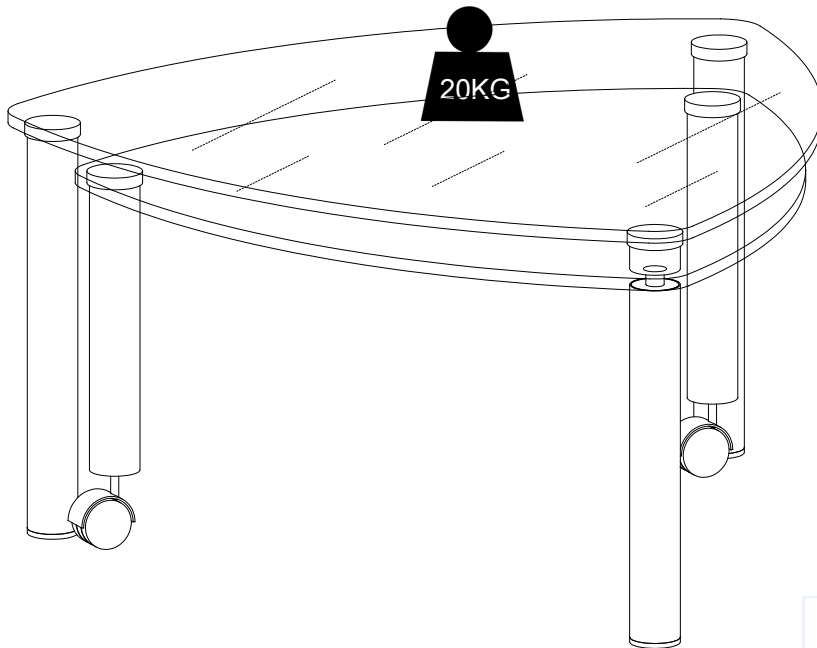

Service • Asststenza • Dienstverlening • Serwis Servis • Szerviz • Сервисная служба

Name • Nom • Nome • Naam •
Nazwa • Jméno • Názow • Név •
Denumire • Isim • Название

Nr. • No. • N° • Номер • Č • Sz

Typ • Type • Tip • Típus • Tipo •
Тип

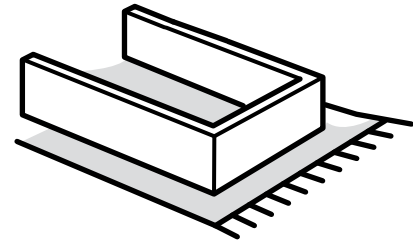
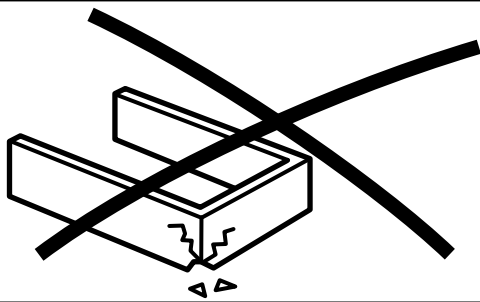
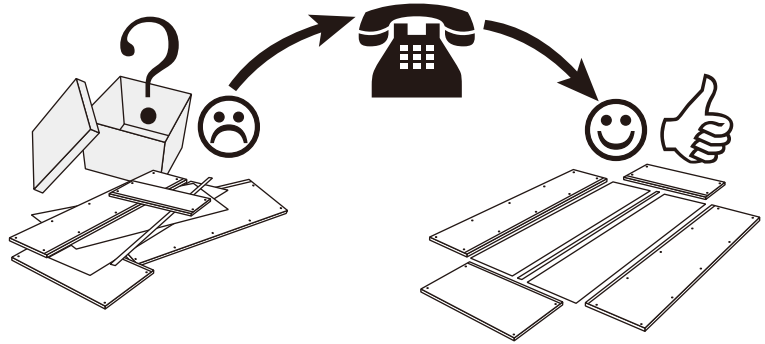
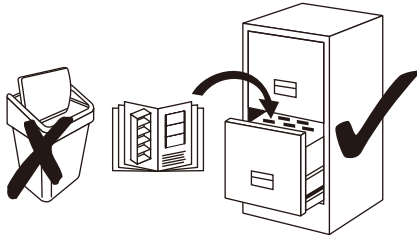

①	②	③	④	⑤	⑥
Ø5/16**35MM	Ø5/16**18MM	Ø50*1.5MM	Ø21*14MM	12MM	Ø5/16**50MM
5x	1x	2x	1x	1x	2x

A 805*805*12mm 1x	B 730*730*12mm 1x	C Ø50.8*403mm 2x
D Ø50.8*377mm 1x	E Ø50.8*294mm 2x	F Ø50.8*26mm 1x

Schritt 1

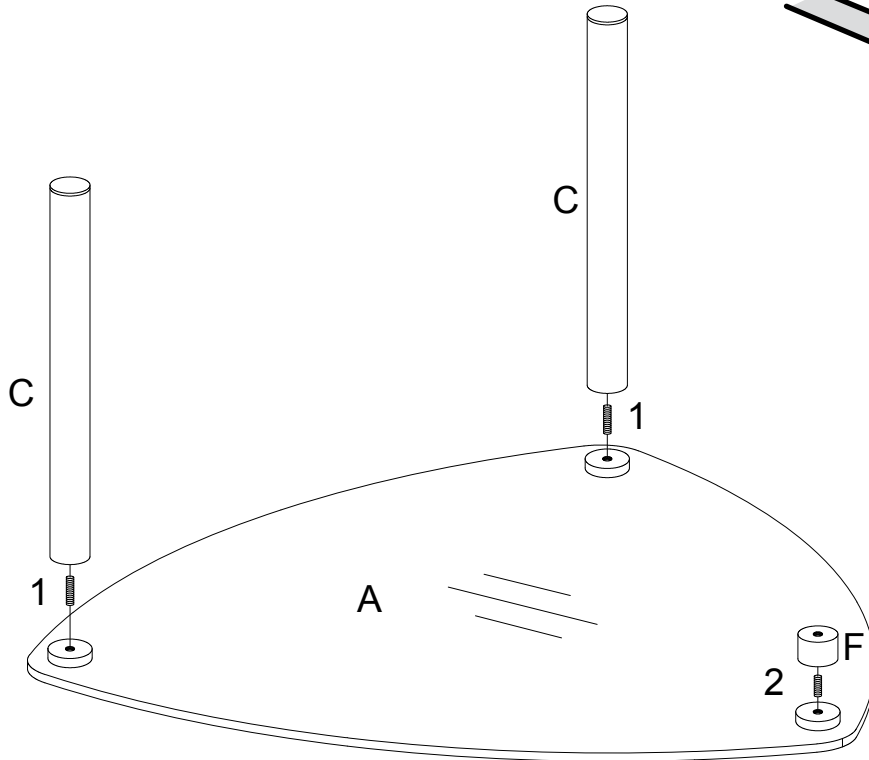
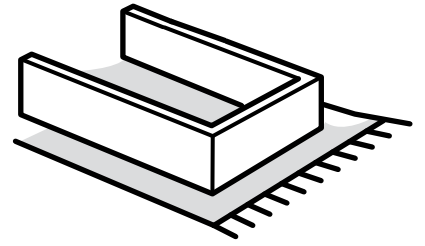

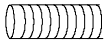
2	1x
	
Ø 5/16" * 18MM	

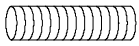
1	5x
	
Ø 5/16" * 35MM	

Schritt 2

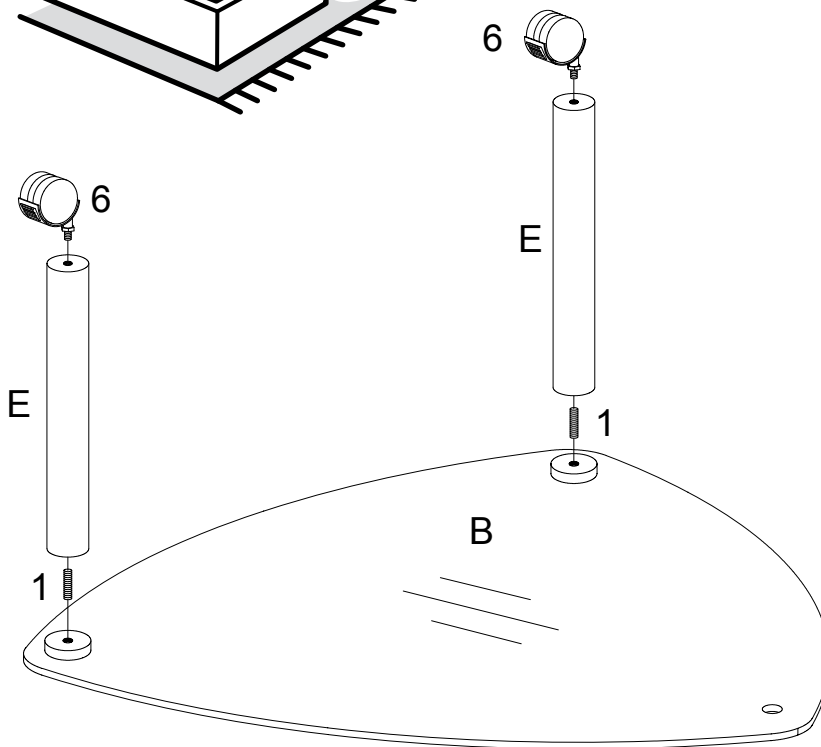
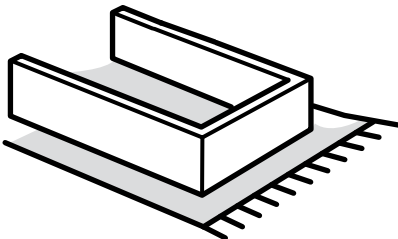

6	2x
	
Ø 5/16" * 50MM	

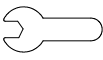
5	1x
	
12MM	

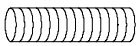
1	5x
	
Ø 5/16" * 35MM	

Schritt 3

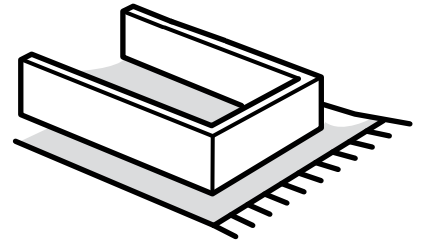

4	1x
Φ21*14MM	

3	2x
Φ50*1.5MM	

1	5x
Ø5/16**35MM	

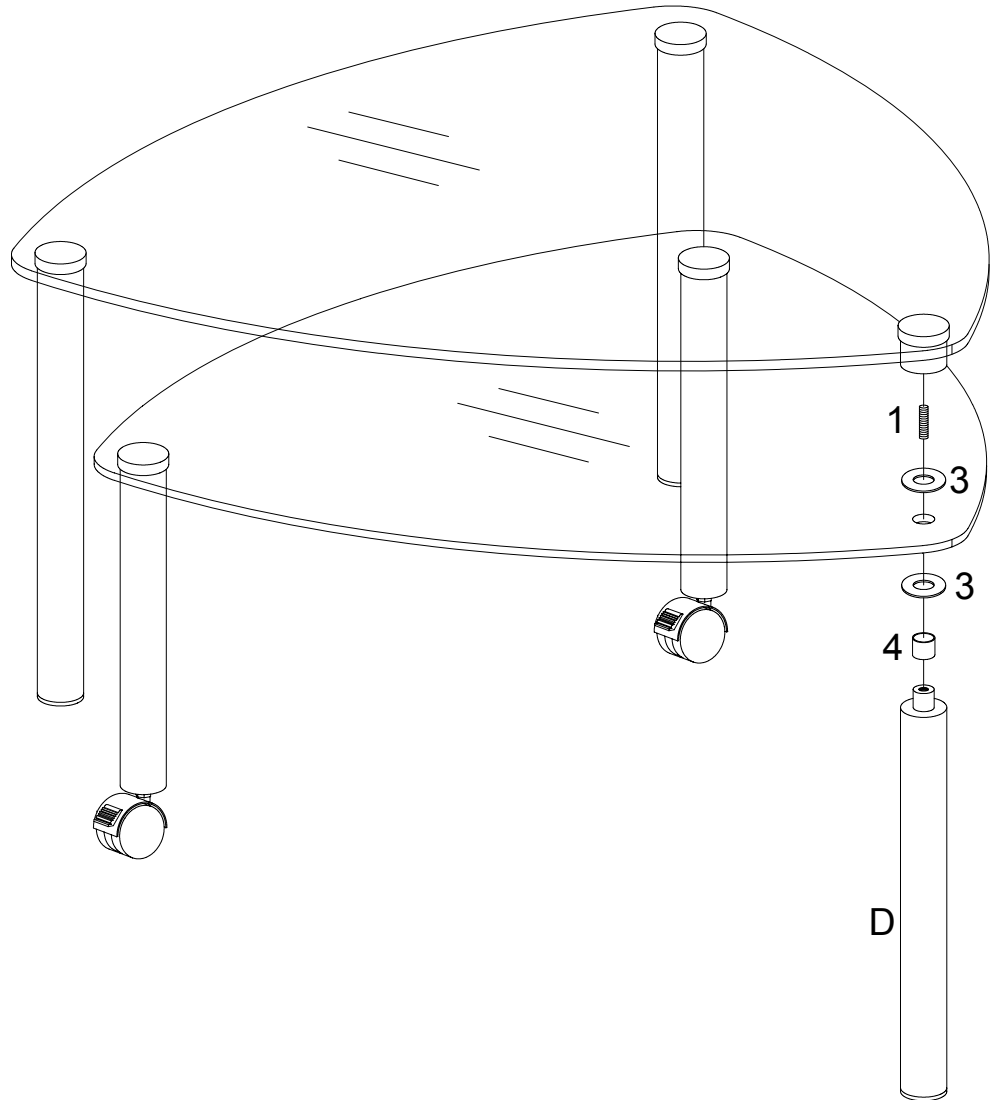

- Nicht an der oberen platte anheben
- Do not lift on the upper plate
- Ne pas soulever sur la plaque supérieure
- Non sollevare sulla piastra superior
- Til niet op de bovenste plaat
- Nie podnoś na górnej płycie
- Nezvedejte na horní desku
- Nezvyšujte hornú dosku
- Ne emelje fel a felső lemezt
- Nu ridicăți placa superioară
- Üst plaka üzerinde kaldırmayın
- Не поднимать верхнюю пластину