

Lotus



D Montageanleitung

GB Assembly instructions

FR Notice de montage

NL Handleiding voor de montage

CZ Montážní návod

IT Istruzioni di montaggio

RO Instrucțiuni de montaj

RU инструкция по сборке

PL Instrukcja montażu

SK Návod na montáž

HU Szerelési útmutató

TR Montaj talimatı

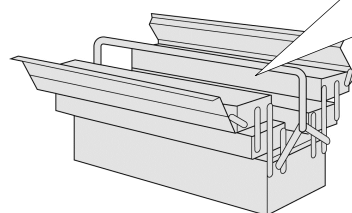
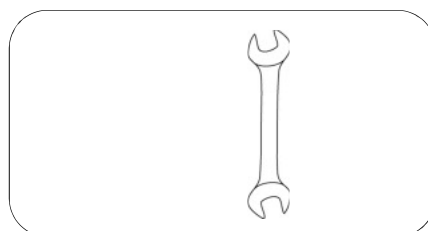
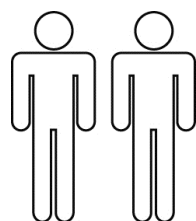
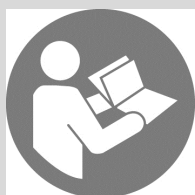

0
10
20
30
40
50
60
70
80
90
100
110
120
130
140
150
160
170
180
190
200

Service • Assistenza • Dienstverlening • Serwis Servis • Szerviz • Сервисная служба		
Name • Nom • Nome • Naam Nazwa • Jméno • Názov • Név Denumire • İsim • Название	Lotus EB	
Nr. • No. • N° • Номер • Č • Sz	SH55	
Typ • Type • Tip • Típus • Тип Тип	OHNE	

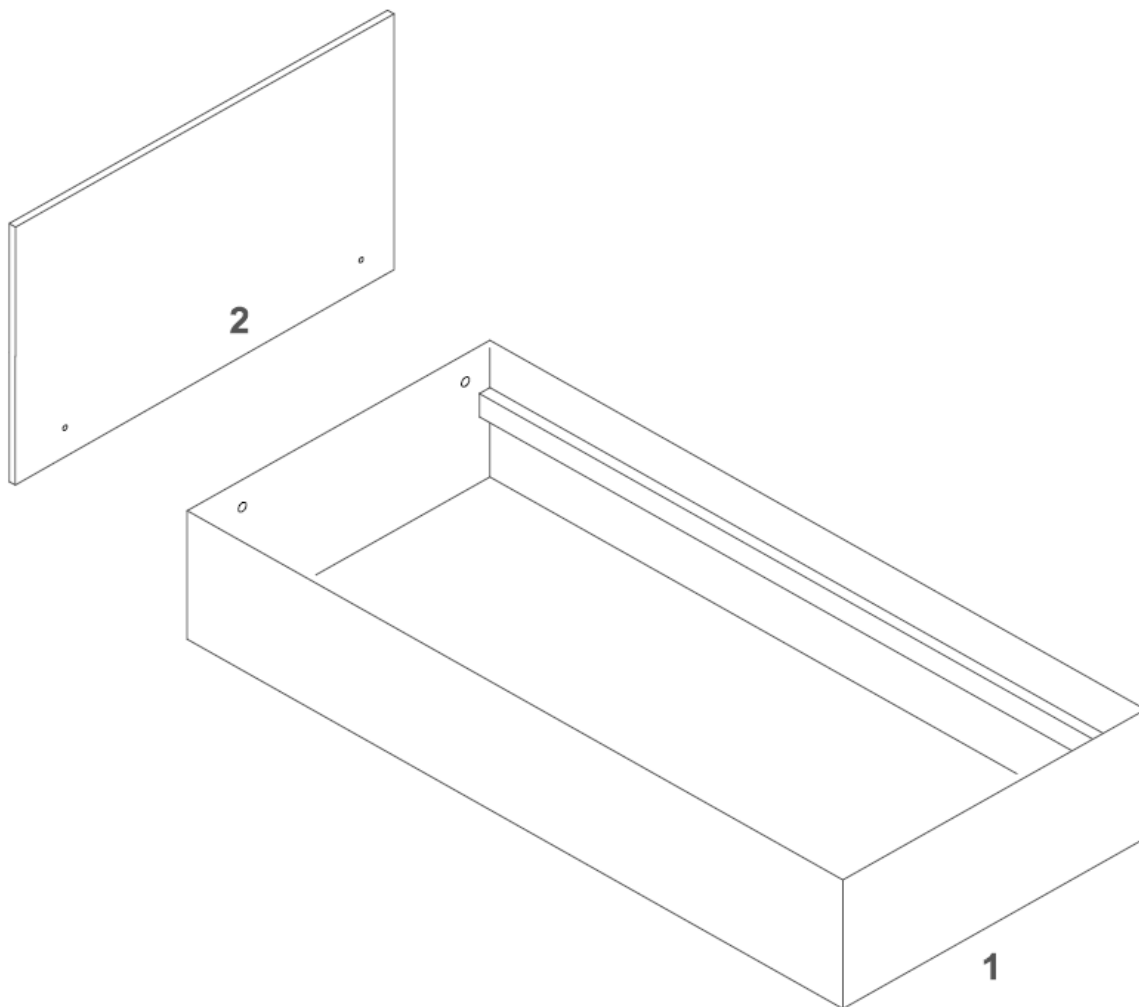

A	B	C	D
4x	4x 8x60	4x M8	4x M8

0
10
20
30
40
50
60
70
80
90
100
110
120
130
140
150
160
170
180
190
200

Service • Assistenza • Dienstverlening • Serwis Servis • Szerviz • Сервисная служба	
Name • Nom • Nome • Naam Nazwa • Jméno • Názov • Név Denumire • İsim • Название	Lotus EB
Nr. • No. • N° • Номер • Č • Sz	SH55
Typ • Type • Tip • Típus • Tipo Тип	LARO

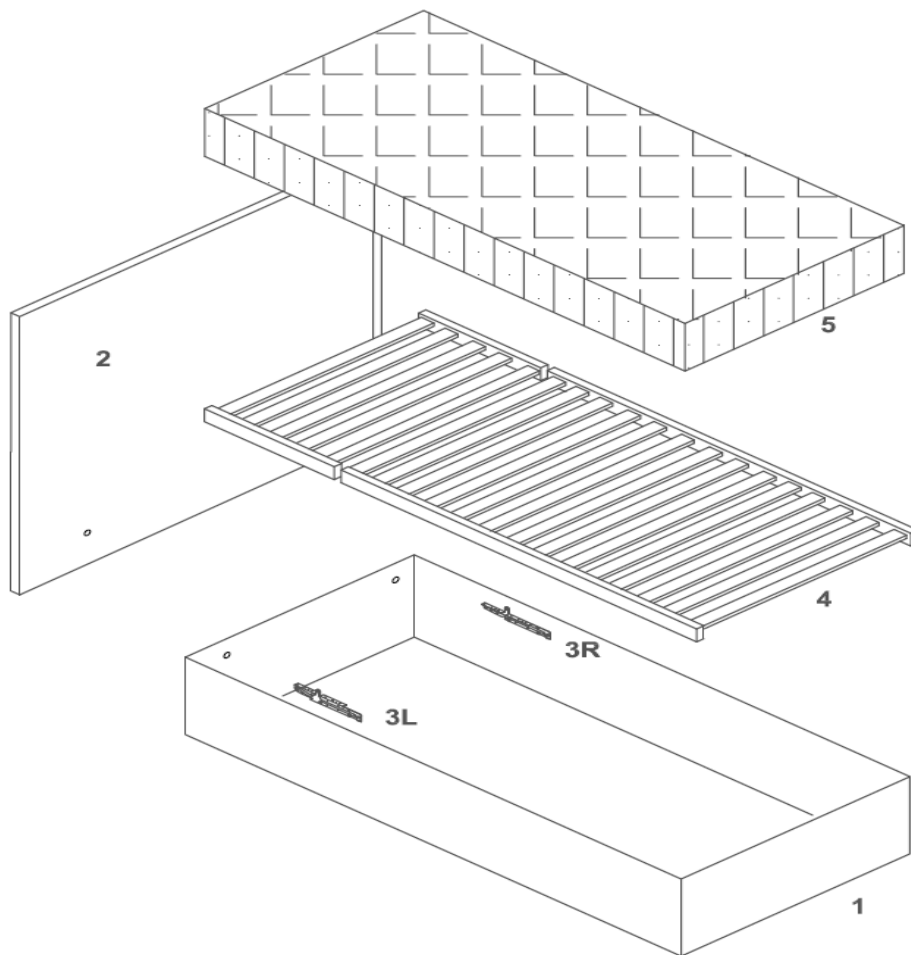

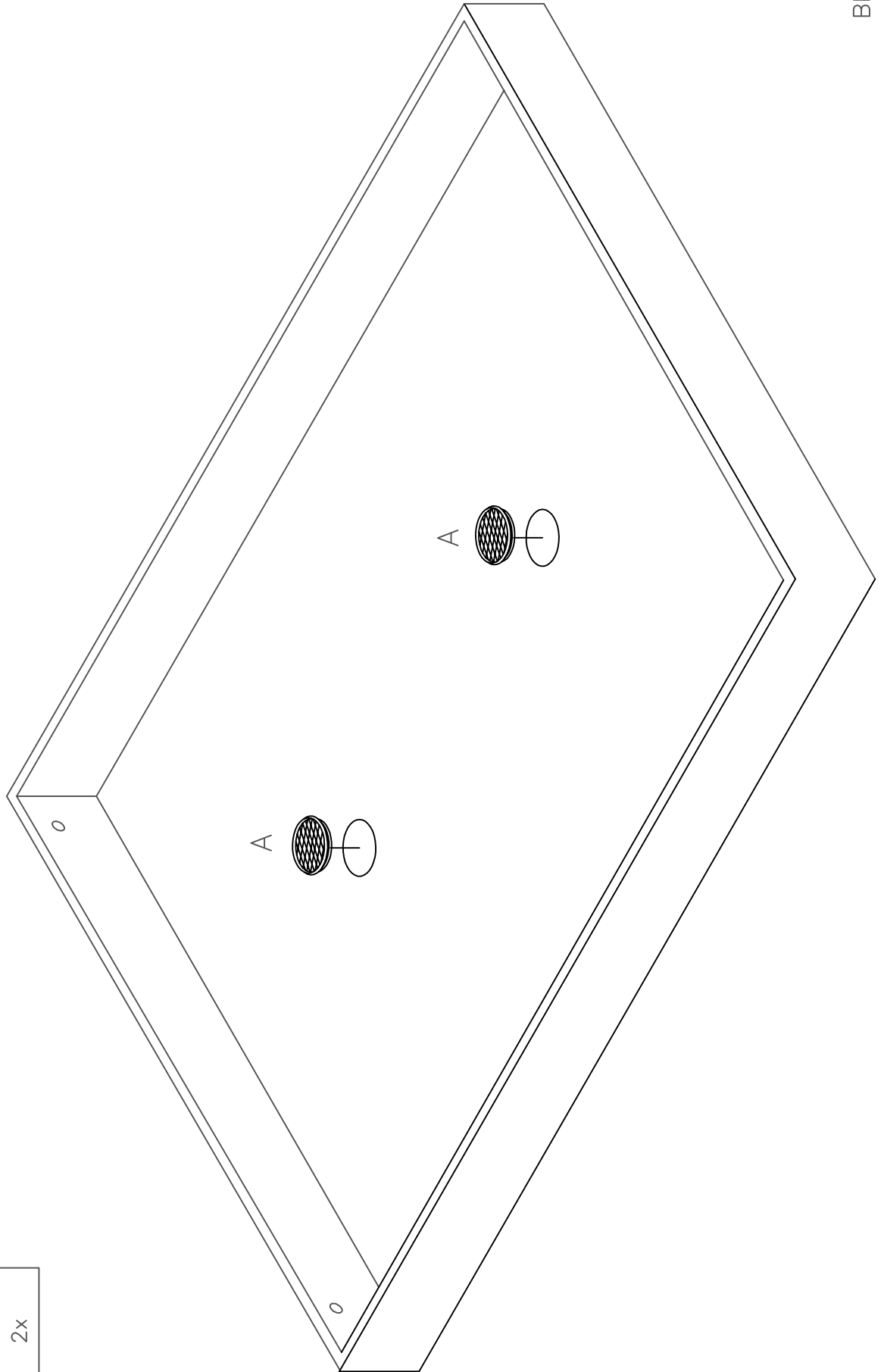

A	B	C	D
4x	4x 8x60	4x M8	4x M8



A		2x
---	--	----

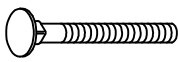

<p>B</p>  <p>4x 8x60</p>	<p>C</p>  <p>4x 8x40</p>	<p>D</p>  <p>4x M8</p>	<p>Achtung! Schrauben nicht überdrehen FR Attention! Ne serrez pas trop CZ Dávej Pozor! Nepřetahujte RO Ai Grija! Nu strângeți PL Uwaga! Nie dokręcać zbyt mocno HU Vigyázz! Ne húzza túl</p> <p>GB Watch Out! Do not over tighten NL Let Op! Niet te vast IT Atteno! Non stringere RU Осторожно! Не затягивайте SK Dávaj Pozor! Nepret'ahujte TR Dikkat! Üzerinde sıkmayın</p>
---	---	---	---

