



D Montageanleitung

F Notice de montage

NL Handleiding voor de montage

CZ Monzáni návod

HU Szereelési útmutató

TR Montaj talimatı

GB Assembly instructions

I Istruzione di montaggio

PL Instrukcja montaży

SK Návod na montáž

RO Instrucțiuni de montaj

RU ИНСТРУКЦИЯ ПО МОНТАЖУ

Art. Nr. 3140

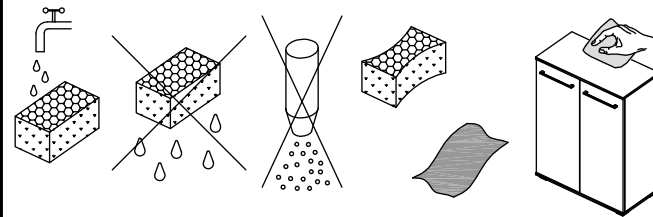
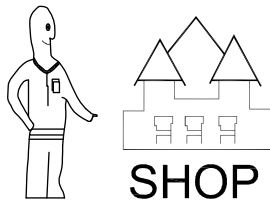
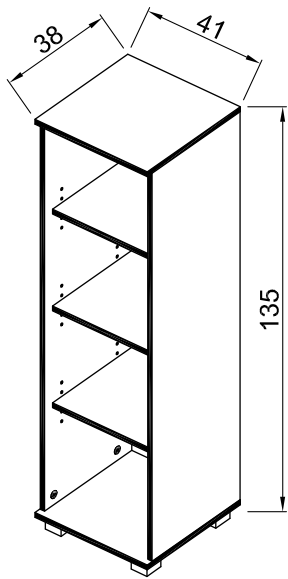

Art. Nr. 3140

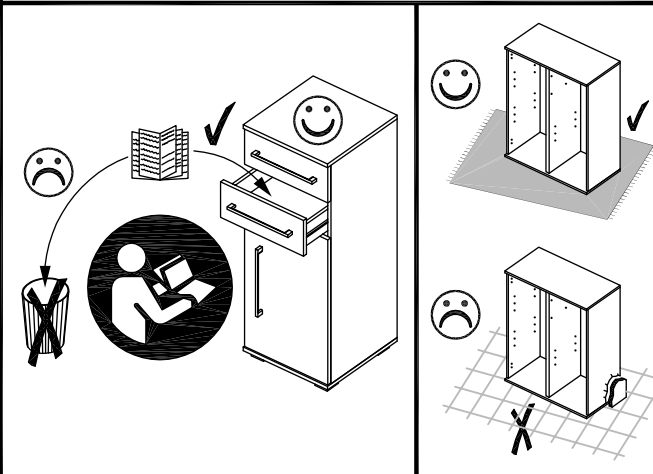
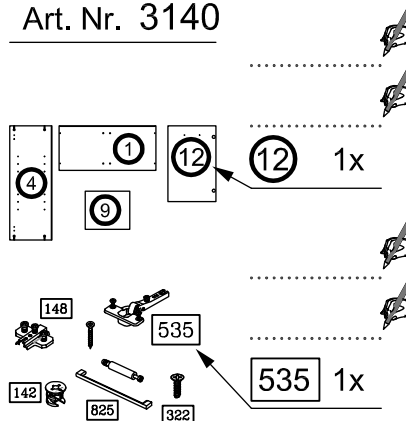

 3,5 x 35 102 8x	 Ø 15 x 11,5 142 8x
 6 x 44 143 8x	 528 4x
 2,7 x 20 906 32x	 916 12x

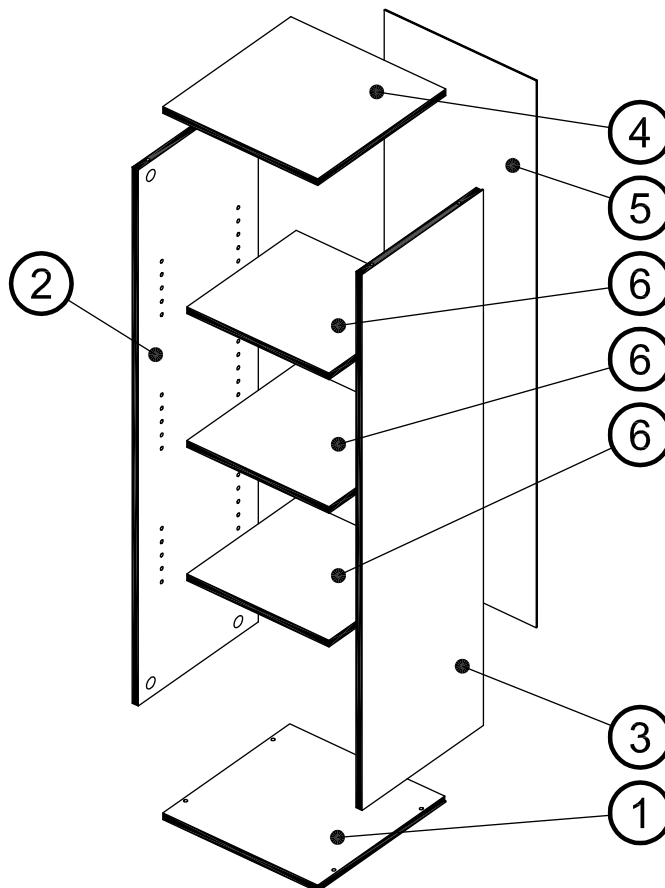

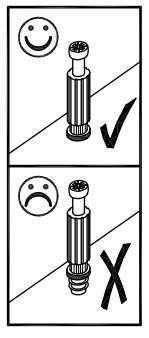
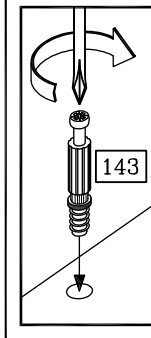
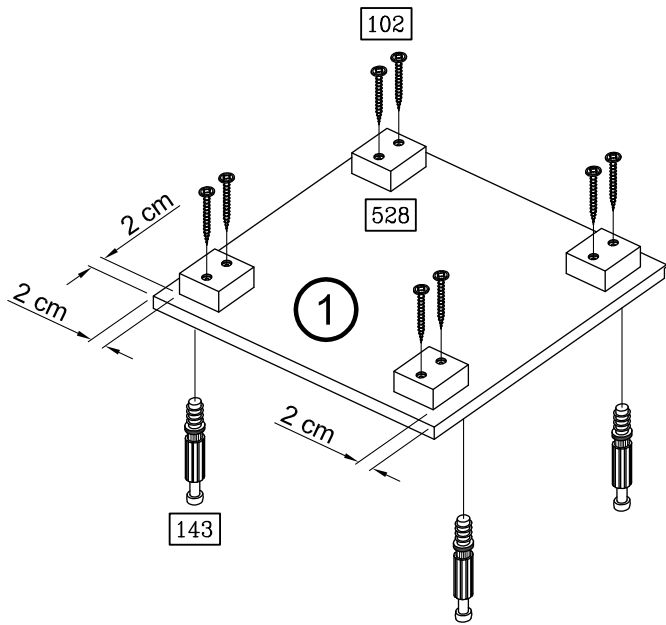
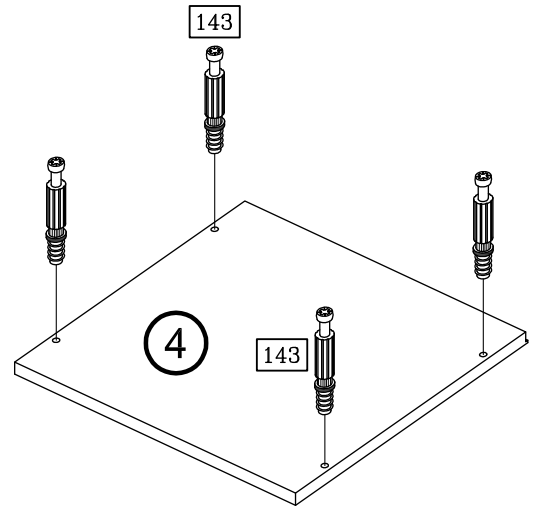
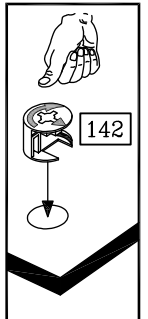
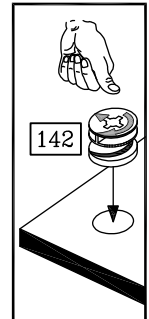
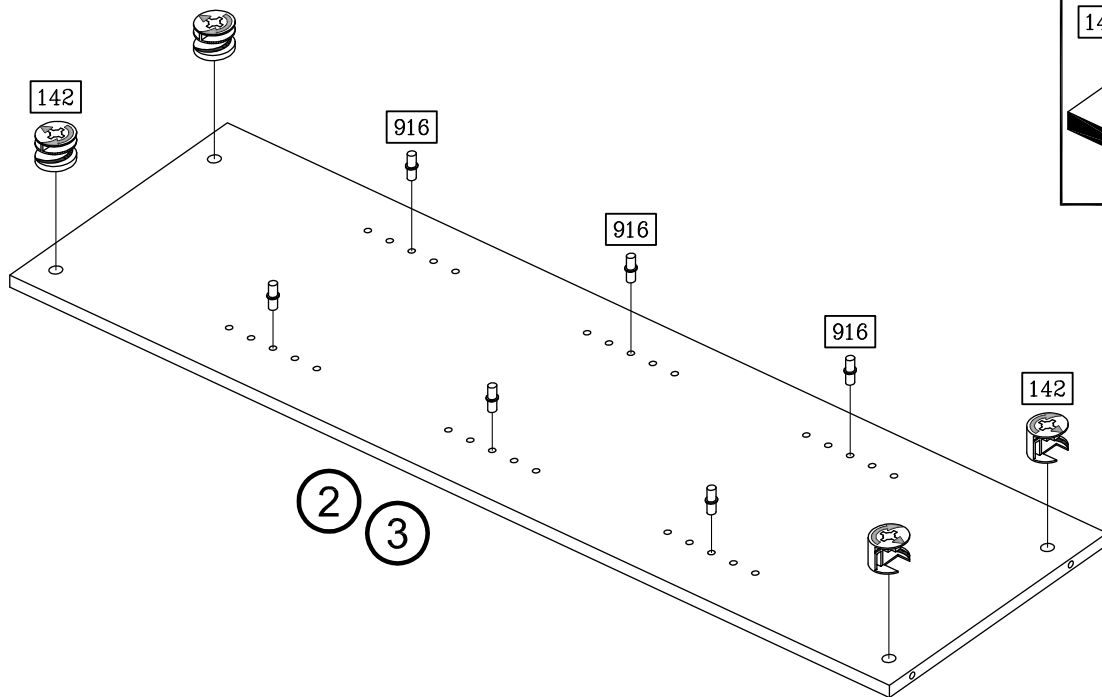
1**2****3**

3140-1211

2/4

4

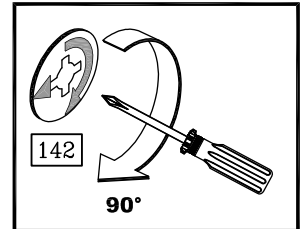
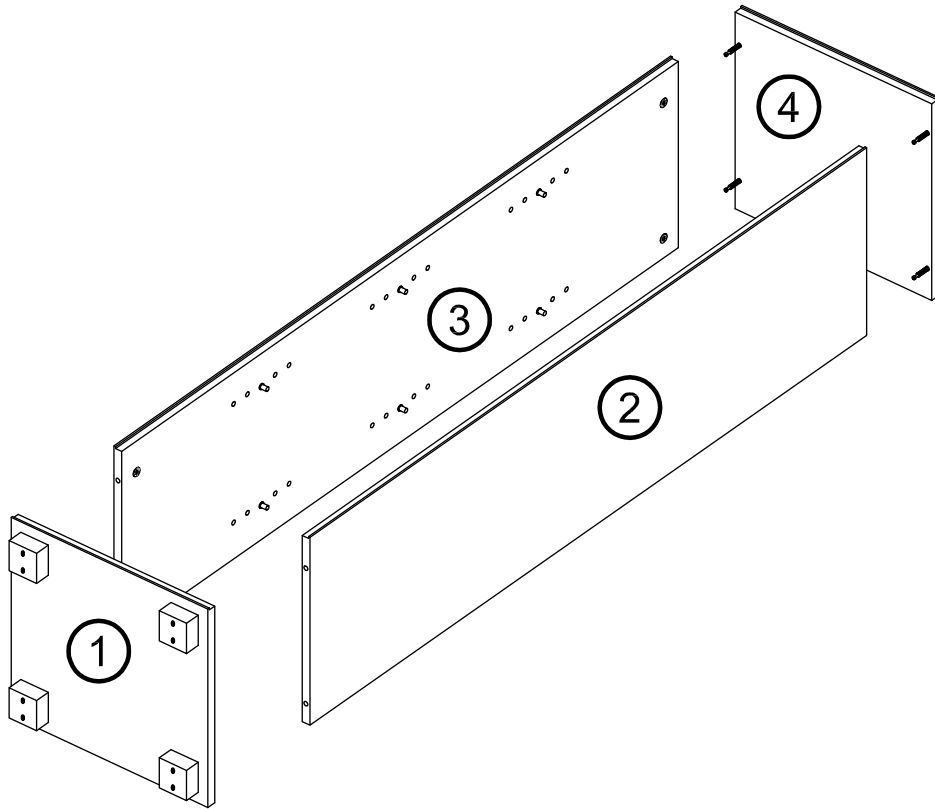

5

