

Modell 11680004/02

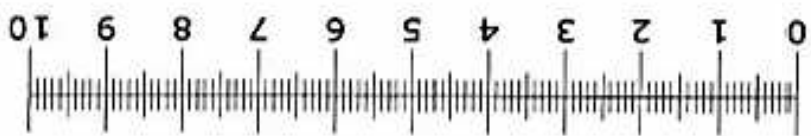

- (D) Montageanleitung
- (NL) Handleiding voor de montage
- (TR) Montaj talimatı
- (GB) Assembly instructions
- (PL) Instrukcja montażu
- (RU) ИНСТРУКЦИЯ ПО МОНТАЖУ

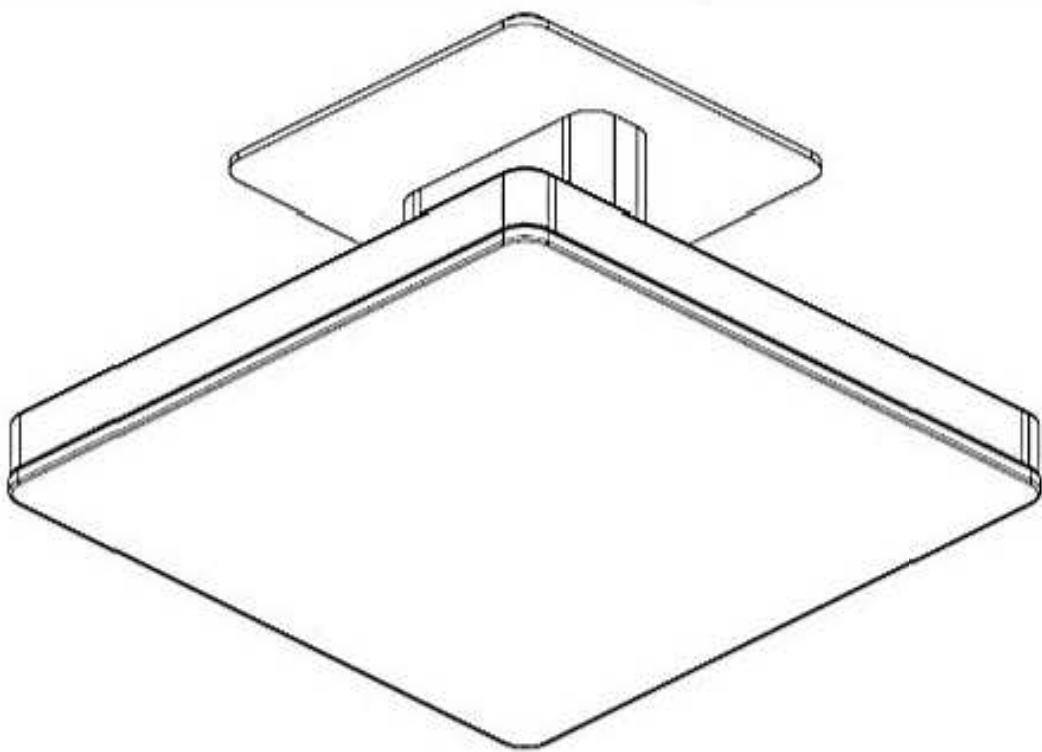
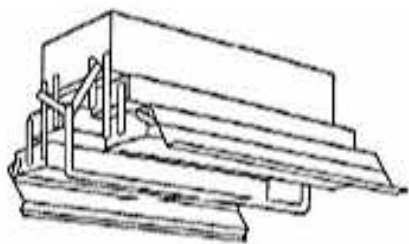
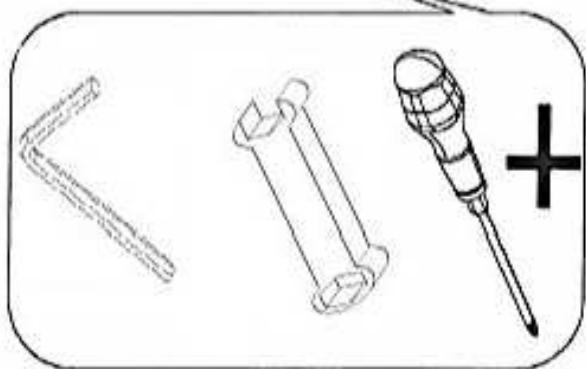

1/6

30 min



Achtung
 bei Modell Rondo
 wird nicht benötigt

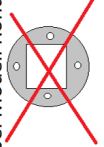
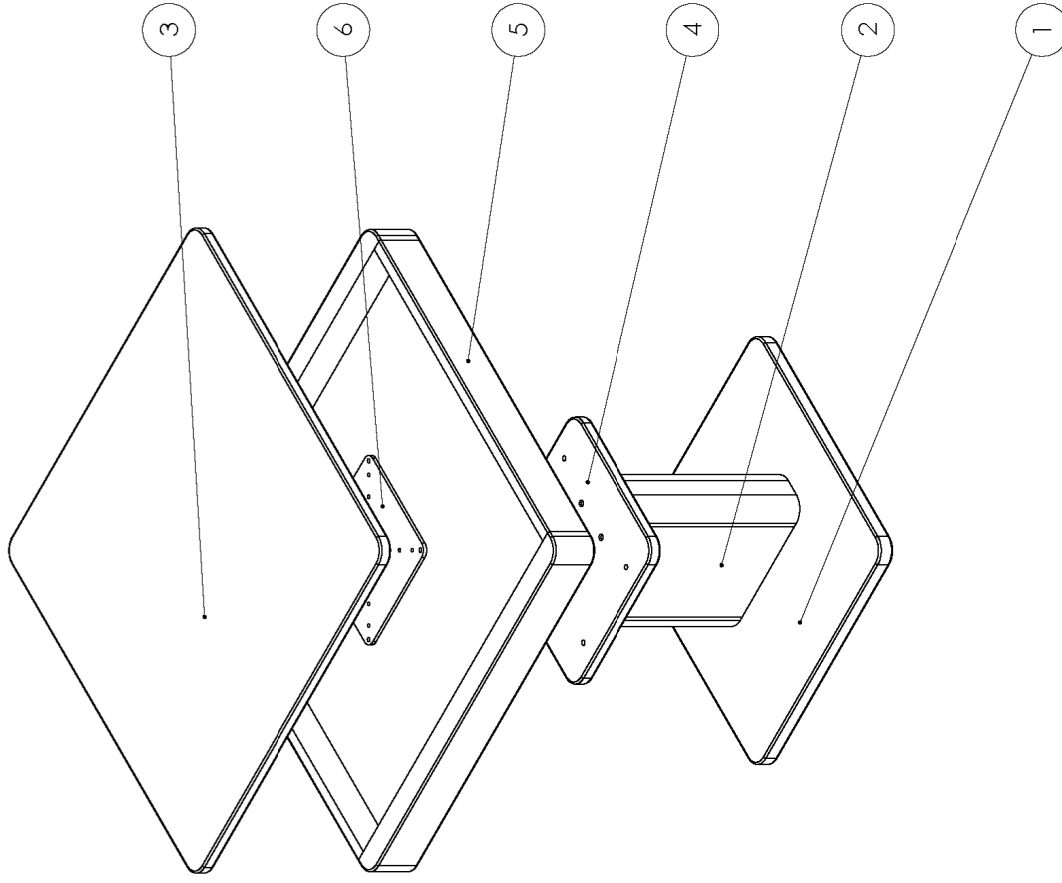
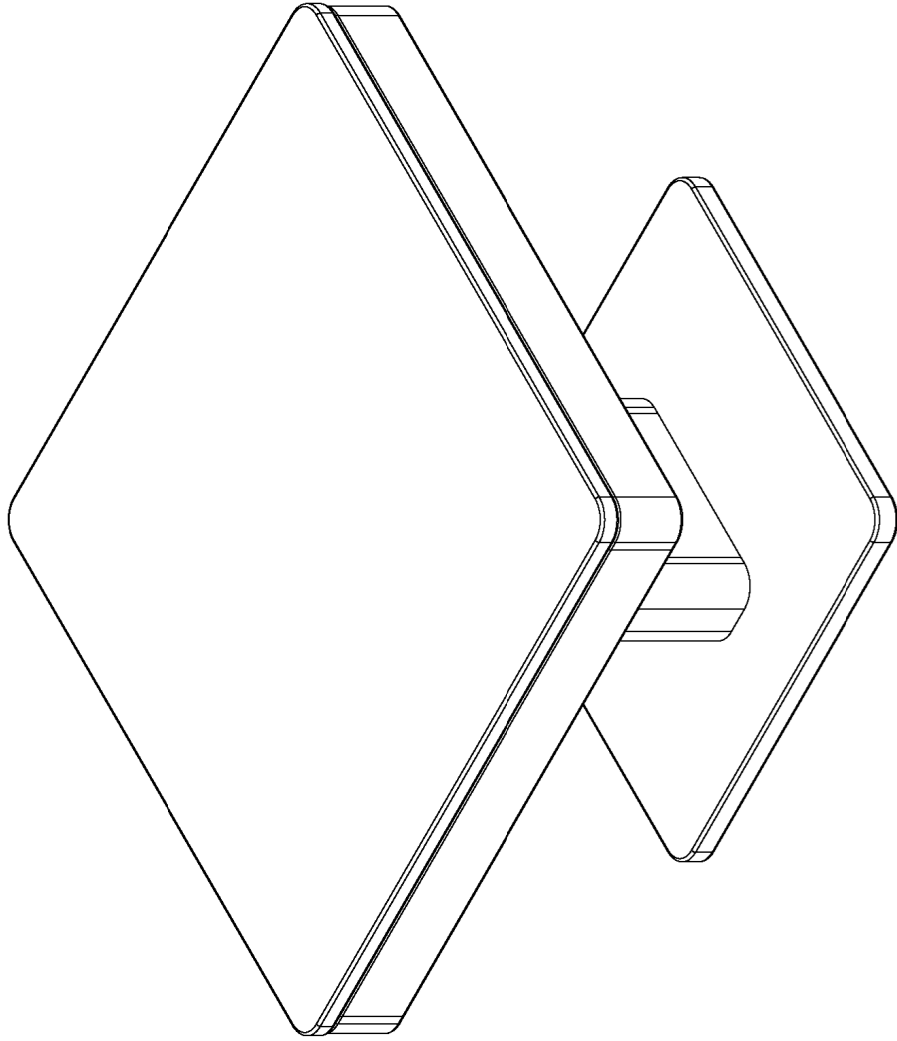









Item No	Part Number	Description HxBxT	COLLI
1	1 x	470x470x25	1/2
2	1 x	315x266x90	2/2
3	1 x	700x700x20	1/2
4	1 x	300x300x20	1/2
5	1 x	695x695x75	1/2
6	1 x	587.50x209x209	2/2







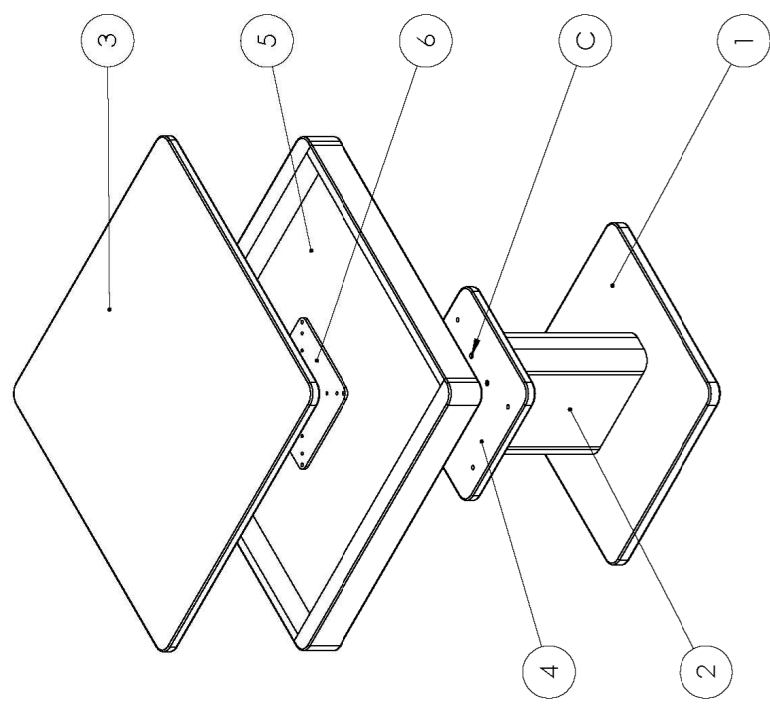
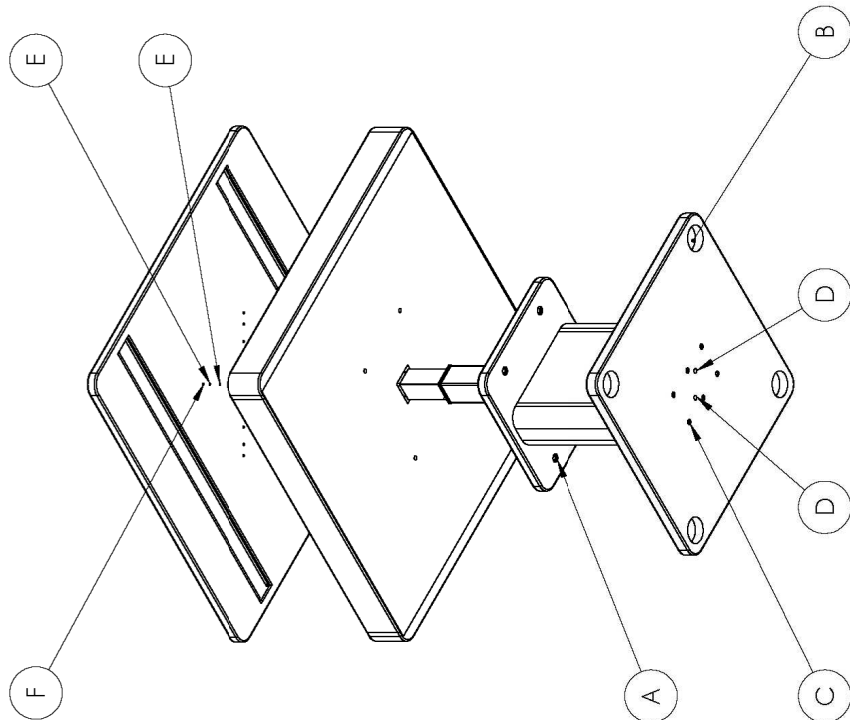

11680004/01

Rondo

2/6

<p>A</p>  <p>M6x30 Kol. 4 kom</p>	<p>D</p>  <p>M8x40 Kol. 2 kom</p>	<p>B</p>  <p>Ø 50x18 Kol. 4 kom</p>	<p>E</p>  <p>Ø 5x20 Kol. 8 kom</p>	<p>C</p>  <p>M7x50 Kol. 12 kom</p>	<p>F</p>  <p>M8x10 Kol. 4 kom</p>	<p>H</p>  <p>Inbus 5 mm Kol. 1 kom</p>
		<p>G</p>  <p>Inbus 4 mm Kol. 1 kom</p>				





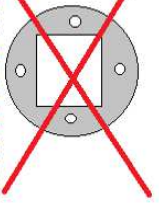

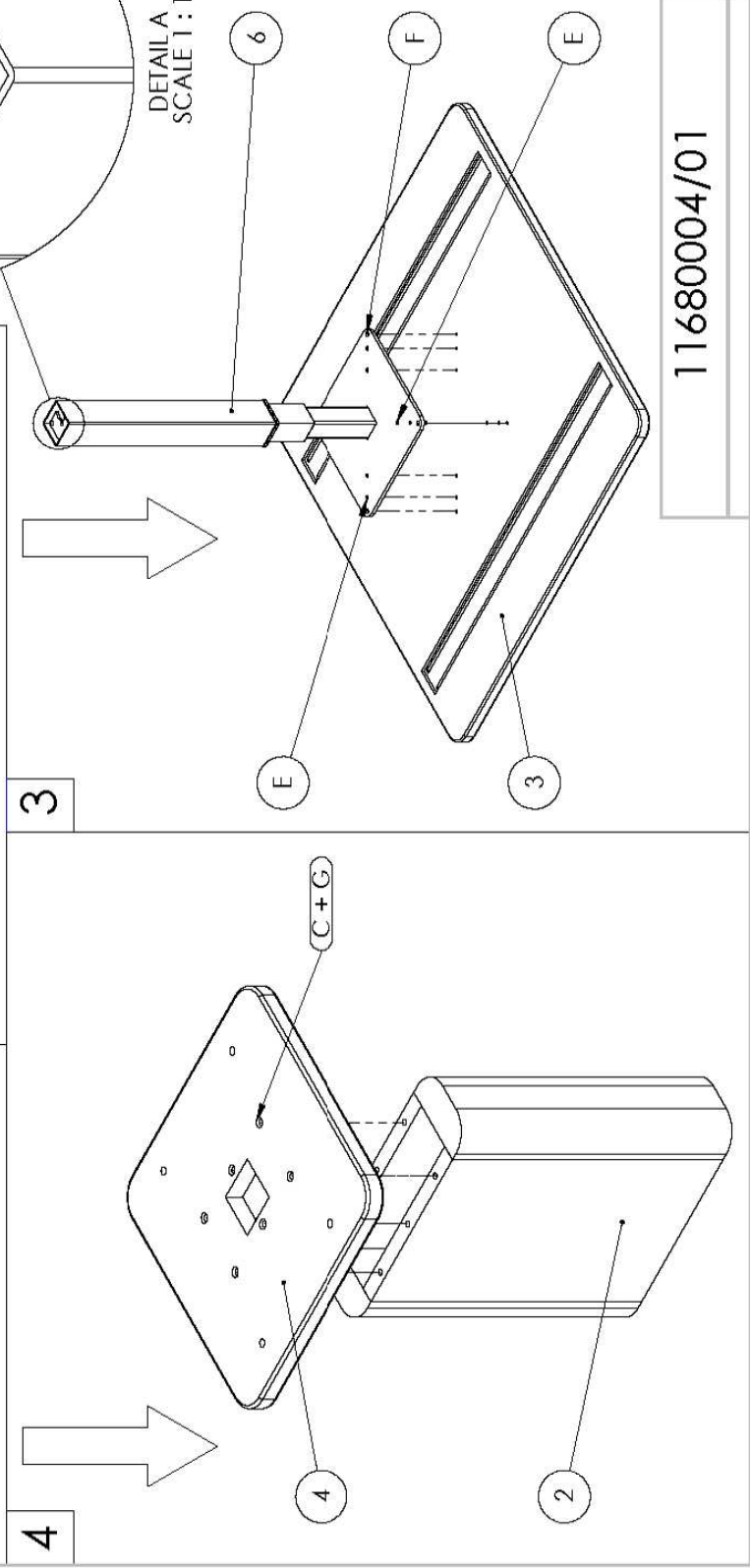
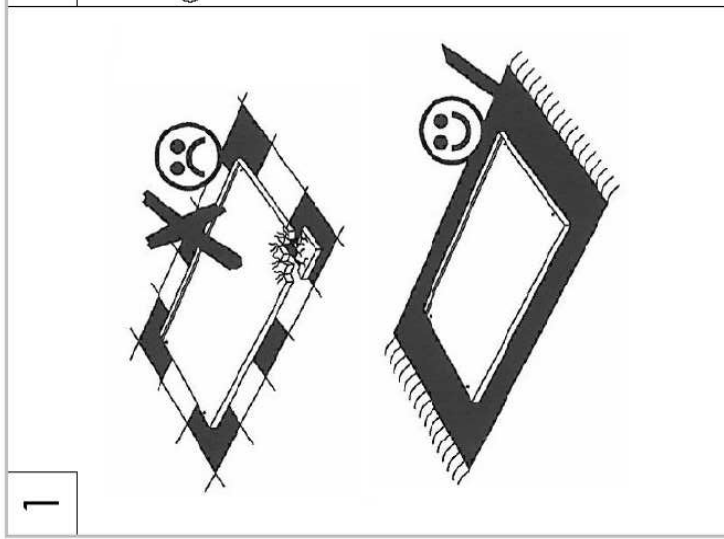
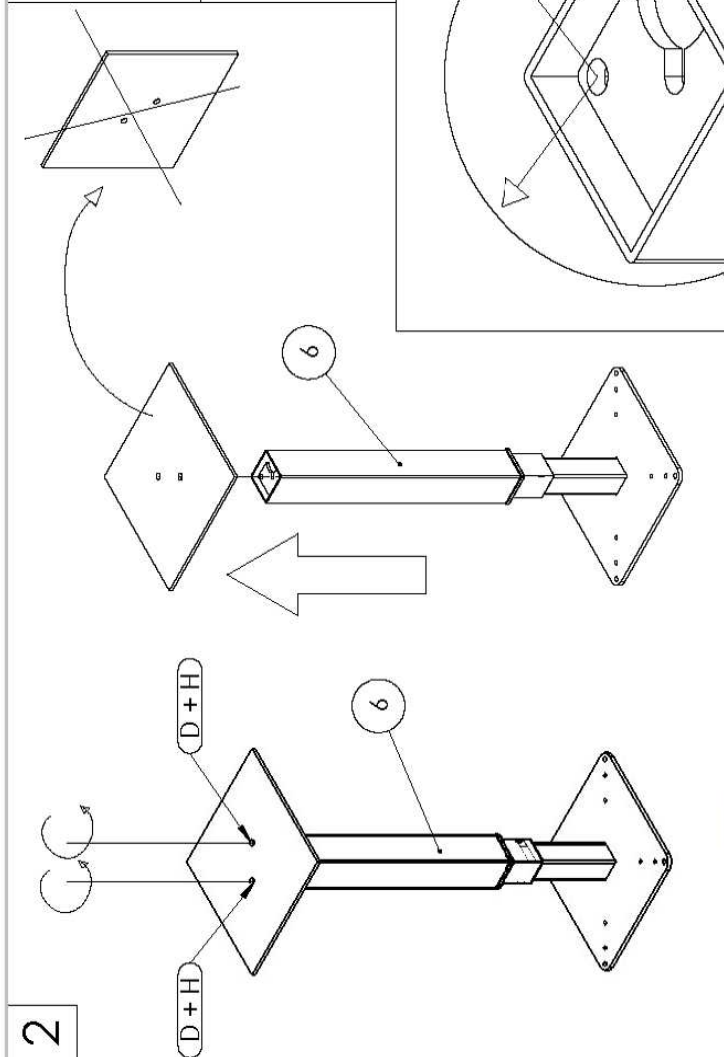



A  M6x30 Kol. 4 kom	B  Ø50x18 Kol. 4 kom	C  M7x50 Kol. 12 kom
D  M8x40 Kol. 2 kom	E  Ø5x20 Kol. 8 kom	F  M8x10 Kol. 4 kom
G  Inbus 4 mm Kol. 1 kom		
H  Inbus 5 mm Kol. 1 kom		

Achtung
bei Modell Rondo

wird nicht benötigt



DETAILA
SCALE 1:1

A  M6x30 Kol. 4 kom	E  φ 5x20 Kol. 8 kom	B  φ 50x18 Kol. 4 kom	F  M8x10 Kol. 4 kom	C  M7x50 Kol. 12 kom	G  Inbus 4 mm Kol. 1 kom	D  M8x40 Kol. 2 kom	H  Inbus 5 mm Kol. 1 kom
--	--	---	--	--	---	---	---

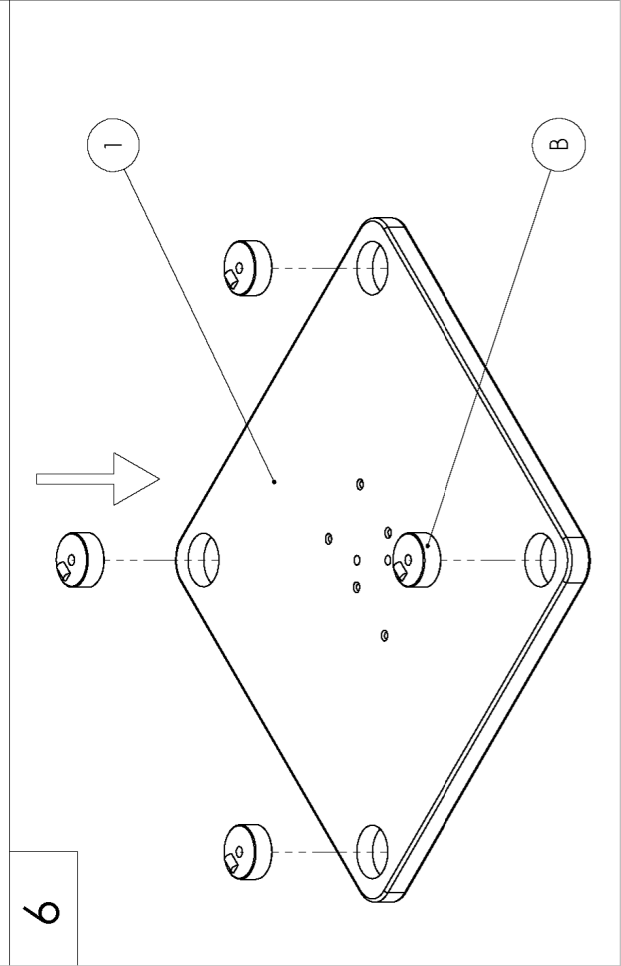
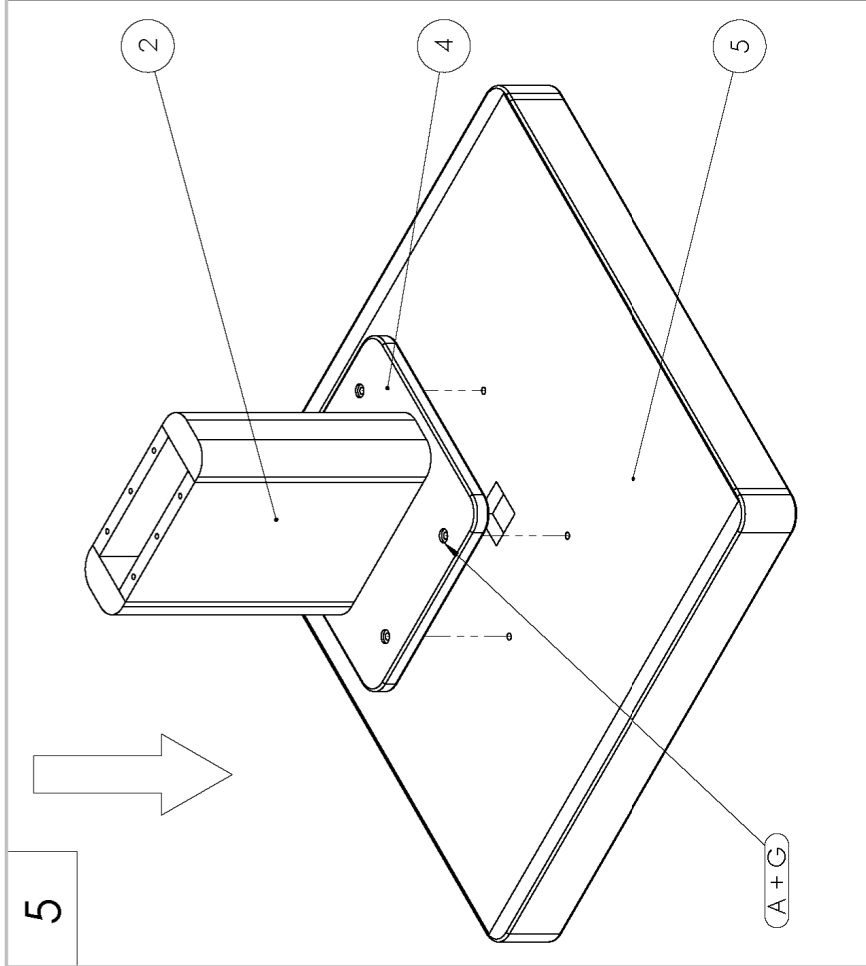
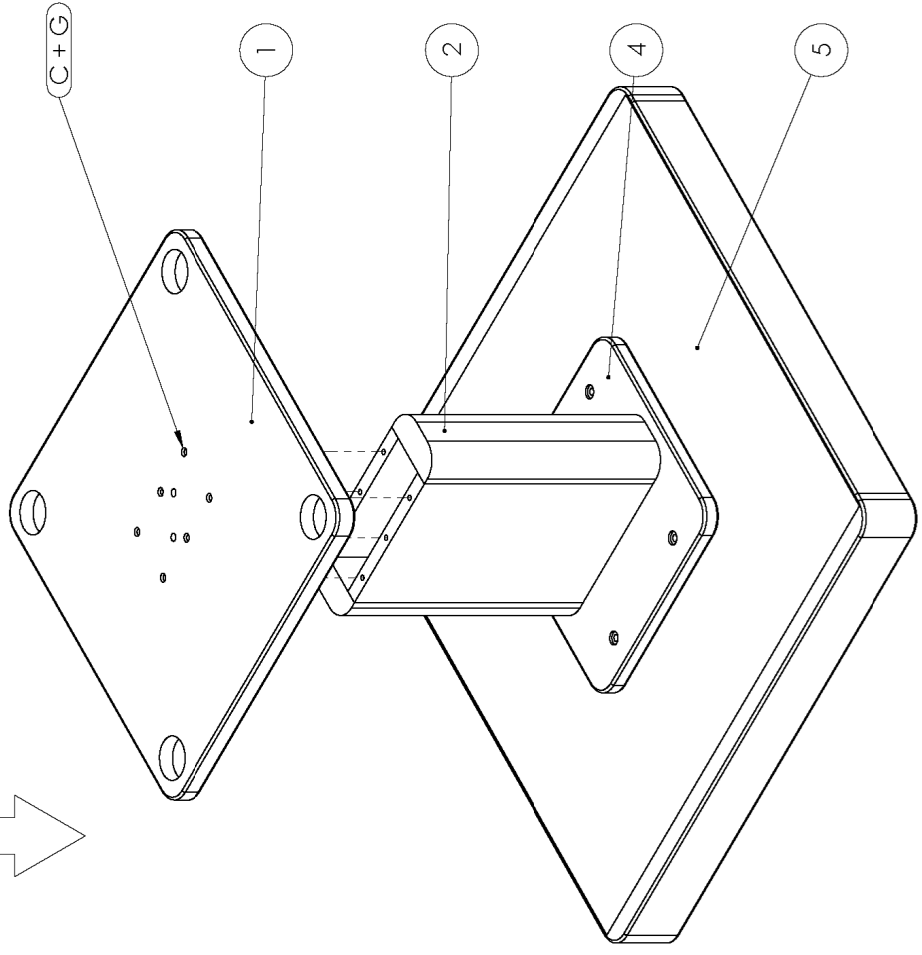
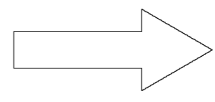
7



11680004/01

Rondo 5/6

8

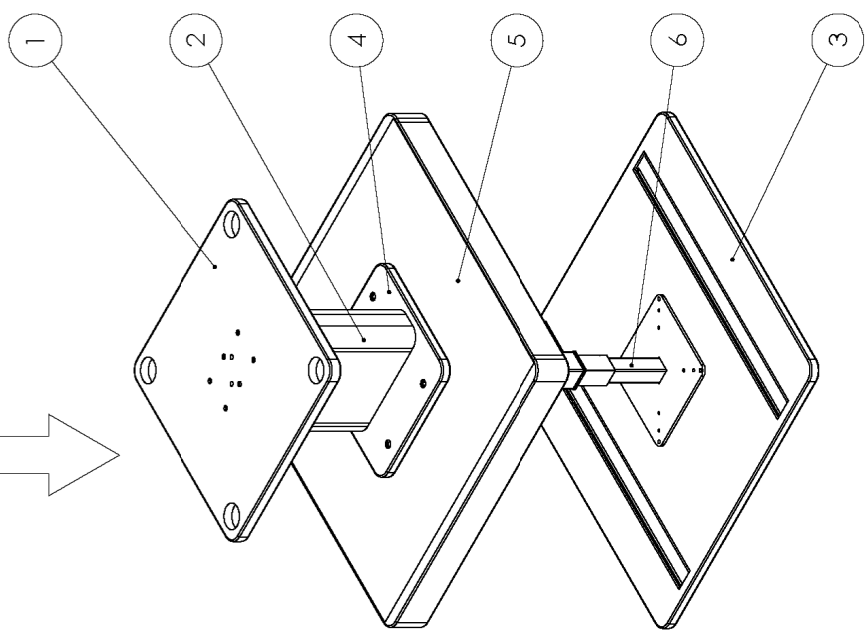
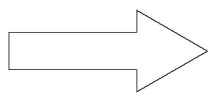

9

- A M6X30 Kol. 4 kom
- B ϕ 50x18 Kol. 4 kom
- C M7x50 Kol. 12 kom
- D M8X40 Kol. 2 kom
- E ϕ 5x20 Kol. 8 kom
- F M8x10 Kol. 4 kom
- G Inbus 4 mm Kol. 1 kom
- H Inbus 5 mm Kol. 1 kom

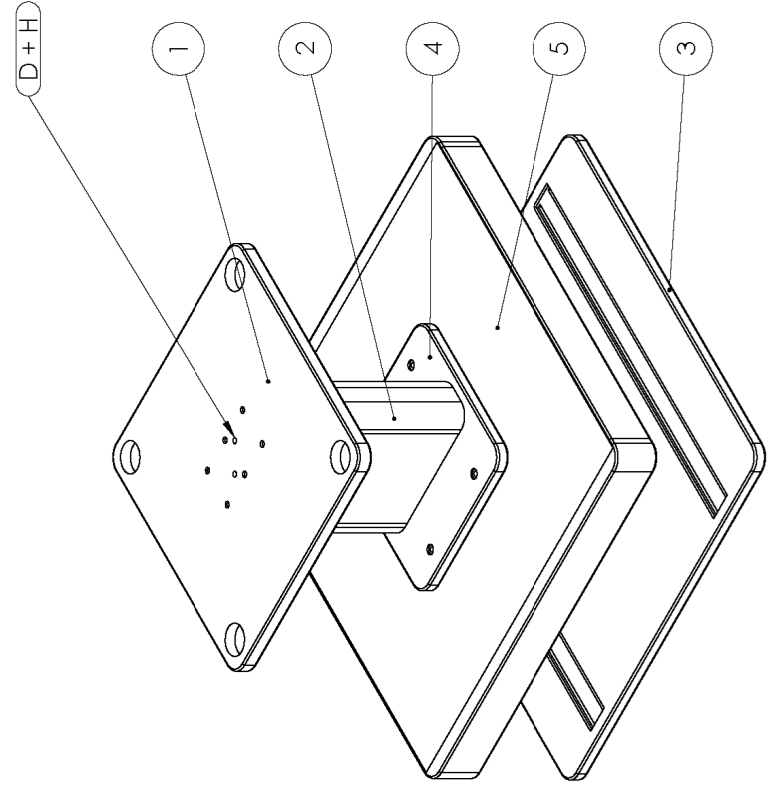

10

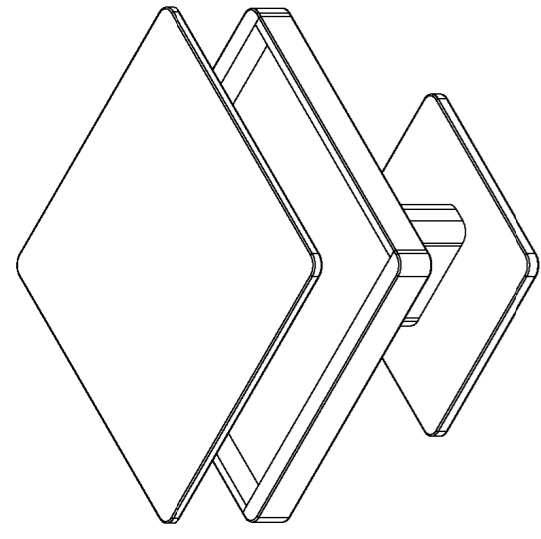
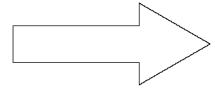

11680004/01

Rondo

6/6