

BIRKHOLM V  
8141/2000/8300  
8100/2000/8142

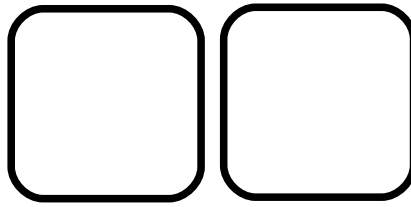

220406

- |           |  |           |   |
|-----------|--|-----------|---|
| <b>D</b>  | MONTAGEANLEITUNG<br>BEDIENUNGSANLEITUNG                | <b>GB</b> | ASSEMBLY INSTRUCTIONS<br>INSTRUCTION MANUAL         |
| <b>NL</b> | HANDLEIDING VOOR DE MONTAGE<br>GEBRUIKSAANWIJZING      | <b>PL</b> | INSTRUKCJA MONTAŻU<br>INSTRUKCJA OBSŁUGI            |
| <b>TR</b> | MONTAJ TALIMATI<br>KULLANIM KLAVUZU                    | <b>RU</b> | ИНСТРУКЦИЯ ПО МОНТАЖУ<br>ИНСТРУКЦИЯ ПО ЭКСПЛУАТАЦИИ |
| <b>RO</b> | INSTRUCȚIUNI DE INSTALARE<br>INSTRUCȚIUNI DE UTILIZARE | <b>IT</b> | ISTRUZIONI DI MONTAGGIO<br>MANUALE DI ISTRUZIONI    |
| <b>FR</b> | NOTICE DE MONTAGE<br>MANUEL INSTRUCTIONS               | <b>SK</b> | MONTÁŽNY NÁVOD<br>NÁVOD NA POUŽITIE                 |
| <b>HU</b> | KÖZGYŰLÉS UTASÍTÁSOK<br>KEZELÉSI UTASÍTÁS              | <b>CZ</b> | MONTÁŽNÍ NÁVOD<br>NÁVOD K POUŽITÍ                   |
| <b>SI</b> | NAVODILA ZA MONTAŽO<br>NAVODILA ZA UPORABO             | <b>PT</b> | INSTRUÇÕES DE MONTAGEM<br>MANUAL DO USUÁRIO         |
| <b>ES</b> | INSTRUCCIONES DE MONTAJE<br>MANUAL DEL USUARIO         | <b>HR</b> | UPUTE ZA MONTAŽU<br>UPUTE ZA UPOTREBU               |



0090

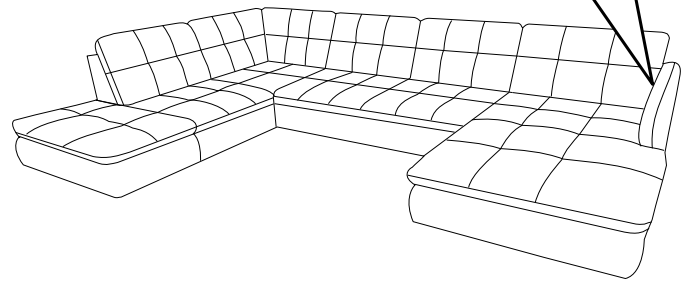
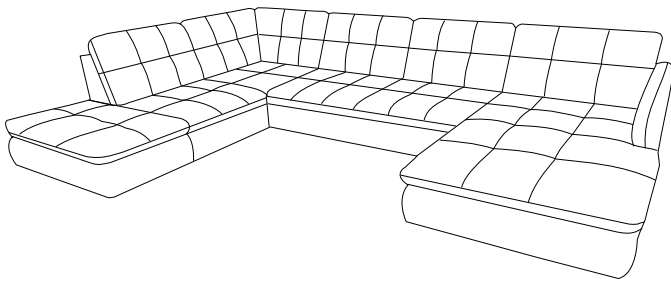
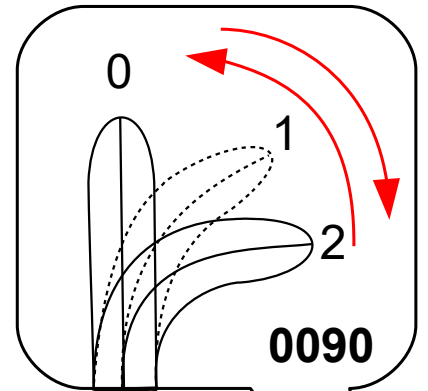



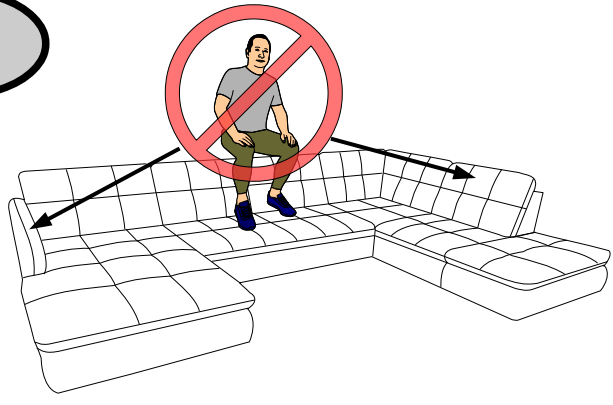

L

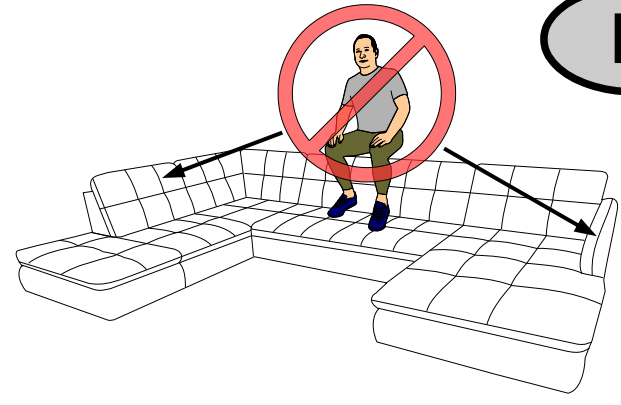





R

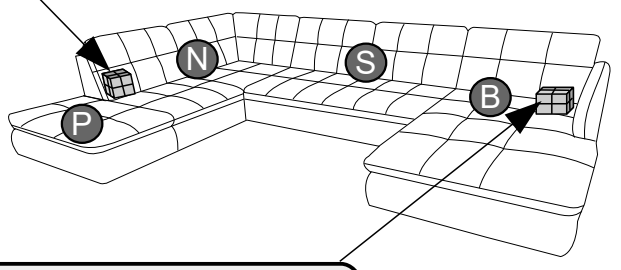
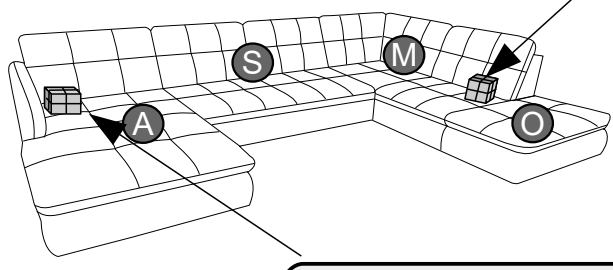





<b>z</b> H-150  X3	<b>m</b> 10x40  X4	<b>y</b> H-150  X4	<b>q</b> M8*30  X16	<b>i</b> L-5 [mm]  X1
---	---	---	--	--

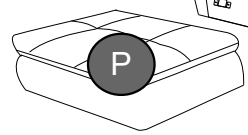
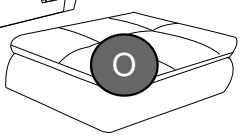
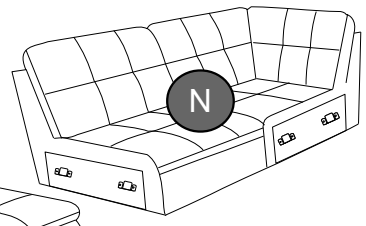
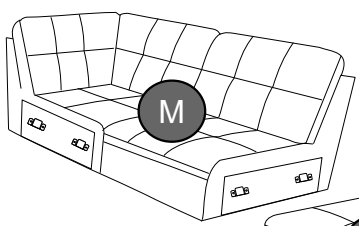
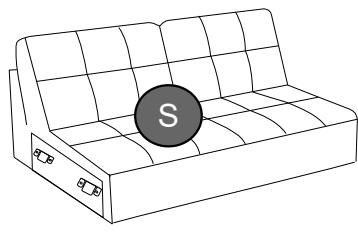
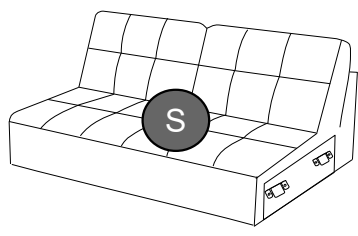
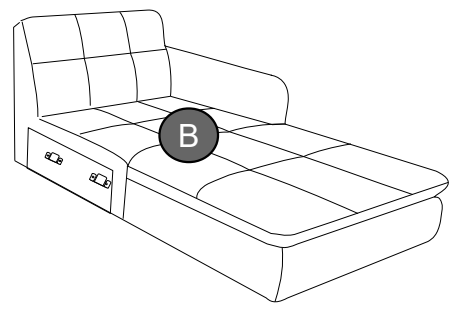
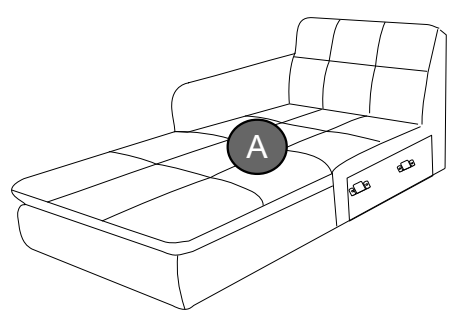

<b>m</b> 10x40  X5	<b>y</b> H-150  X5	<b>z</b> H-150  X1	<b>q</b> M8*30  X20	<b>i</b> L-5  X1
---	---	---	---	---



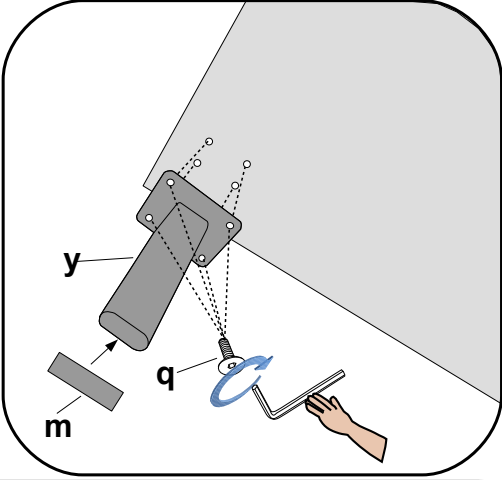
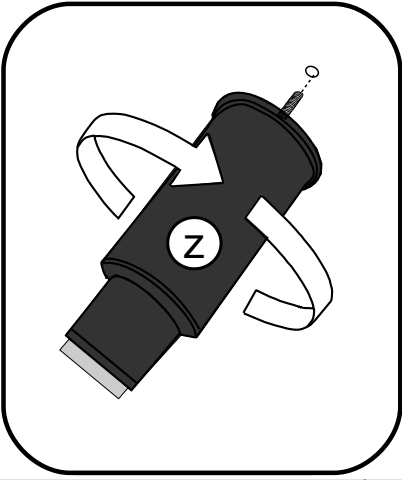
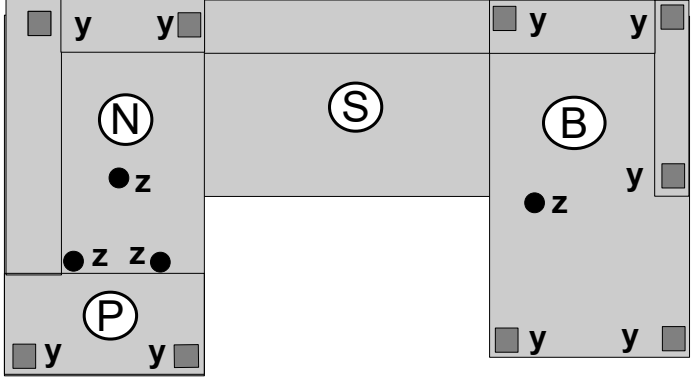
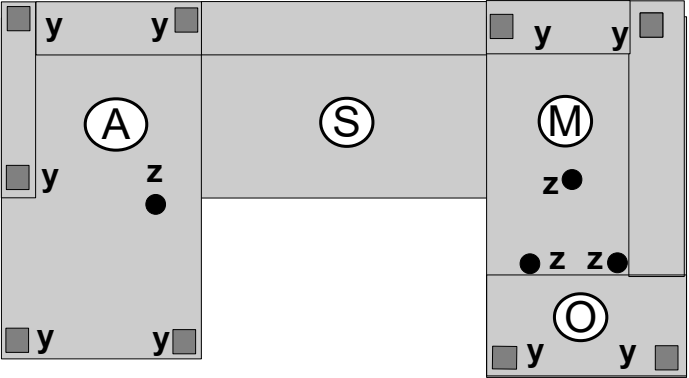
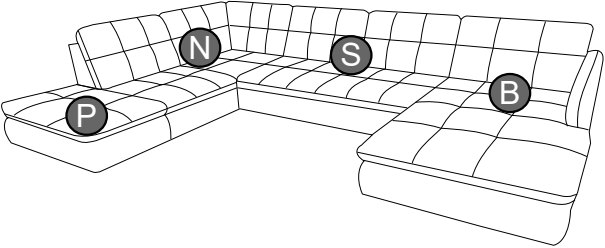
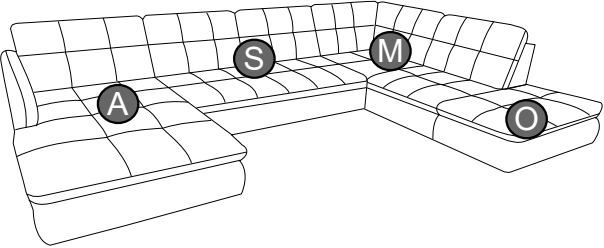

<b>m</b> 10x40 	<b>y</b> H-150 	<b>z</b> H-150 	<b>q</b> M8*30 	<b>i</b> L-5 
X9	X9	X4	X36	X1

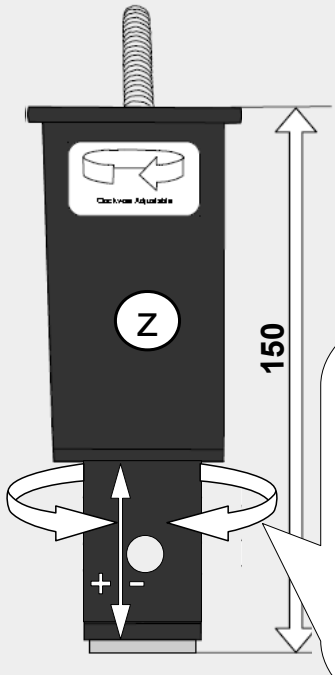

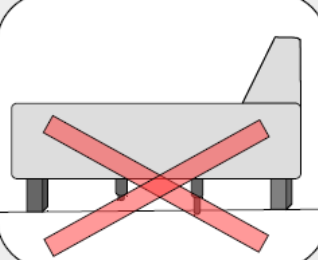

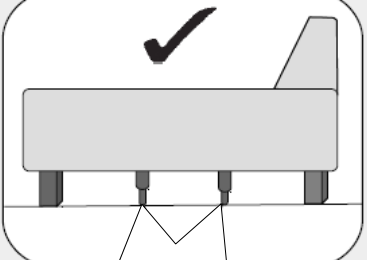





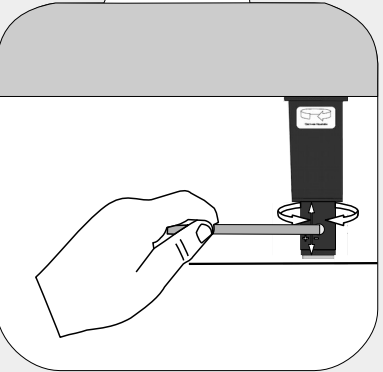

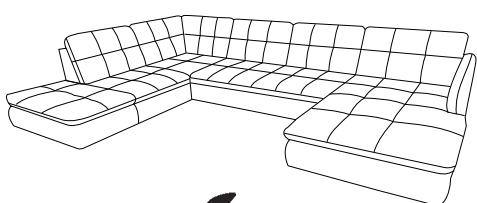
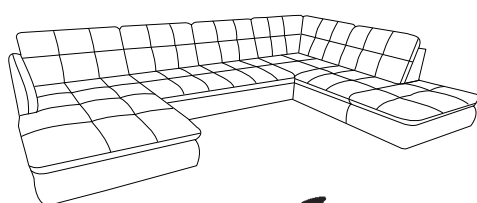
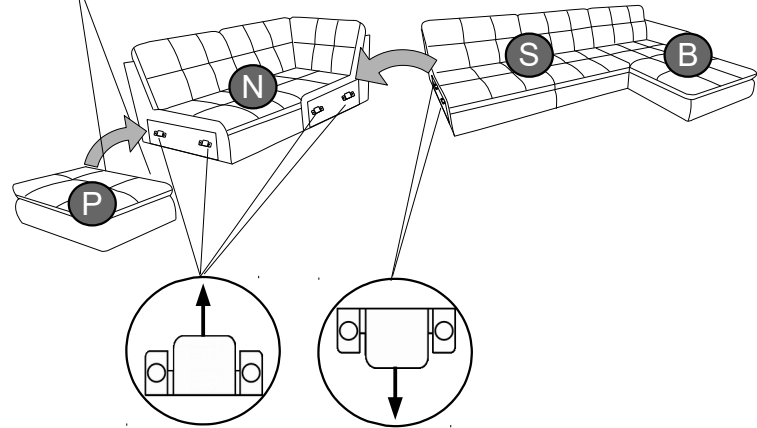
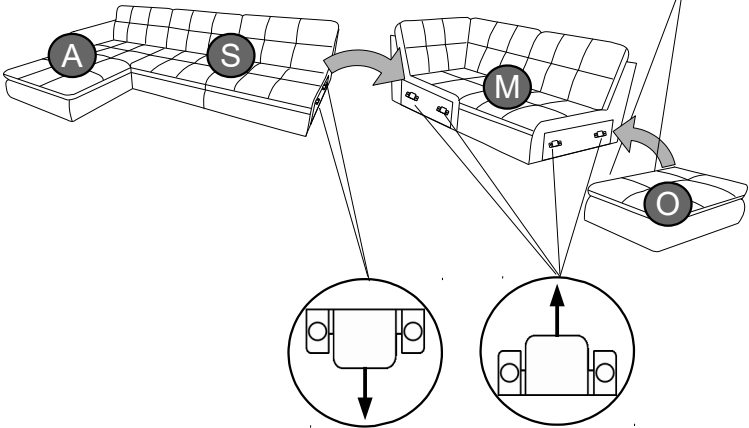
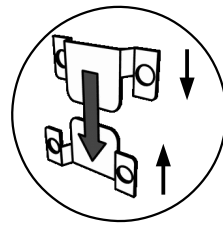
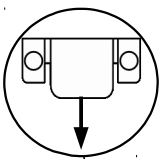
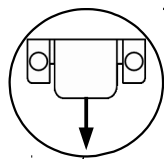
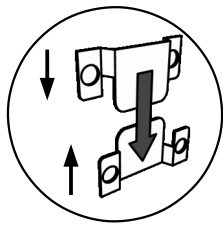
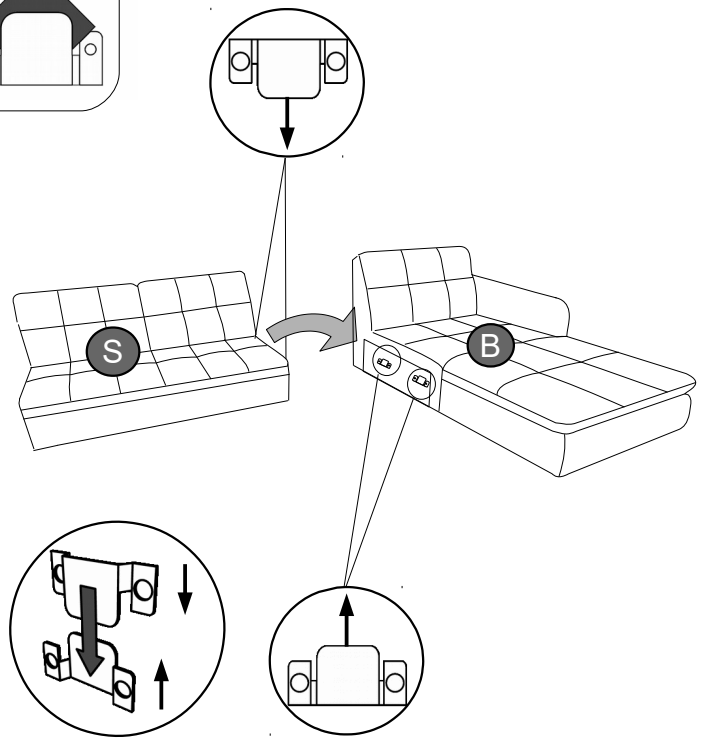
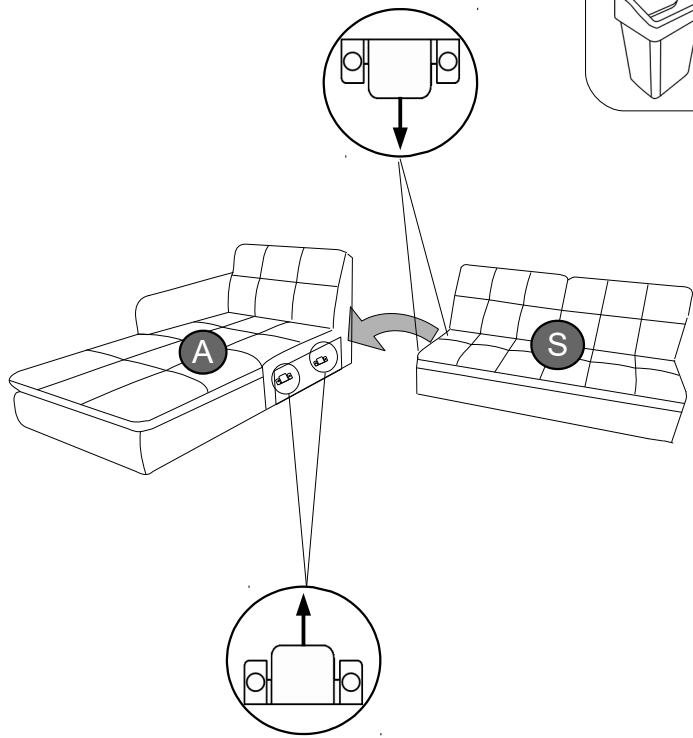
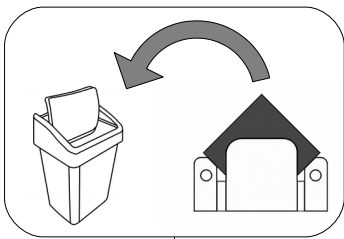

Service · Dienstverlening · Serwis · Servis · Сервисная служба · Serviciu · Services · Servizio  
 ·Servisný list · Szolgáltatás · Servisní list

Name · Naam · Nazwa · İsim · Название · Nume · Nome · Názov · Názov ·  
 Název · Neve  
**BIRKHOLM V**  
 Тип · Type · Tip · Тип · Tipo · Típus

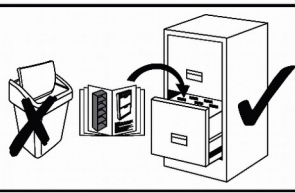
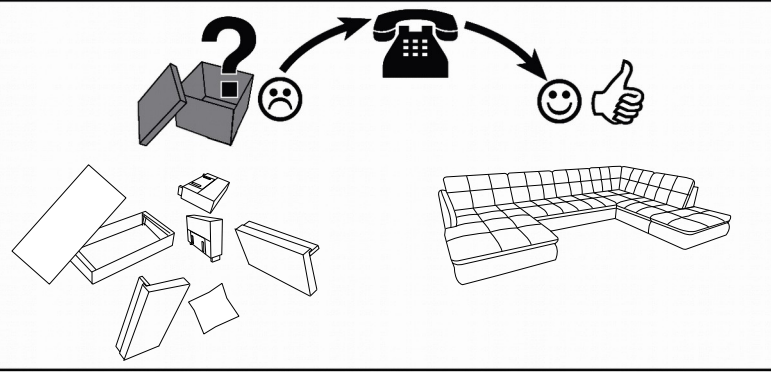



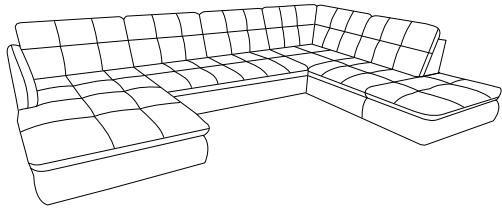

**L**

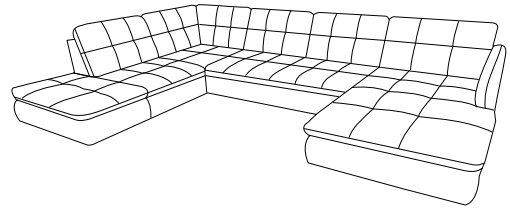

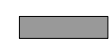
**R**



<b>m</b> 10x40 	<b>y</b> H-150 	<b>z</b> H-150 	<b>q</b> M8*30 	<b>i</b> L-5 [mm] 
---	---	---	---	--

