

**D****Wichtige Pflegehinweise**

Bitte beachten Sie die wichtigen Pflegehinweise auf unserer Internetseite

www.till-hilft.de

Pflegehinweise

**PL****Ważne instrukcje dotyczące pielęgnacji**

Zwróć uwagę na ważną instrukcję dotyczącą pielęgnacji na naszej stronie internetowej

www.till-hilft.de

Pflegehinweise

**GB****Important care instructions**

Please note the important care instructions on our website

www.till-hilft.de

Pflegehinweise

**SK****Dôležité pokyny na starostlivosť**

Dbajte na dôležité pokyny týkajúce sa starostlivosti na našich webových stránkach

www.till-hilft.de

Pflegehinweise

**FR****Instructions d'entretien importantes**

S'il vous plaît noter les instructions de soins importants sur notre site Web

www.till-hilft.de

Pflegehinweise

**HU****Fontos kezelési utasítások**

Kérjük, vegye figyelembe a honlapunkon található fontos kezelési útmutatót

www.till-hilft.de

Pflegehinweise

**IT****Importanti istruzioni per la cura**

Si prega di notare le importanti istruzioni per la cura sul nostro sito web

www.till-hilft.de

Pflegehinweise

**RO****Instrucțiunile importante de îngrijire**

Rețineți instrucțiunile importante de îngrijire de pe site-ul nostru

www.till-hilft.de

Pflegehinweise

**NL****Belangrijke zorginstructies**

Let op de belangrijke zorginstructies op onze website

www.till-hilft.de

Pflegehinweise

**TR****Önemli bakım talimatları**

Lütfen web sitemizdeki önemli bakım talimatlarını dikkate alınız

www.till-hilft.de

Pflegehinweise

**CZ****Důležité pokyny pro péči**

Vezměte prosím na vědomí důležité pokyny pro péči na našich webových stránkách

www.till-hilft.de

Pflegehinweise

**RU****Важные инструкции по уходу**

Обратите внимание на важные инструкции по уходу на нашем веб-сайте

www.till-hilft.de

Pflegehinweise





87256.533

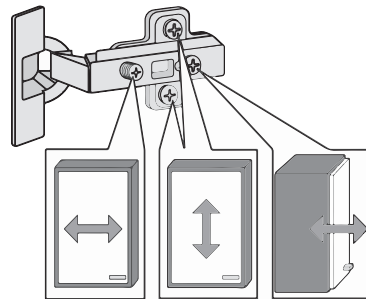
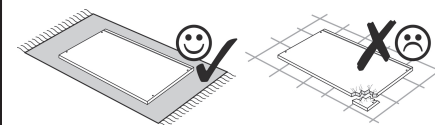
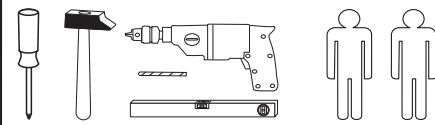
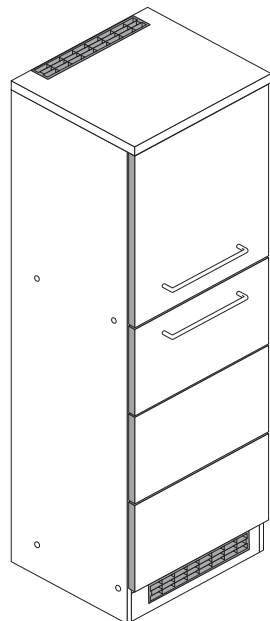

1 8 x 2827	2 8 x	3 4 x 1503	4 4 x 1611	5 8 x 30 28 x 2861	6 3,5 x 15 9 x 2804
7 5mm 2 x 2855	8 2 x	9 4 x	10 5/5 x 16 4 x 2821	11 2 x 2532	12 2 x 2533
13 2 x 4940	14 8mm 4 x	15 8 mm 4 x 2917	16 1 x 2845	17 4,5 x 15 1 x 2805	18 4 x 45 1 x 2814
19 6 x 34 1 x 2844	20 6 x 1119	21 6 x 1125	22 35 mm 2 x 2886	23 4 x 2865	24 25 x 2862
25 4 x 9 5 x 30 2 x 1 x	26 Leim 1 x 2863				

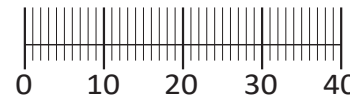

Das beigefügte Wandbefestigungsmaterial (Dübel und Schrauben) eignet sich nur für festes Mauerwerk (z.B.: Beton- oder Ziegelwände). Für andere Wandaufbauten sind eventuell Spezialdübel und andere Schrauben notwendig. Ziehen Sie gegebenenfalls eine Fachkraft zu Rate.

De begeleidende wandmontage hardware (pluggen en schroeven) is alleen geschikt voor massief metselwerk (bijvoorbeeld beton of bakstenen muren). Voor andere muur structuren zijn eventueel bijzondere ankerbouten en andere noodzakelijke. Draai indien nodig, een deskundige.

Приложенный материал для крепления к стене (дюбели и винты) пригоден только для жестких кладок (например, бетонные или кирпичные стены). Для других настенных конструкций необходимы смотря по обстоятельствам специальные дюбели и другие винты. При необходимости проконсультируйтесь у специалиста.

Le mur d'accompagnement matériel de montage (chevilles et les vis) ne convient que pour la maçonnerie solide (par exemple en béton ou des murs de briques). Pour les structures de mur d'autres sont peut-être spéciale boulons d'ancrage et d'autres nécessaires. Serrer le cas échéant, un expert.

Załączony materiał do mocowania do ściany (kolki rozprężne i wkręty) nadaje się tylko do ścian murowanych (np. z betonu lub cegiel). Do ścian wykonanych w innych technologiach konieczne być mogą specjalne kolki rozprężne i inne wkręty. W razie potrzeby skorzystaj z fachowej pomocy

Il muro di accompagnamento hardware di montaggio (tasselli e viti) è adatto solo per muratura piena (ad esempio calcestruzzo o muratura). Per le altre strutture murarie sono forse speciali bulloni di ancoraggio e necessari di altri. Serrare se necessario, un esperto.

The accompanying wall mounting hardware (anchors and screws) is suitable only for solid masonry (eg concrete or brick walls). For other wall structures are possibly special anchor bolts and other necessary. Tighten if necessary, an expert.

Ekteki duvara sabit montaj malzemeleri (dübel ve vidalar), sadece sağlam duvarlar için (örnek: beton veya tuğla) elverişlidir. Başka duvarlar için özel dübeller ve farklı vidalar gerekebilir. Gerekliğinde bir uzmana danışınız.

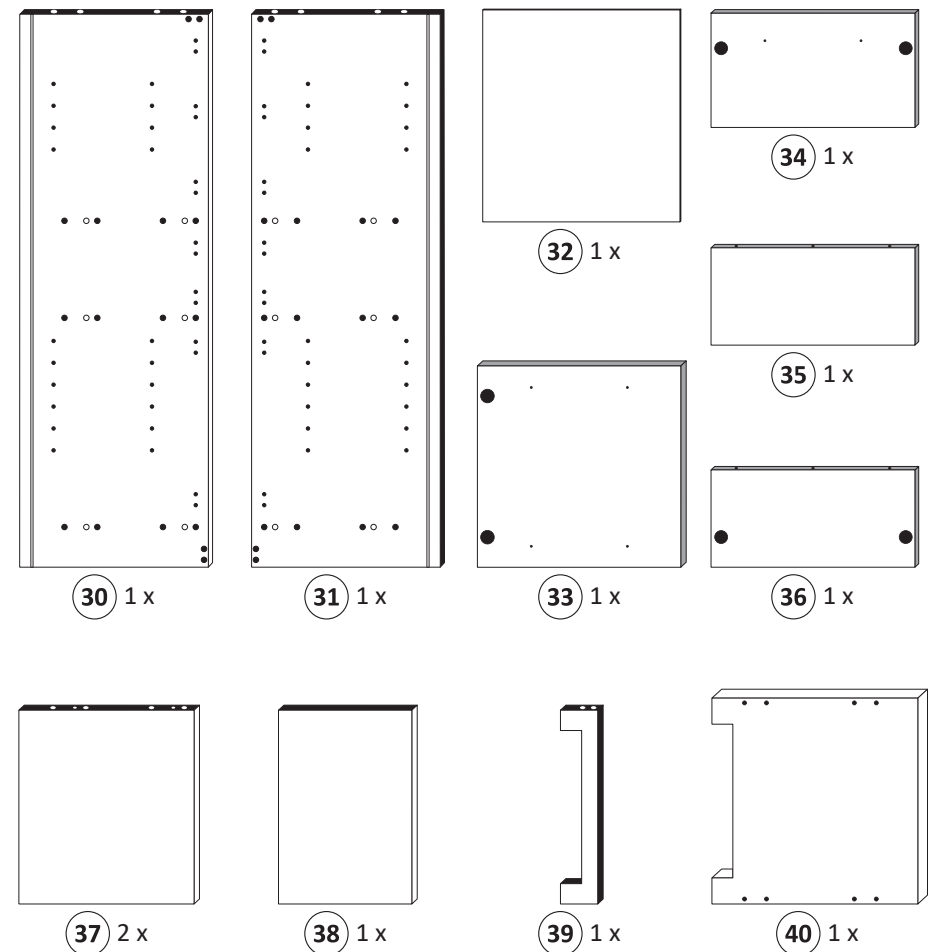

1

4 4 x 1611	5 8 x 30 8 x 2861	10 5/5 x 16 4 x 2821	15 8 mm 4 x 2917	26 Leim 1 x 2863
---------------	-------------------------	----------------------------	------------------------	------------------------

Bitte beachten !
In dieser Aufbauanleitung ist die Tür rechts angeschlagen. Soll die Tür links angeschlagen werden, müssen die Kreuzmontageplatten auf das linke Seitenteil montiert werden.

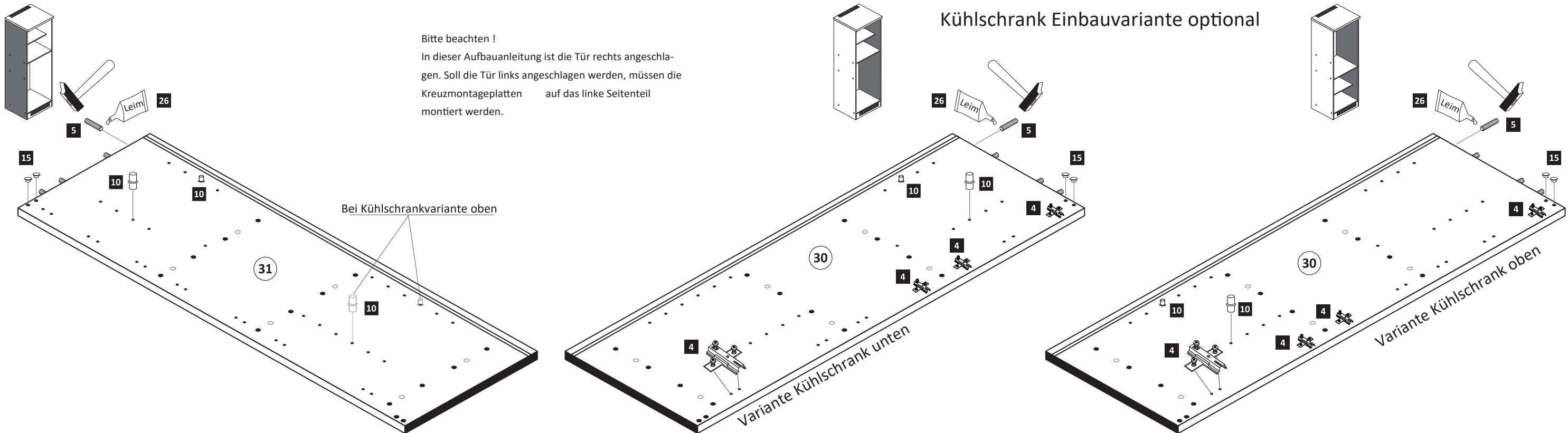

2

5	8 x 30 20 x 2861	11	2 x 2532	13	1 x 4940	26	1 x 2863
---	---------------------	----	----------	----	----------	----	----------

37 2 x

39

Leim

4

24	25 x 2862
----	-----------

Variante Kühlschrank unten

Variante Kühlschrank oben

3

1	8 x 2827	2	8 x	12	2 x 2533	13	1 x 4940
---	----------	---	-----	----	----------	----	----------

26	1 x 2863
----	----------

D Leim
GB Glue
NL Lijm
PL Klej
TR Tutkal
F Colle
I Colla

20 min.

31

37

39

Leim

Variante Kühlschrank unten

Variante Kühlschrank oben

5

14	8mm 4 x
----	------------

21

38

Variante Kühlschrank unten

Variante Kühlschrank oben

6

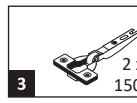
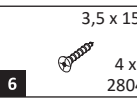
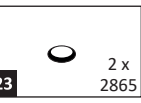
-  2 x 1503
-  3,5 x 15 4 x 2804
-  2 x 2865

ACHTUNG !
Montagebeispiel Rechtsanschlag
Bei Linksanschlag andere
Griffbohrungen durch bohren !

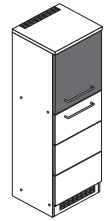

Variante Kühlschrank unten

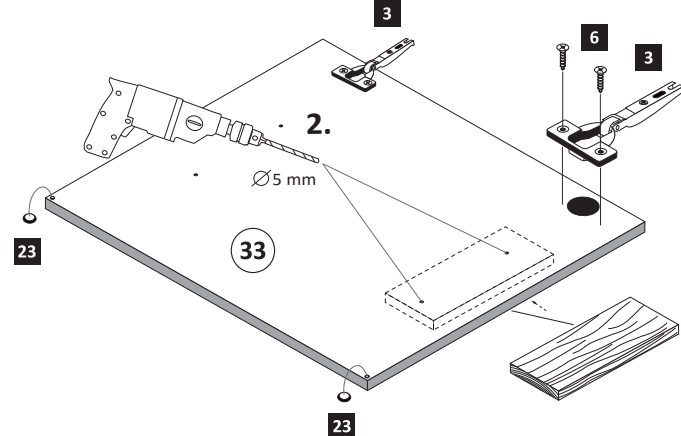
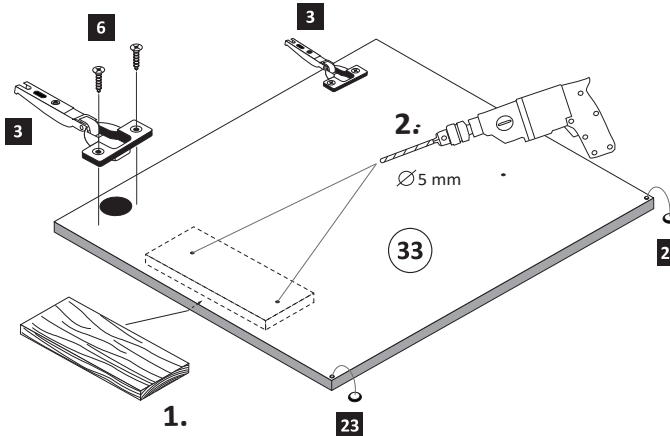

Variante Kühlschrank oben

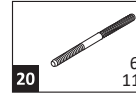
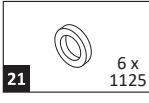

7

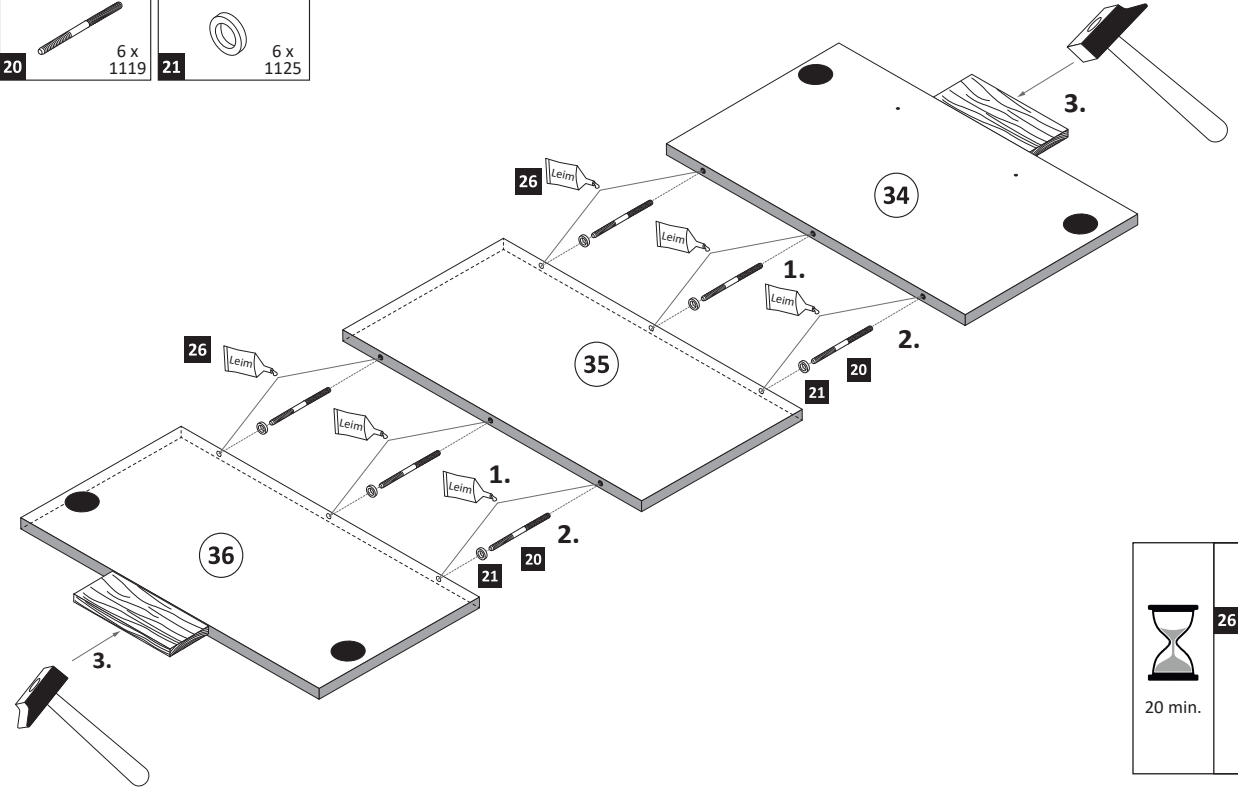
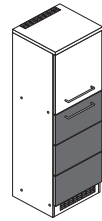
-  6 x 1119
-  6 x 1125



	20 min.
	1 x 2863
D Leim GB Glue NL Lijm PL Klej TR Tutkal F Colle I Colla	

8

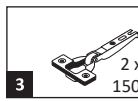
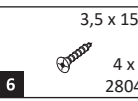
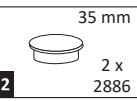
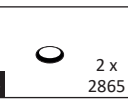
-  2 x 1503
-  3,5 x 15 4 x 2804
-  35 mm 2 x 2886
-  2 x 2865

ACHTUNG !
Montagebeispiel
Rechtsanschlag!
Bei Linksanschlag
andere Scharnierbohrung verwenden !

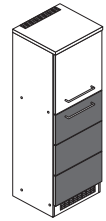

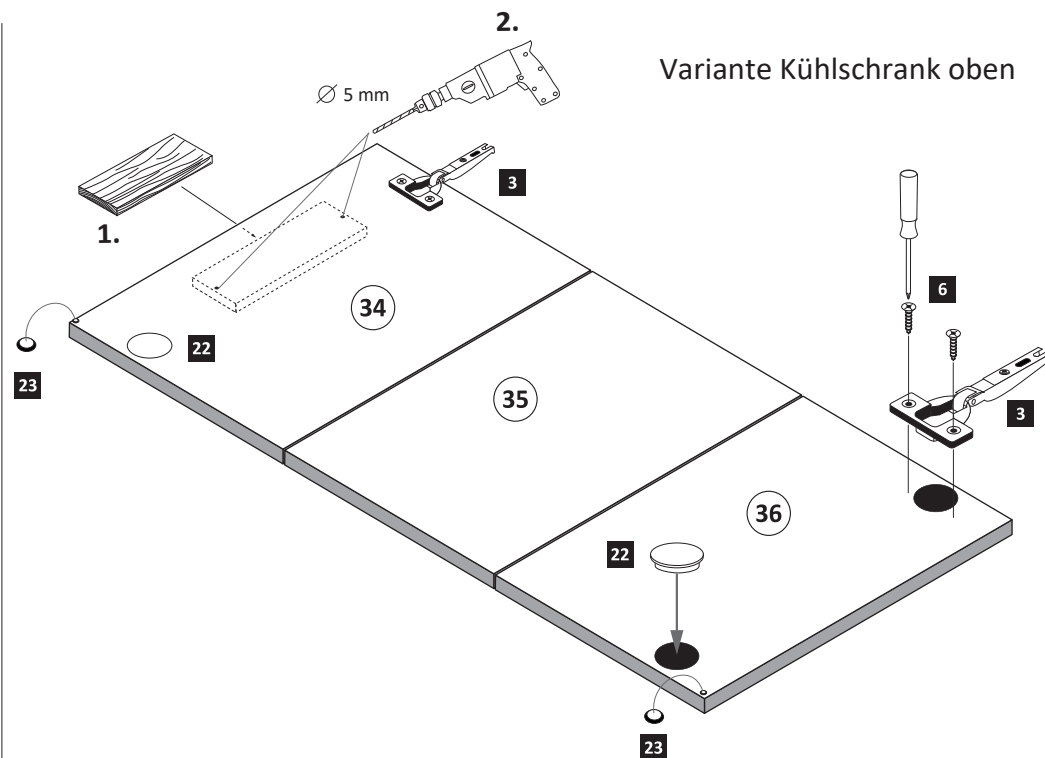
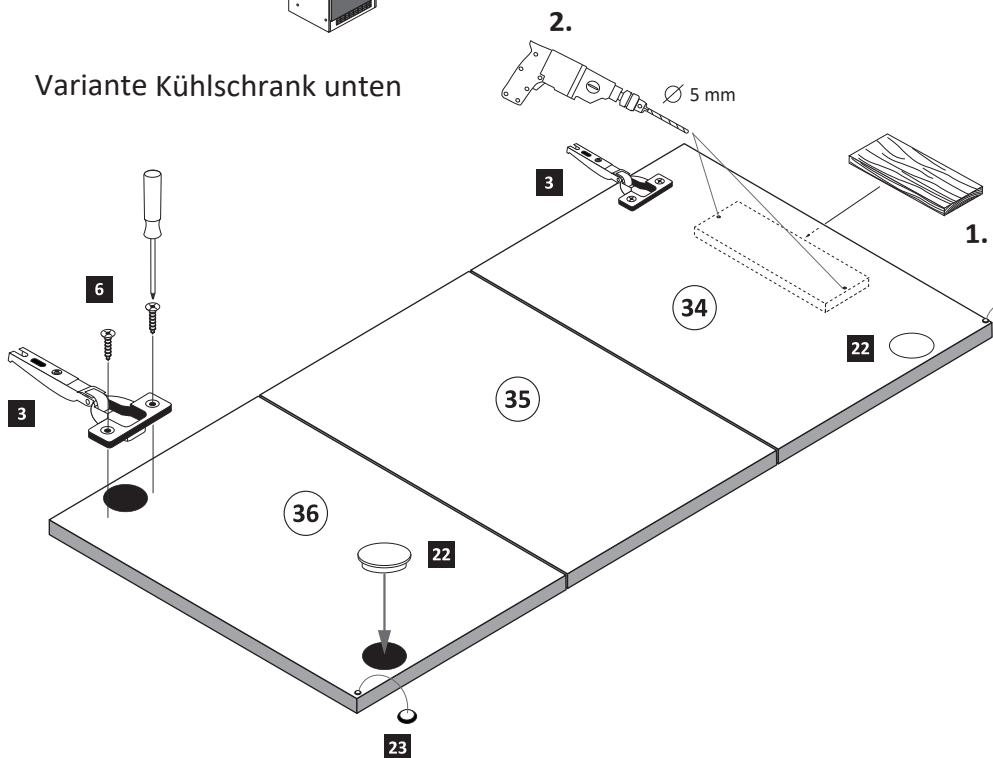

Variante Kühlschrank unten

Variante Kühlschrank oben



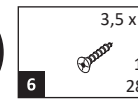

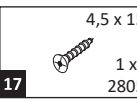
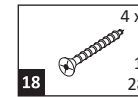
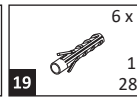
9

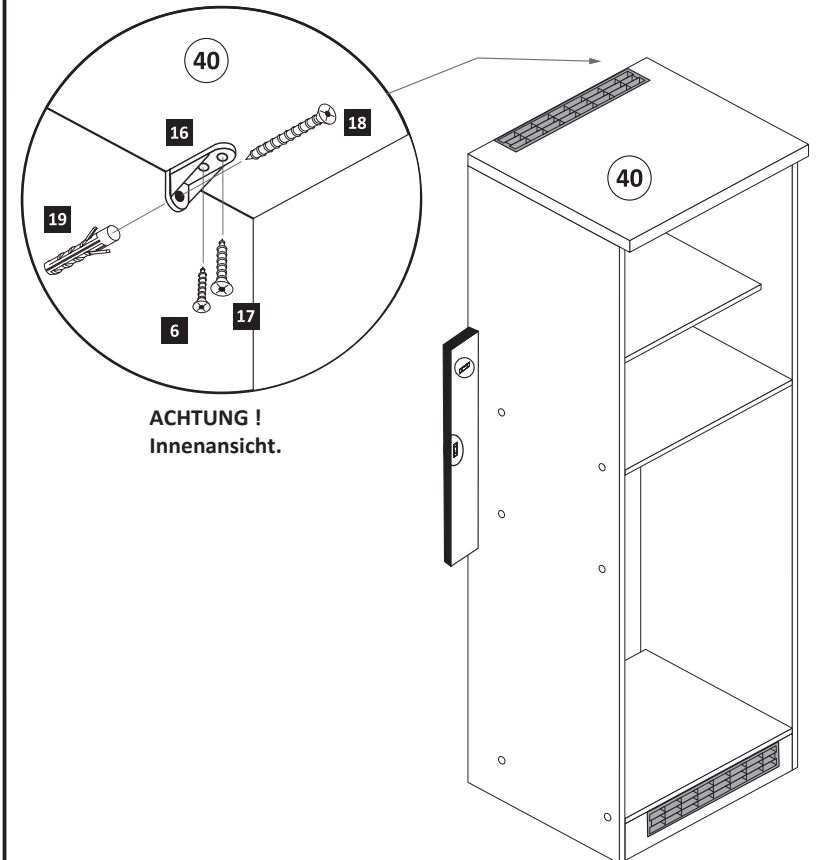
-  3,5 x 15 1 x 2804
-  1 x 2845
-  4,5 x 15 1 x 2805
-  4 x 45 1 x 2814
-  6 x 34 1 x 2844



10

- | | | |
|---|---|-----|
| 5mm |  | 2 x |
|  | 2855 | 2 x |
|  | 4 x | |

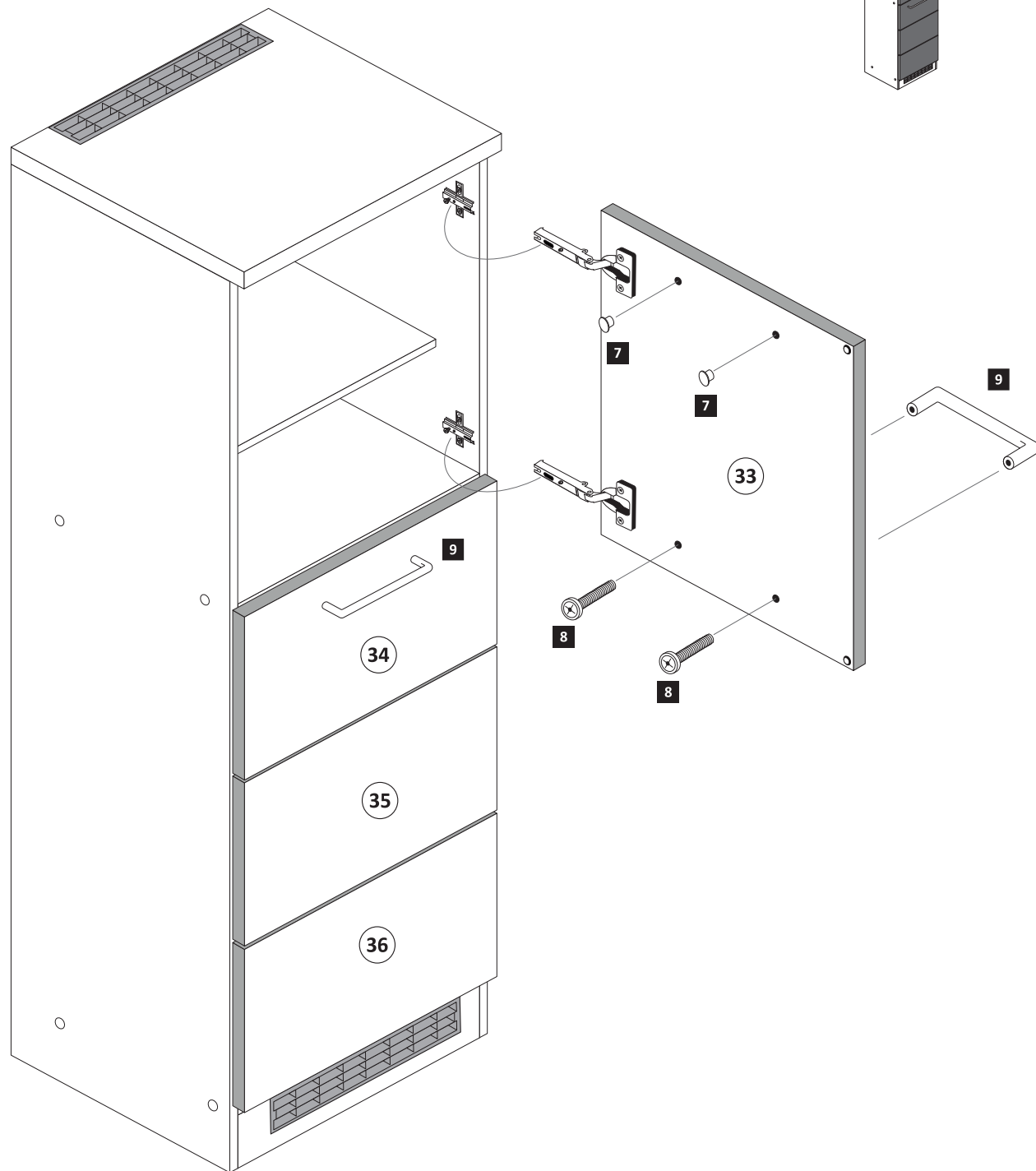

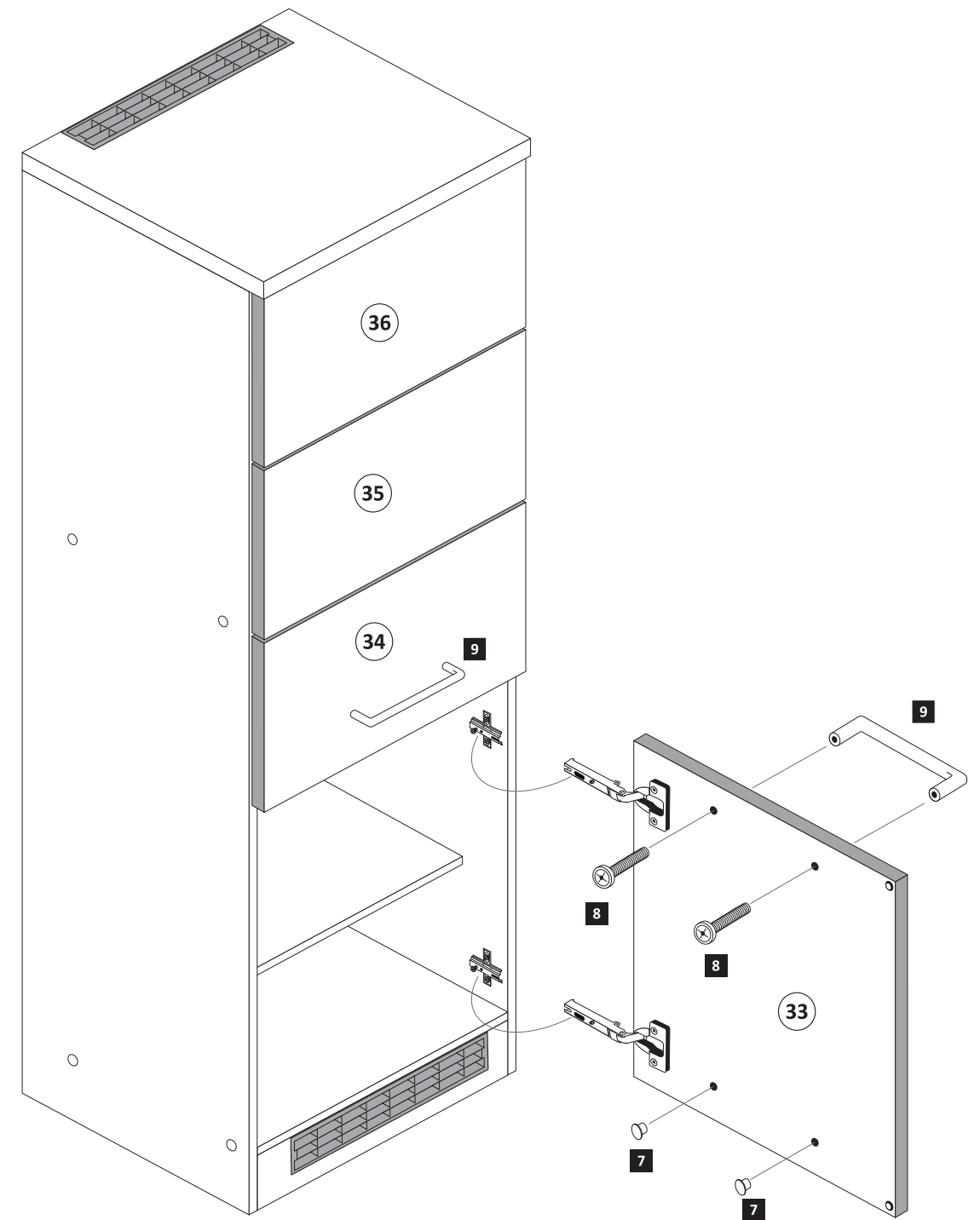

Variante Kühlschrank unten



Variante Kühlschrank oben

11

- | | |
|---|---|
| 4 x 9 | 5 x 30 |
|  |  |
| 25 | 2 x |
| | 1 x |

