



John Vintage



- (DE) Montageanleitung
- (PL) Instrukcja montażu
- (NL) Handleiding voor de montage
- (GB) Assembly instructions
- (TR) Montaj talimatı
- (RU) Инструкция по монтажу

- (IT) Istruzioni di montaggio
- (FR) Notice de montage
- (RO) Instrucțiuni de asamblare
- (SK) Montážny návod
- (CZ) Montážní návod
- (HU) Szerelési útmutató

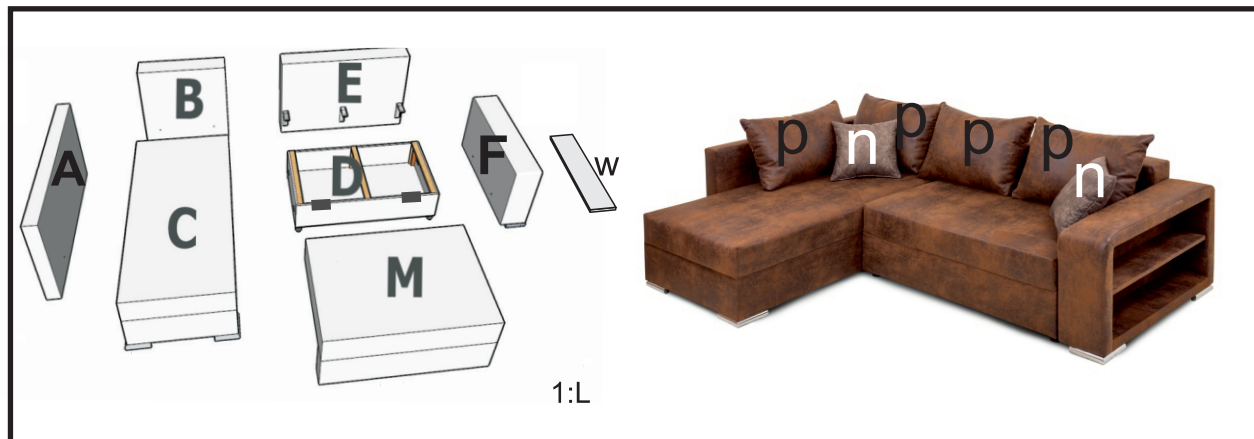

4x (M8x60)	4x (M8x90)	8x	8x	Ø8	8x	M8	9x (4x16)	8x (5x35)
	8x (M6x35)	1x	8x	40mm	4x	2x	4x	
				50mm				

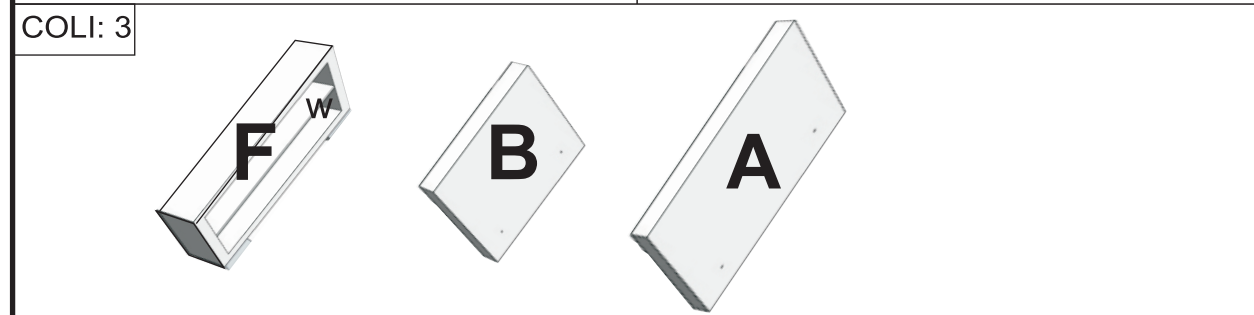
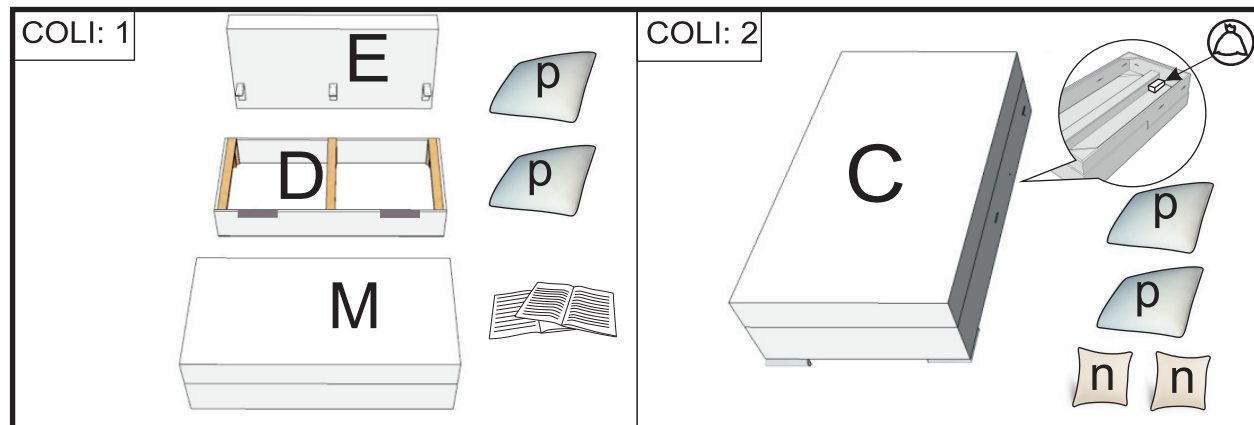

Ver: |05.01.2021

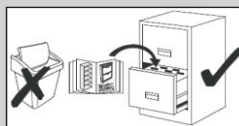
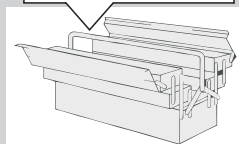
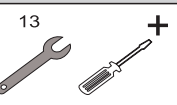
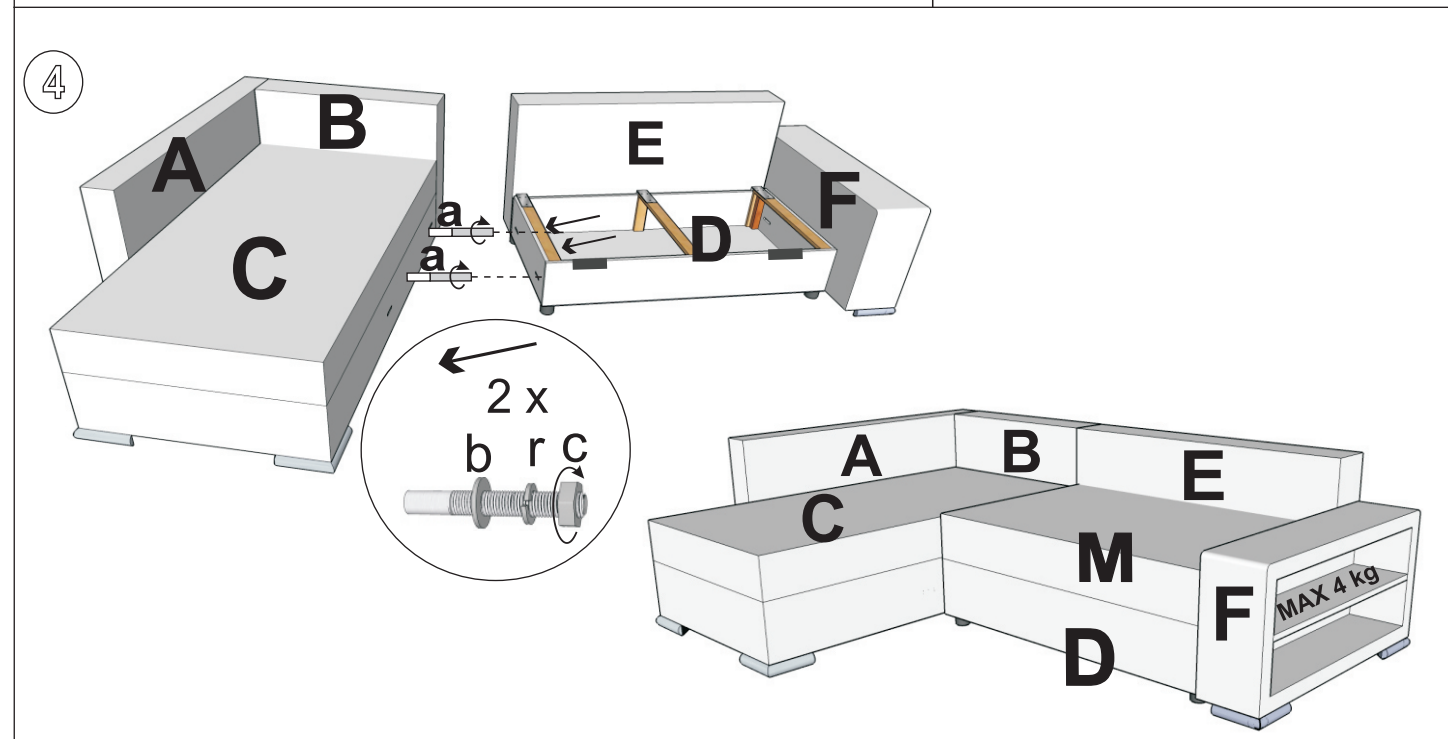
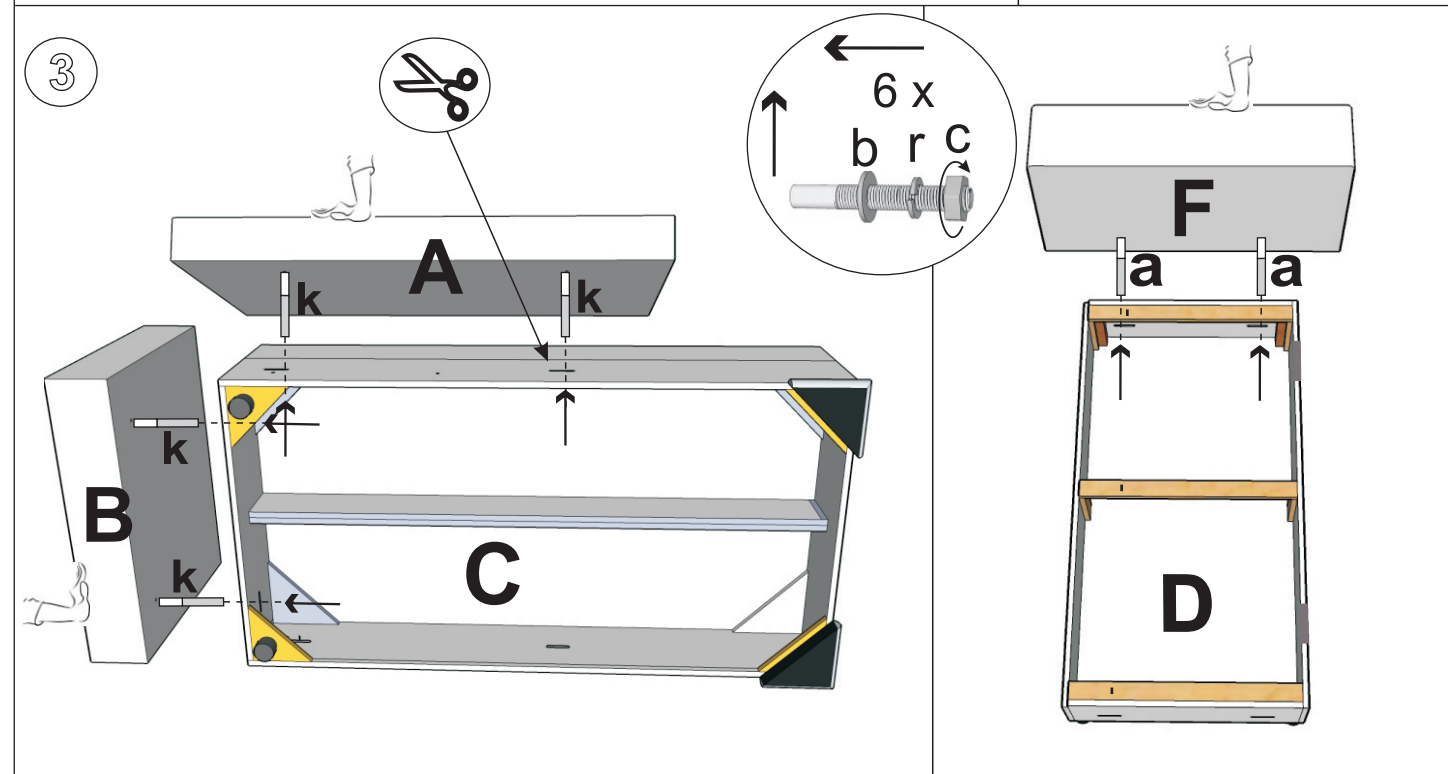
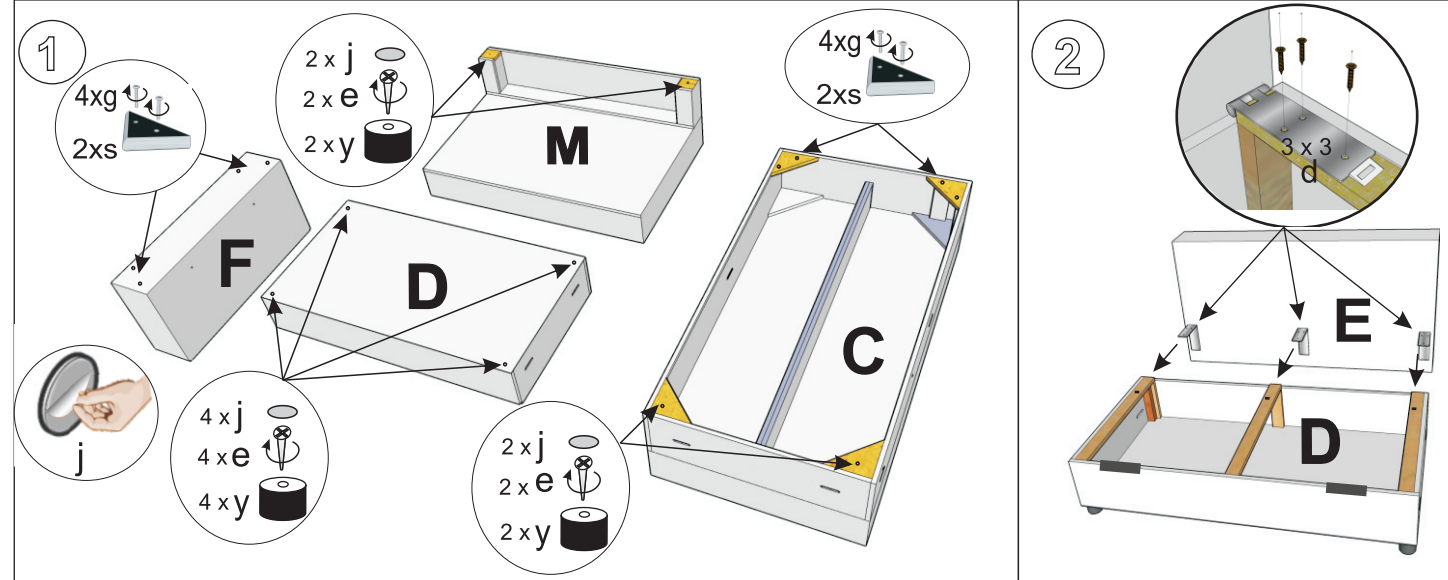



John Vintage



- (DE) Montageanleitung
- (PL) Instrukcja montażu
- (NL) Handleiding voor de montage
- (GB) Assembly instructions
- (TR) Montaj talimatı
- (RU) Инструкция по монтажу

- (IT) Istruzioni di montaggio
- (FR) Notice de montage
- (RO) Instrucțiuni de asamblare
- (SK) Montážny návod
- (CZ) Montážní návod
- (HU) Szerelési útmutató

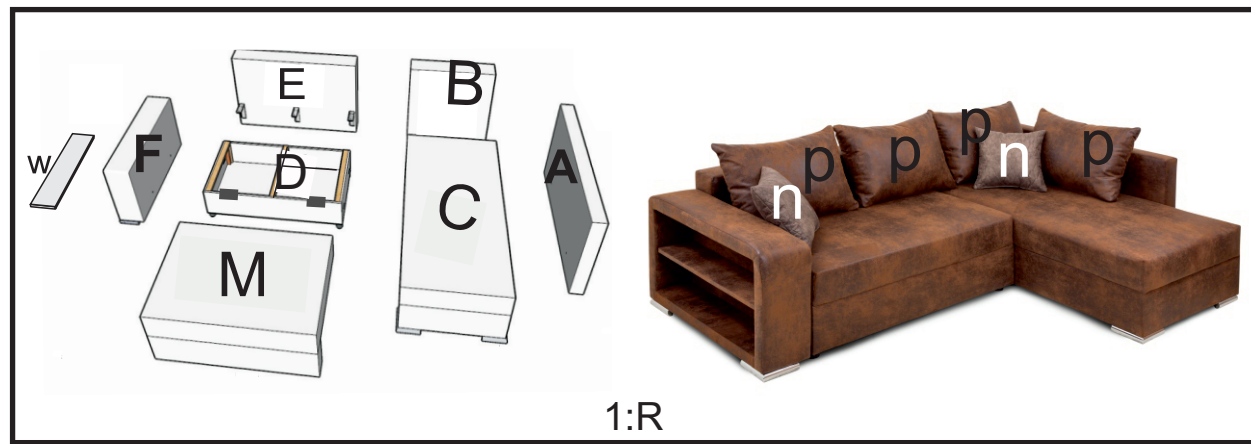

4x (M8x60)	4x (M8x90)	8x	8x Ø8	8x	8x M8	9x (4x16)	8x (5x35)
	8x (M6x35)	1x	8x 40mm	4x	2x	4x	

