

- (D) Montageanleitung
- (GB) Assembly instructions
- (NL) Handleiding voor de montage

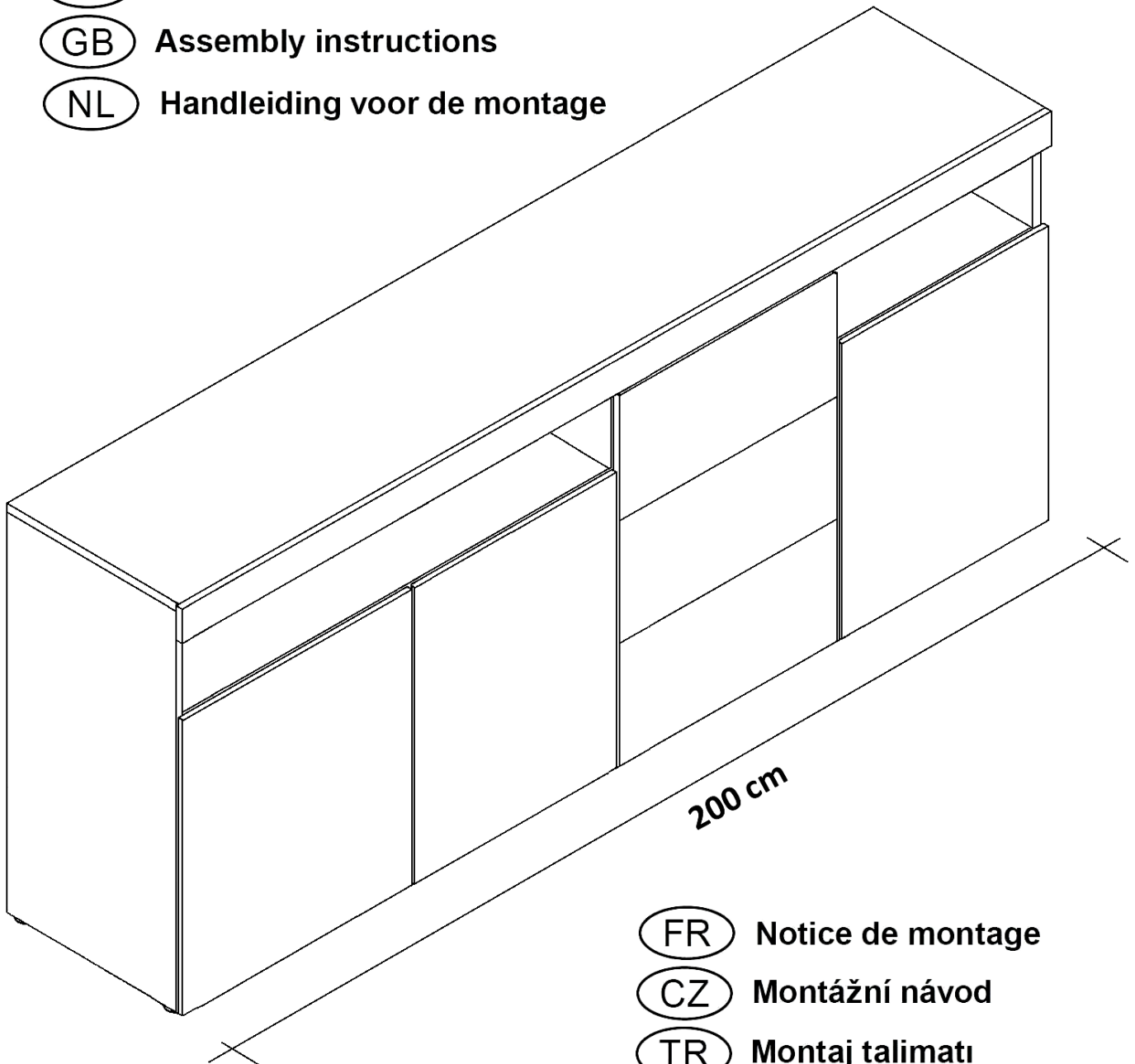

- (HU) Szerelési útmutató
- (PL) Instrukcja montażu
- (RO) Instrucțiuni de montaj

- (FR) Notice de montage
- (CZ) Montážní návod
- (TR) Montaj talimatı
- (IT) Istruzioni di montaggio
- (SK) Návod na montáž
- (RU) Инструкция по монтажу

**Service • Assistenza • Dienstverlening • Serwis
Servis • Szerviz • Сервисная служба**

Name • Nom • Nome • Naam •
Nazwa • Jméno • Názov • Név •
Denimire • İsim • Название

Nr. • No. • N° • Номер • Č • Sz

Typ • Type • Tipe • Típus • Tipo •
Тип

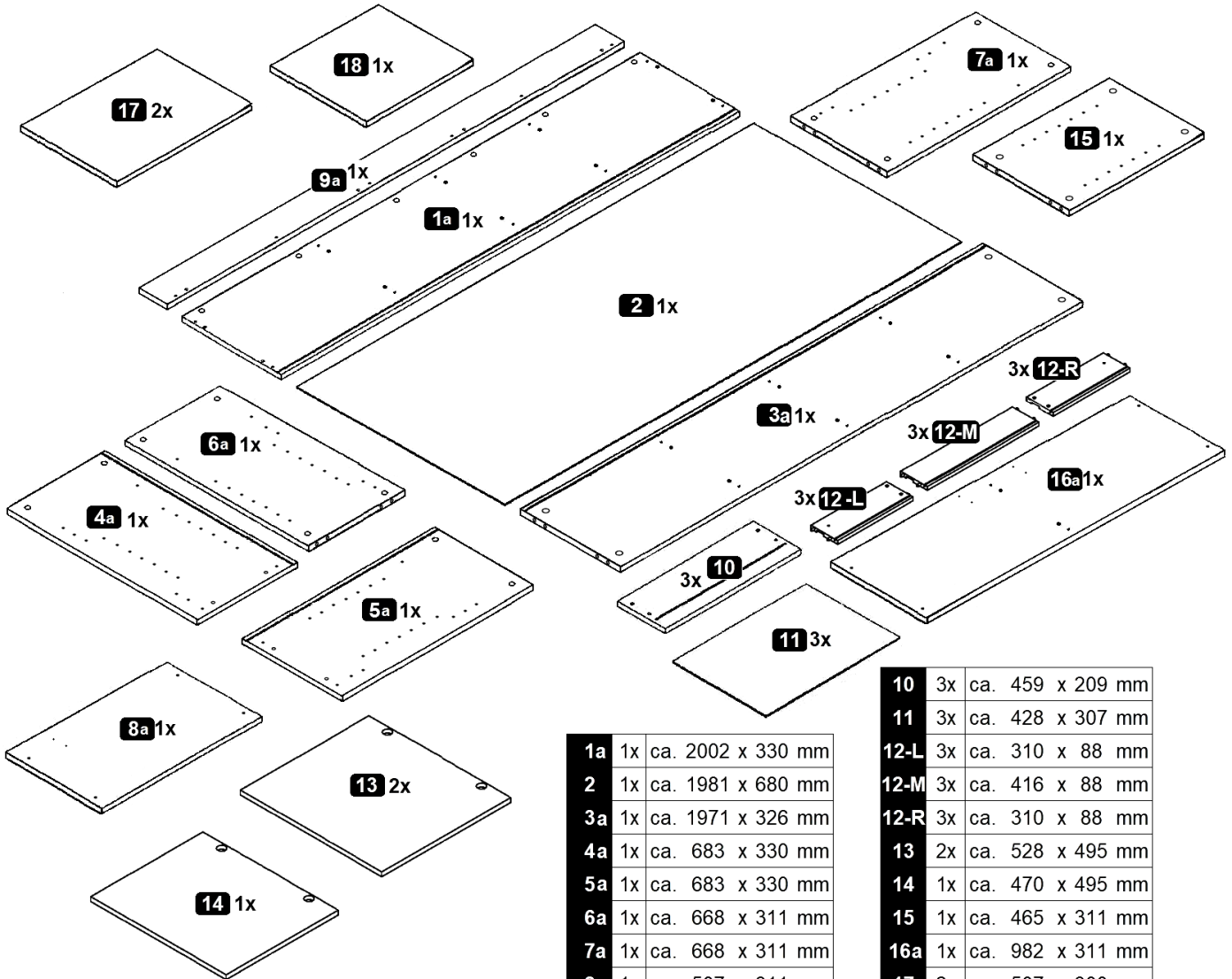
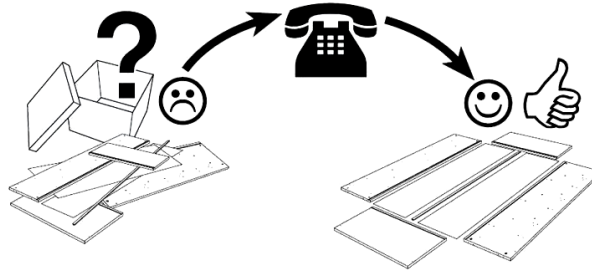
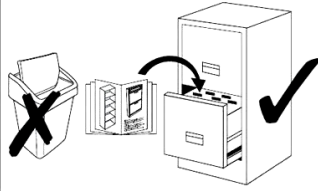

1a	1x	ca. 2002 x 330 mm
2	1x	ca. 1981 x 680 mm
3a	1x	ca. 1971 x 326 mm
4a	1x	ca. 683 x 330 mm
5a	1x	ca. 683 x 330 mm
6a	1x	ca. 668 x 311 mm
7a	1x	ca. 668 x 311 mm
8a	1x	ca. 507 x 311 mm
9a	1x	ca. 2002 x 60 mm

10	3x	ca. 459 x 209 mm
11	3x	ca. 428 x 307 mm
12-L	3x	ca. 310 x 88 mm
12-M	3x	ca. 416 x 88 mm
12-R	3x	ca. 310 x 88 mm
13	2x	ca. 528 x 495 mm
14	1x	ca. 470 x 495 mm
15	1x	ca. 465 x 311 mm
16a	1x	ca. 982 x 311 mm
17	2x	ca. 507 x 300 mm
18	1x	ca. 459 x 300 mm

A 8,0 x 30 mm 24x	B 26x	C 26x	D 3,9x9,5mm 6x	E h=2 6x	F Ø35 Kr.0 3,5x13mm 4x	G Ø35 Kr.8 1x
H 4,0 x 20 mm 7x	I 7x	J 2,7 x 20 mm 12x	K 6,3 x 13 mm 12x	L 17 x 310 mm 6x	M M4,0 x 9 mm 6x	N 3,5x13mm 2x
O 12x	P 8x					



1

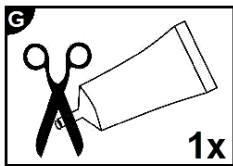
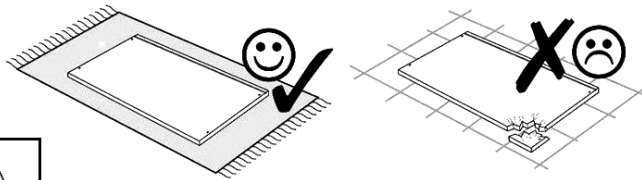

- D Leim
- GB Glue
- FR Colle
- IT Colla
- NL Lijm
- PL Klej
- CZ Lepidlo
- SK Glej
- HU Enyv
- RO Adeziv
- TR Tutkal
- RU Клей

3x

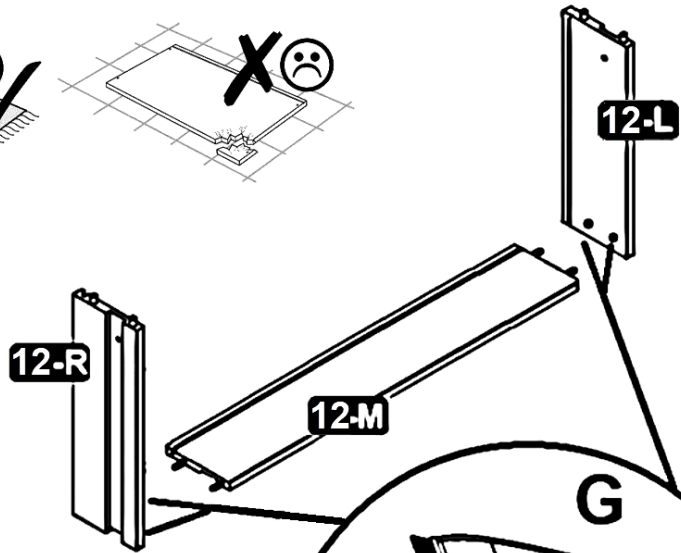

3x

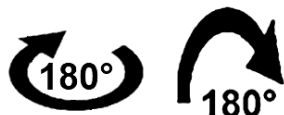
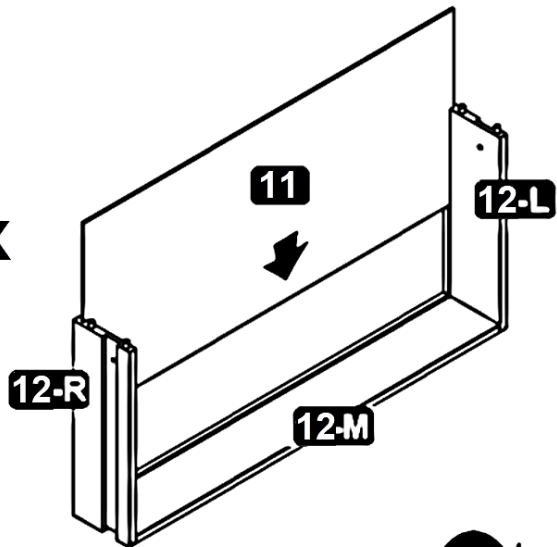

3x

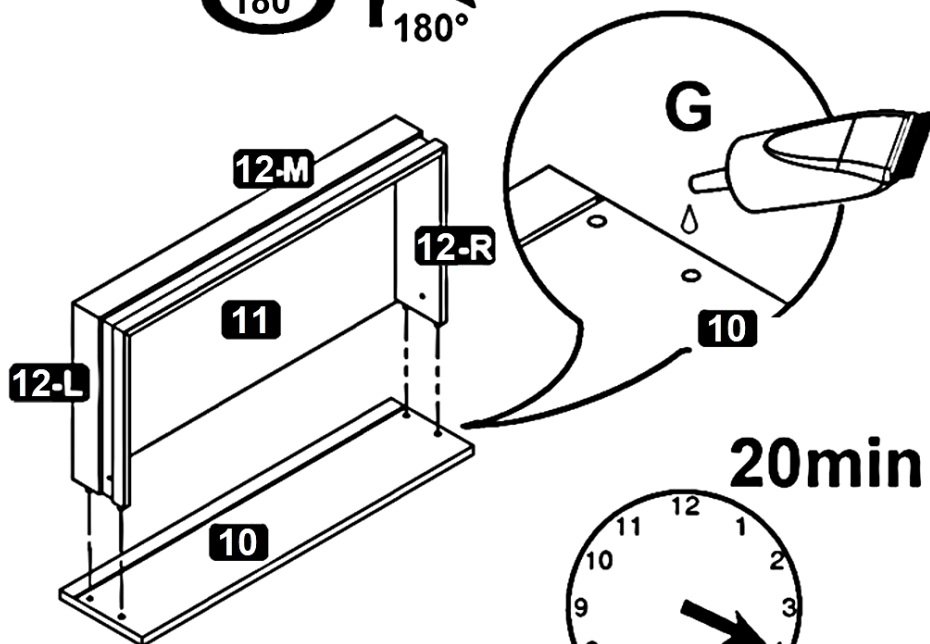

MA5

2

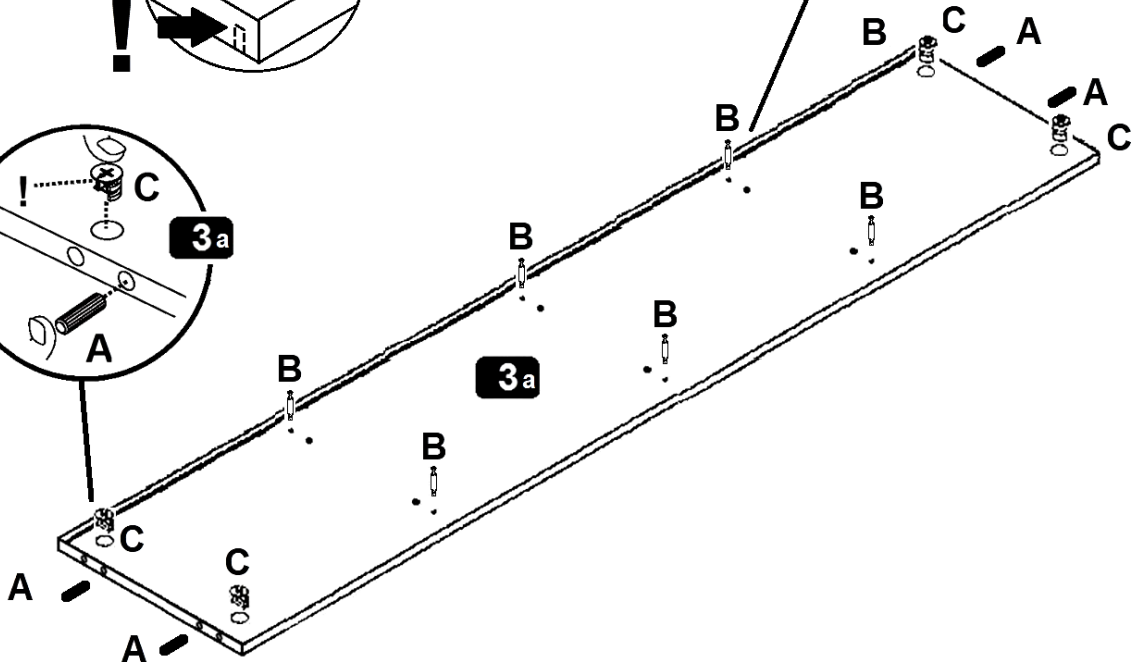
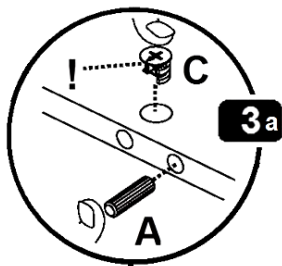
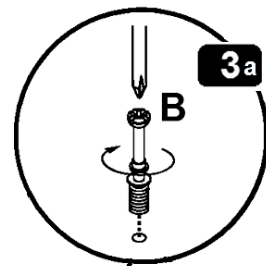
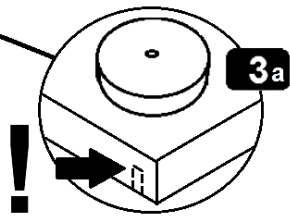
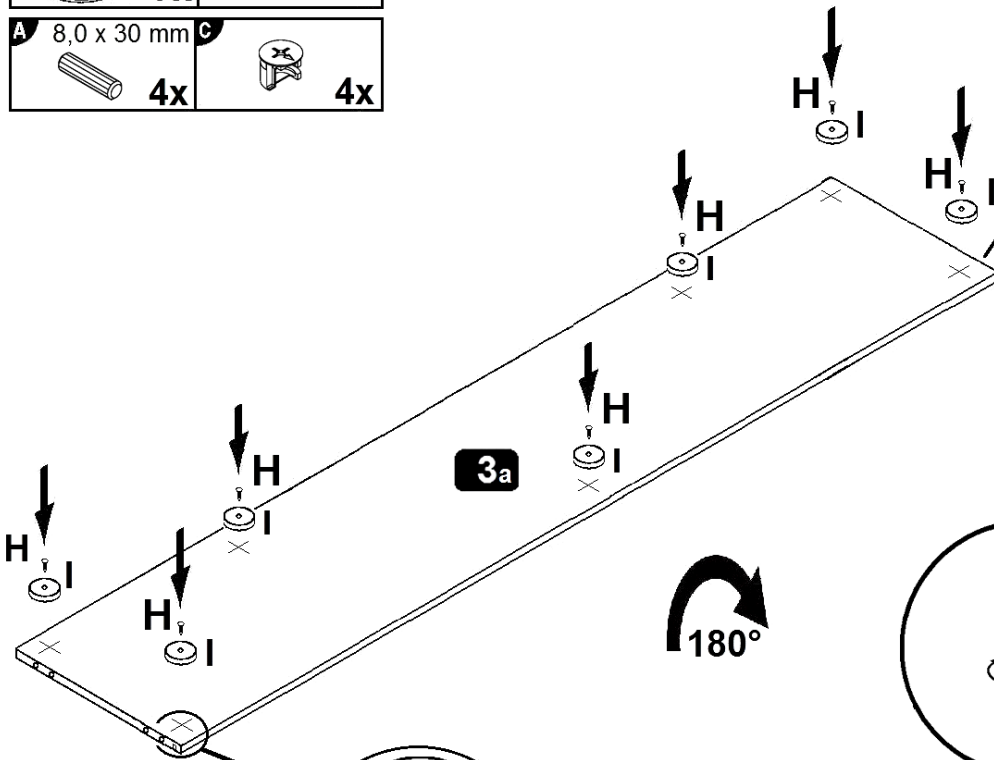
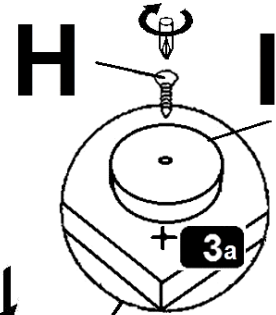
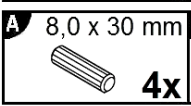
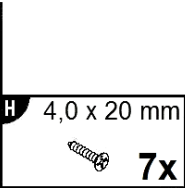
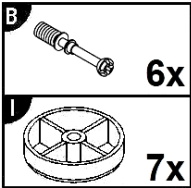
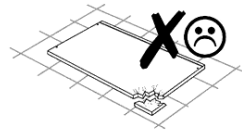
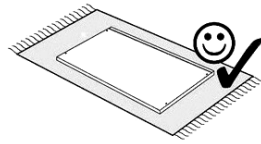
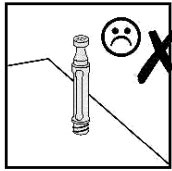
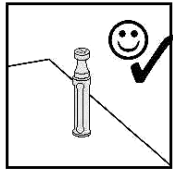



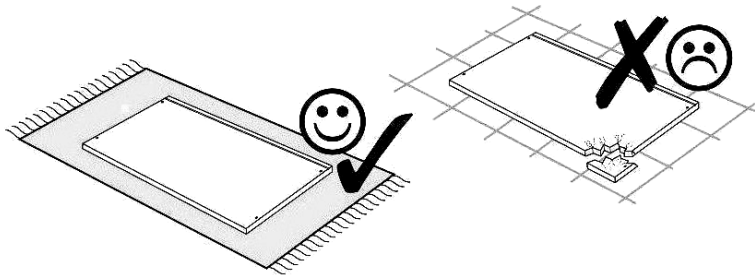
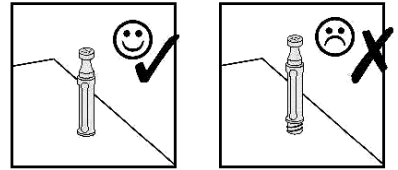
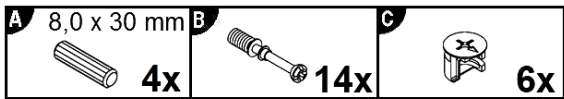

3

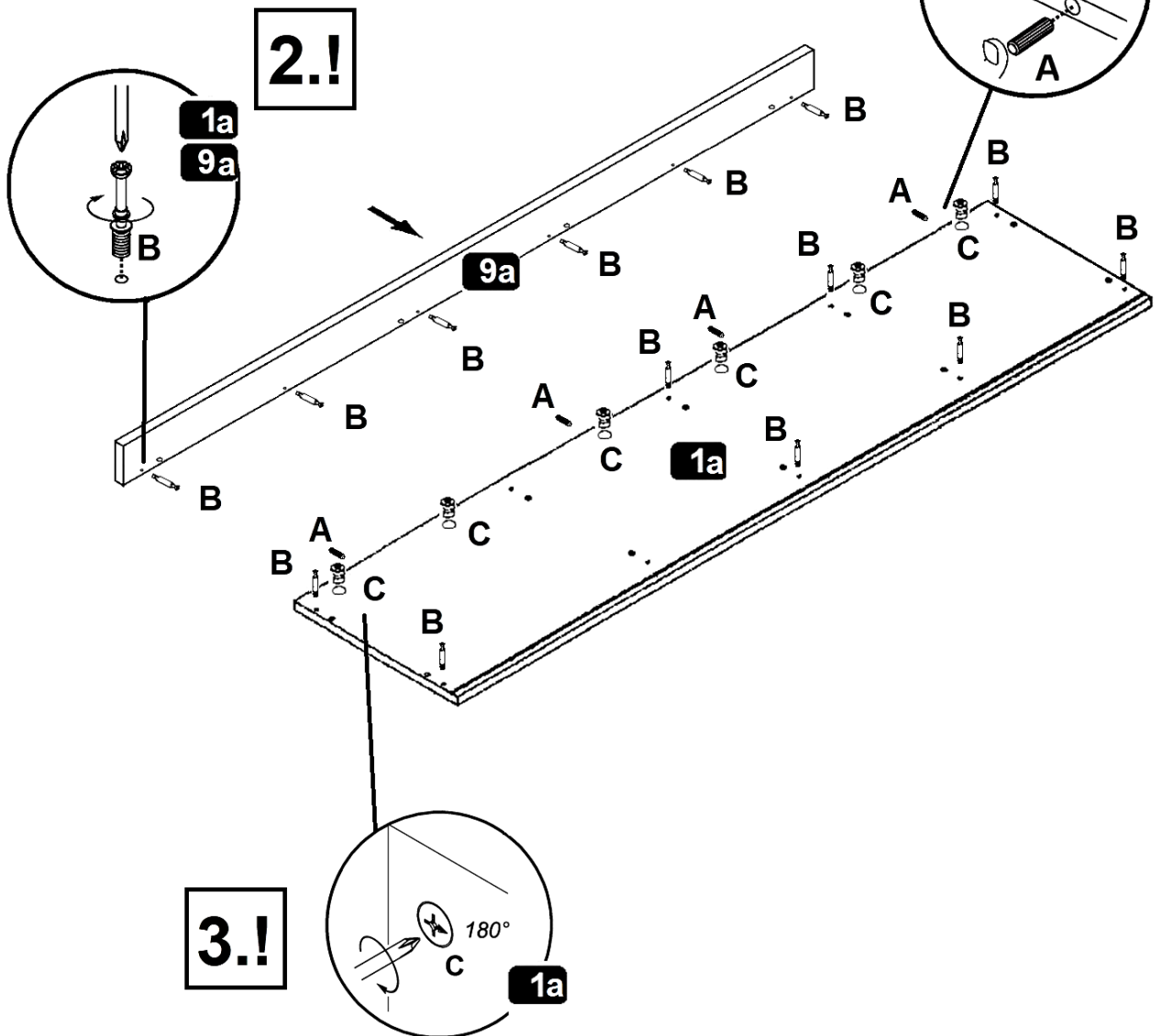

1.!







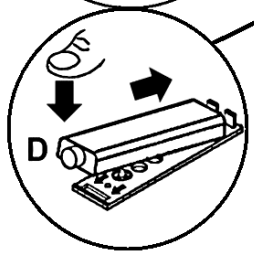
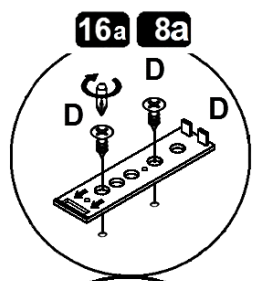
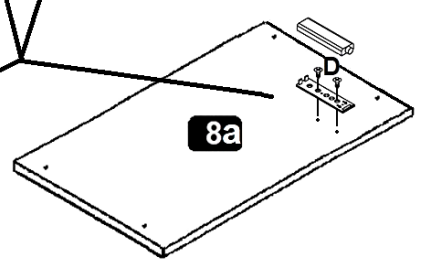
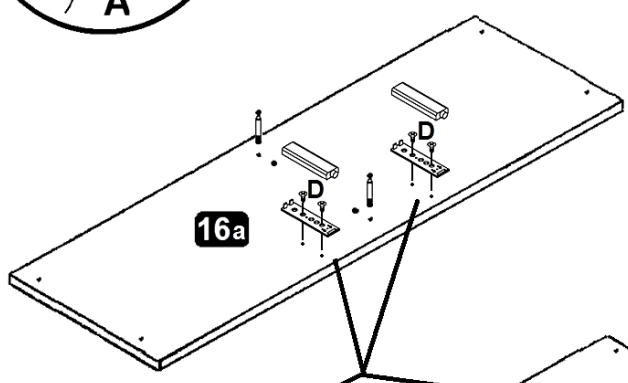
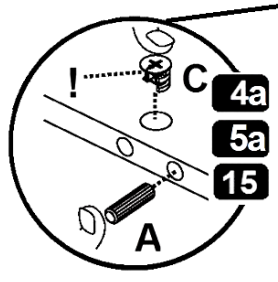
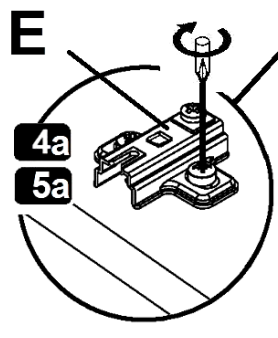
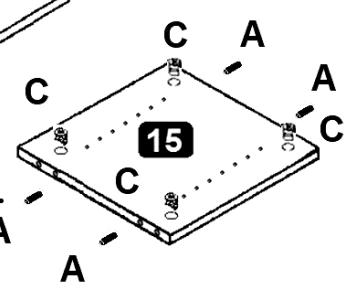
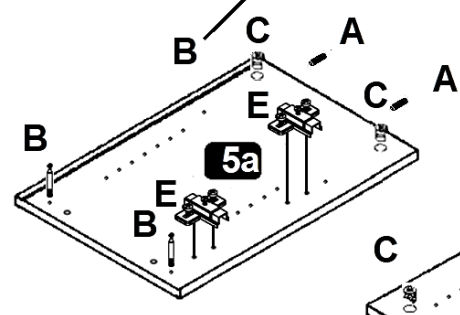
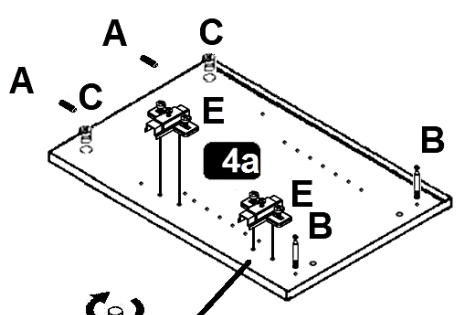
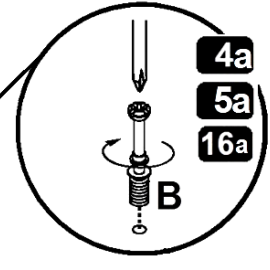
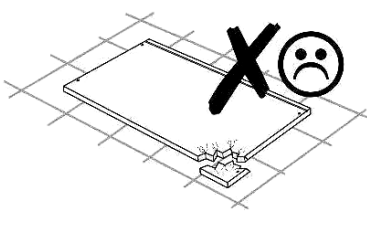
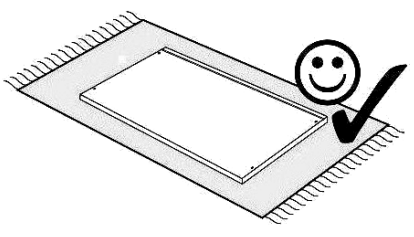
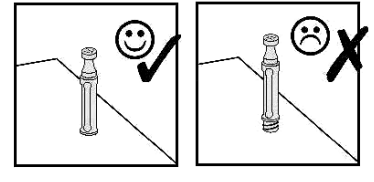

4

A 8,0 x 30 mm  8x	B  6x	C  8x	D 3,9x9,5mm  3x E h=2  4x
---	---	---	--

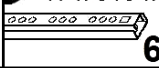

5

A 8,0 x 30 mm  8x	C  8x	E  h=2 2x	K 6,3 x 13 mm  12x	L 17 x 310 mm  6x
				D  3,9x9,5mm  3x

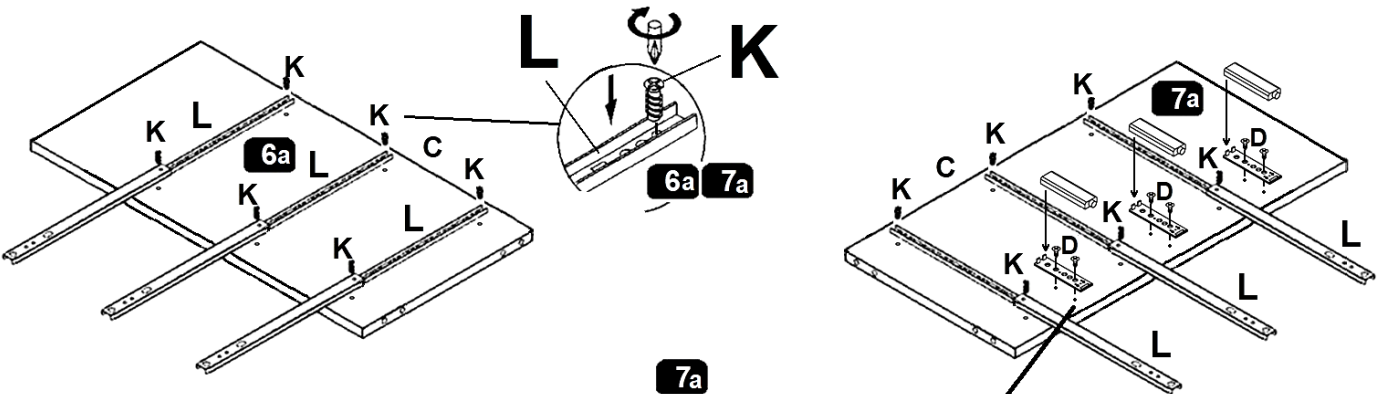
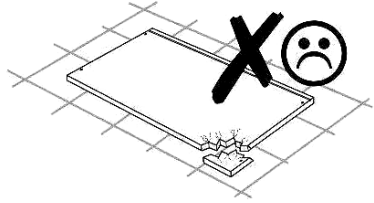
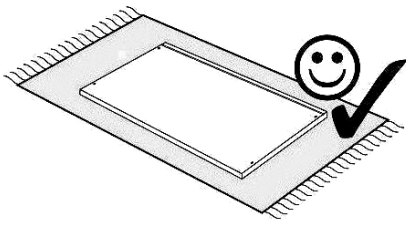

180°

180°

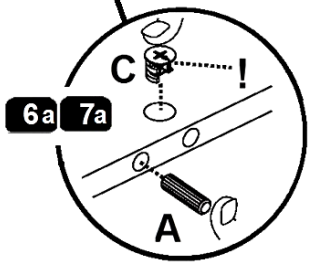
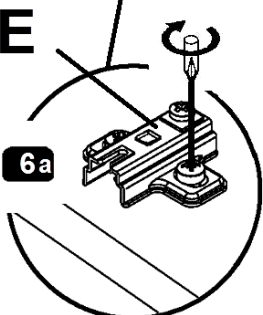
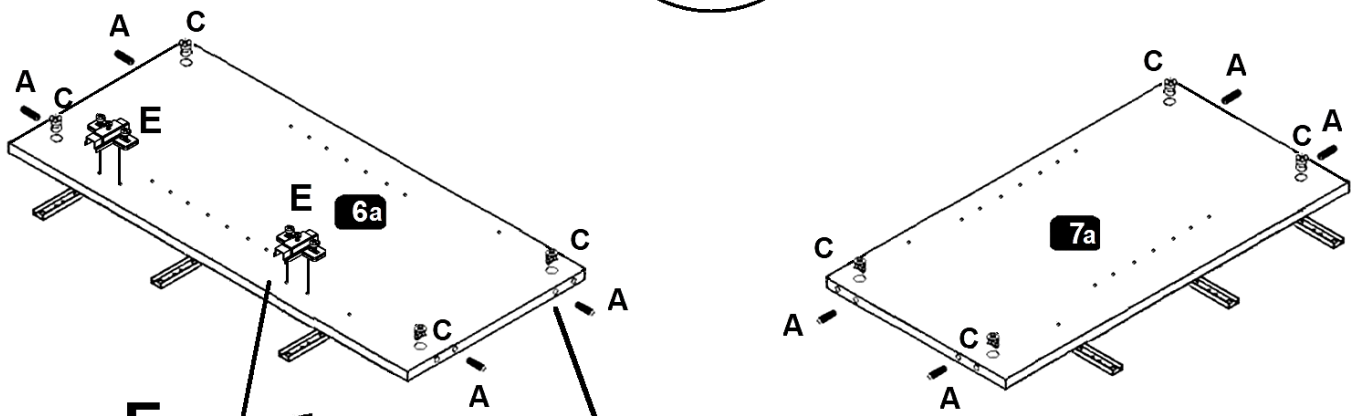
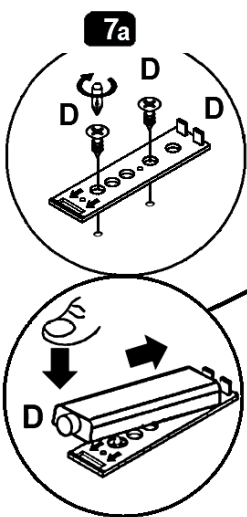

MA5

6

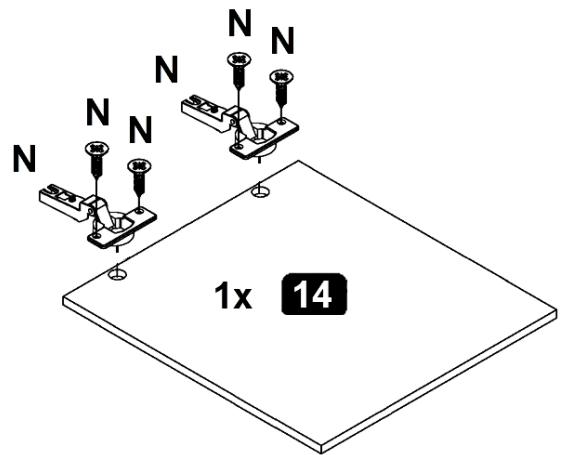
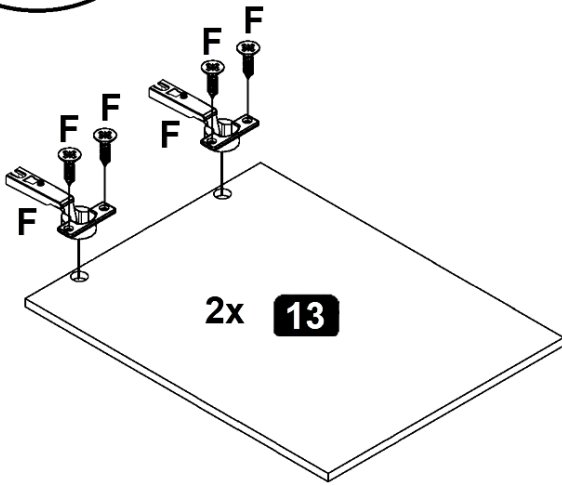
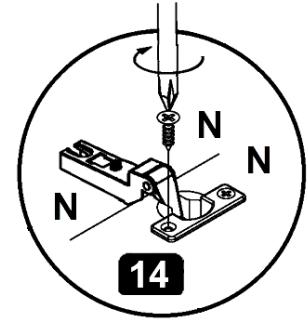
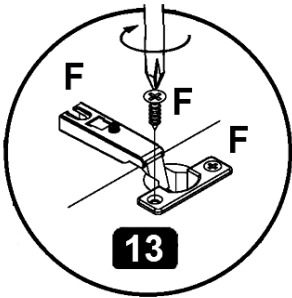
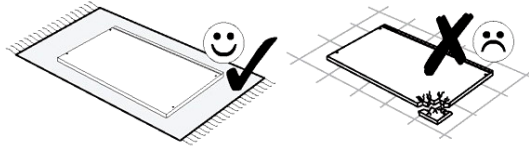
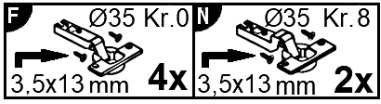

7

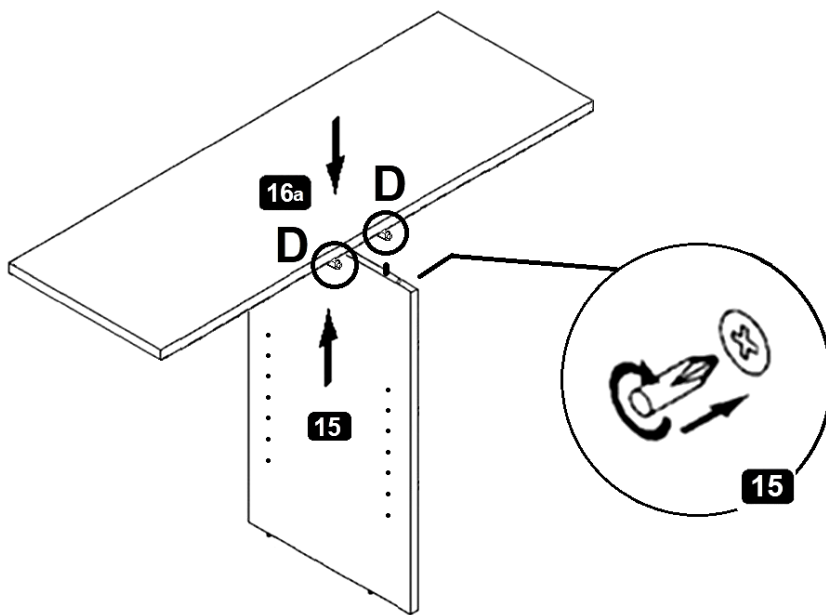

8

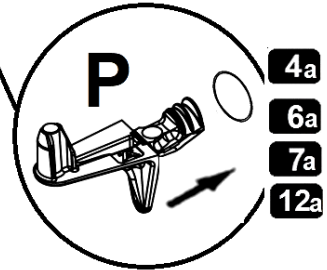
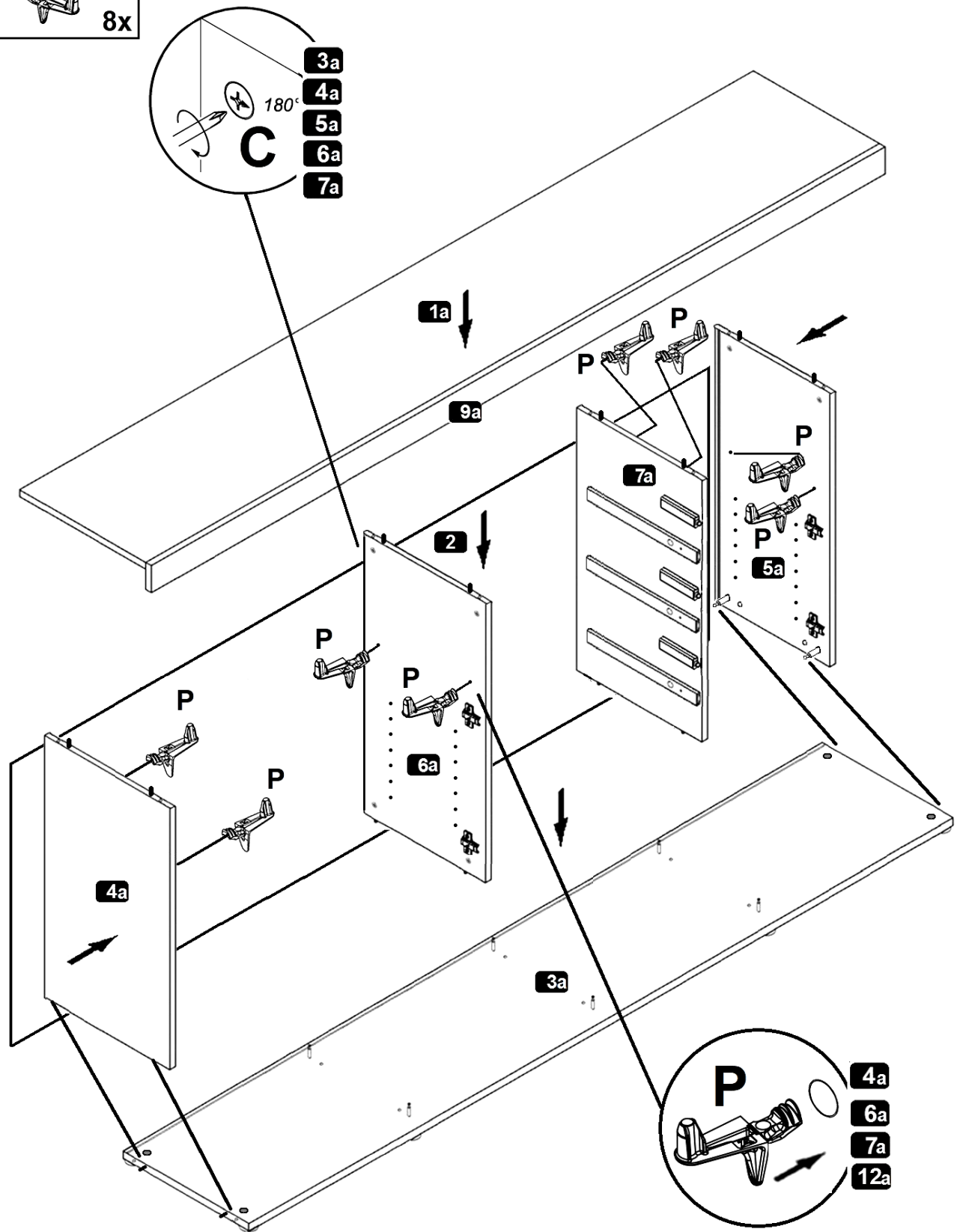
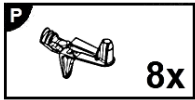

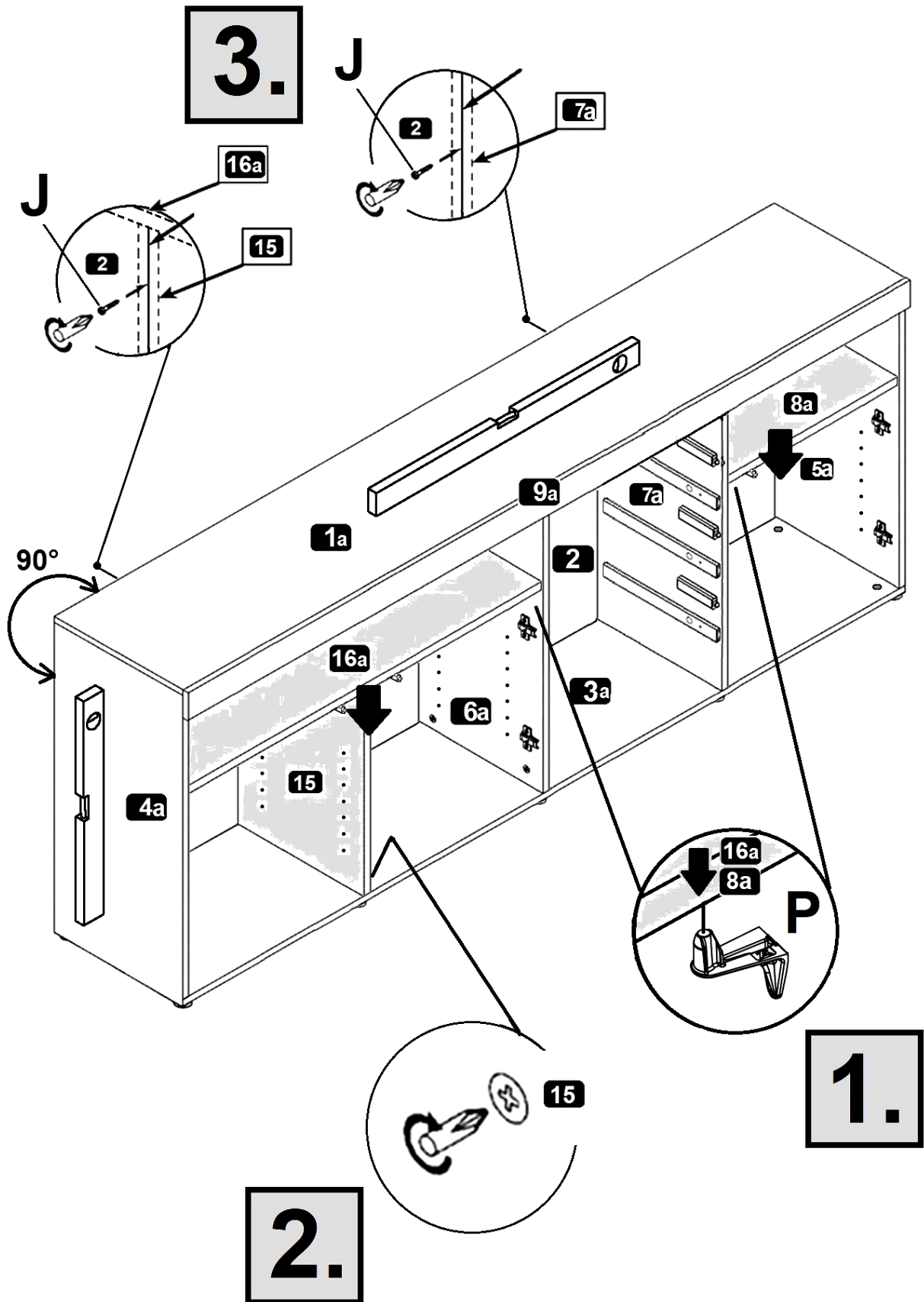

9

J 2,7 x 20 mm
12x

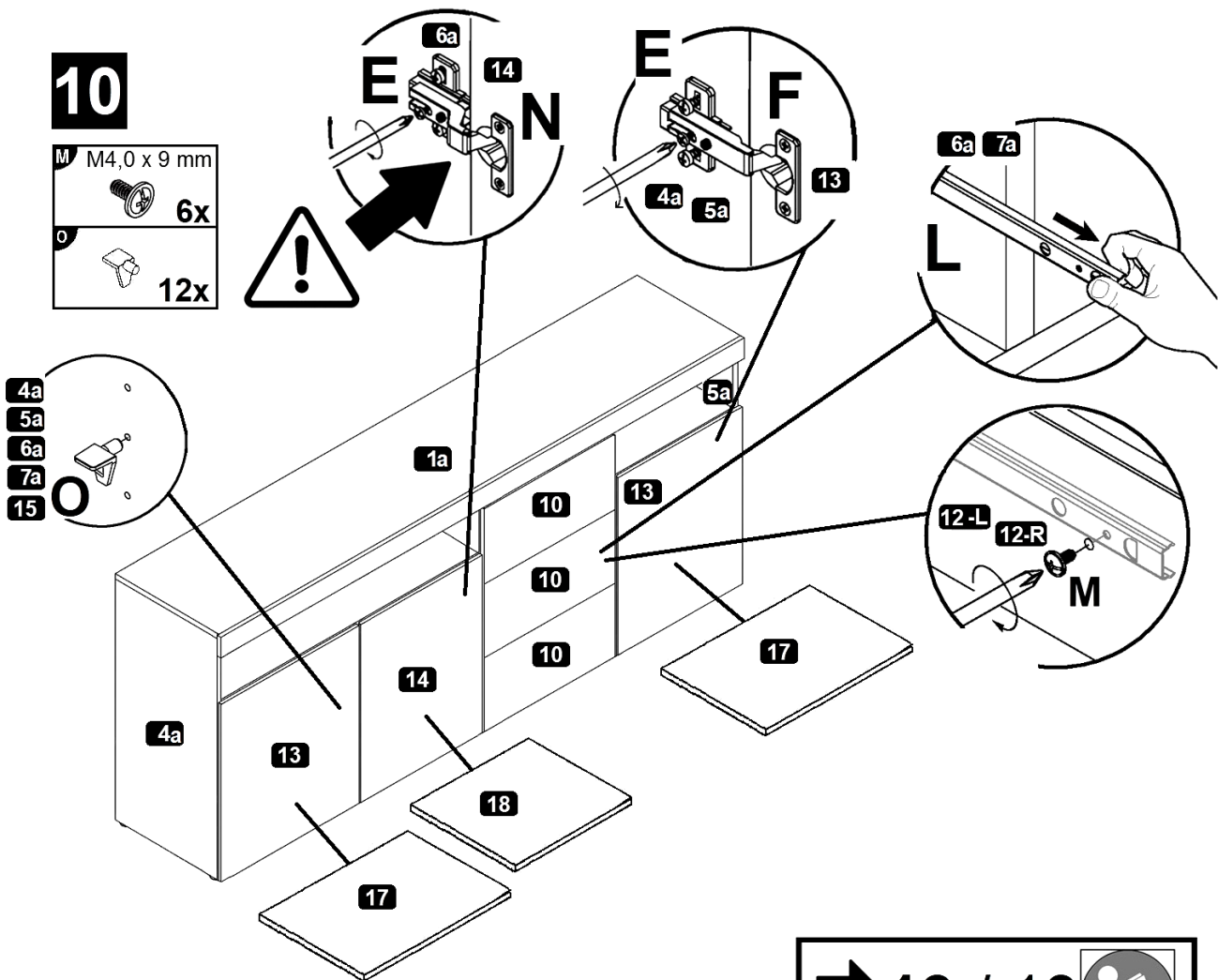

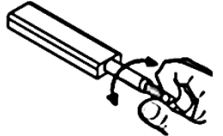

➔ 12 / 13 



 

- (D)** Push-To-Open einstellen
- (GB)** Adjusting the Push-To-Open
- (FR)** Régler les Push-To-Open
- (IT)** Sistemare Push-To-Open
- (NL)** Push-To-Open instellen
- (PL)** Nastawić Push-To-Open
- (CZ)** Vyrovnajte Push-To-Open
- (RO)** Nastavenie Push-To-Open
- (HU)** Állítsa be az Push-To-Open
- (SK)** Reglare Push-To-Open
- (TR)** Push-To-Open ayarlanması
- (RU)** Регулировка Push-To-Open

➔ 13 / 13 

- (D)** Türen einstellen
(Scharniere justieren)
- (GB)** Adjusting the doors
(adjusting the hinges)
- (FR)** Régler les portes
(ajuster les charnières)
- (IT)** Sistemare le porte
(regolare le cerniere)
- (NL)** Deuren instellen
(scharnieren afstellen)
- (PL)** Nastawić drzwi
(wyregulować zawiasy)
- (CZ)** Vyrovnajte dvířka
(seřid'te závěsy)
- (RO)** Nastavenie dverí
(nastavenie závesov)
- (HU)** Állítsa be az ajtókat
(állítsa be a zsanérokat)
- (SK)** Reglare uši
(ajustare balamale)
- (TR)** Kapıların ayarlanması
(menteselerin seviye ayarı)
- (RU)** Регулировка дверей
(регулировка шарнира)

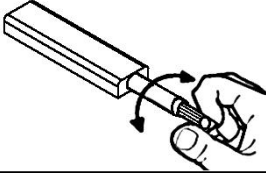
  	
<p>(D) Push-To-Open einstellen</p> <p>(GB) Adjusting the Push-To-Open</p> <p>(FR) Régler les Push-To-Open</p> <p>(IT) Sistemare Push-To-Open</p> <p>(NL) Push-To-Open instellen</p> <p>(PL) Nastawić Push-To-Open</p>	<p>(CZ) Vyrovnajte Push-To-Open</p> <p>(RO) Nastavenie Push-To-Open</p> <p>(HU) Állítsa be az Push-To-Open</p> <p>(SK) Reglare Push-To-Open</p> <p>(TR) Push-To-Open ayarlanması</p> <p>(RU) Регулировка Push-To-Open</p>

1.

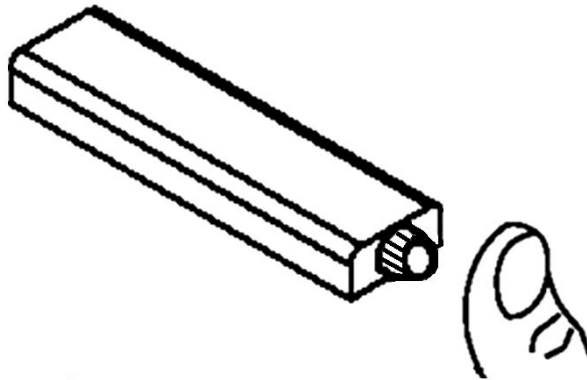

2.

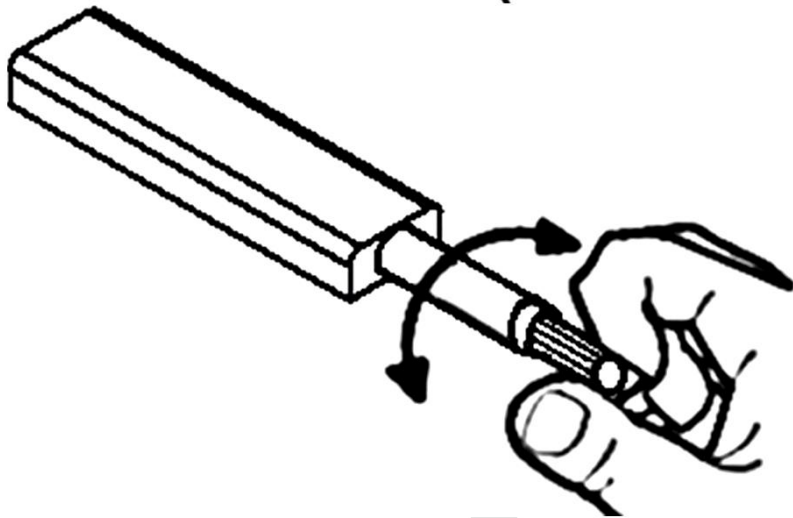

12

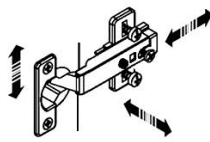

(D) Türen einstellen
(Scharniere justieren)

(GB) Adjusting the doors
(adjusting the hinges)

(FR) Régler les portes
(ajuster les charnières)

(IT) Sistemare le porte
(regolare le cerniere)

(NL) Deuren instellen
(scharnieren afstellen)

(PL) Nastawić drzwi
(wyregulować zawiasy)

(CZ) Vyrovnajte dvířka
(seřid'ťe závěsy)

(RO) Nastavenie dverí
(nastavenie závesov)

(HU) Állítsa be az ajtókat
(állítsa be a zsanérokot)

(SK) Reglare uši
(ajustare balamale)

(TR) Kapıların ayarlanması
(menteşelerin seviye ayarı)

(RU) Регулировка дверей
(регулировка шарнира)

