

Art. No. 43029529; 17056400; 42002533; 42002533; 41935433; 37929014; 65700240; 34706018; 25248639; 12841727; 28584302; 21209951; 36001353; 89037742; 48470851; 18281402; 58618140; 72701942; 58777106; 25227228; 58536156; 51589415; 63585248; 34688938; 71655243; 13273510; 15003955; 38698120; 55730913; 84400940; 86470303; 42522737; 77359242; 17412642; 60571109; 98386661; 99010952; 35661547; 71525833; 25429317; 48942647; 25403658; 35081359; 24034962; 52201956

Marseille

open corner

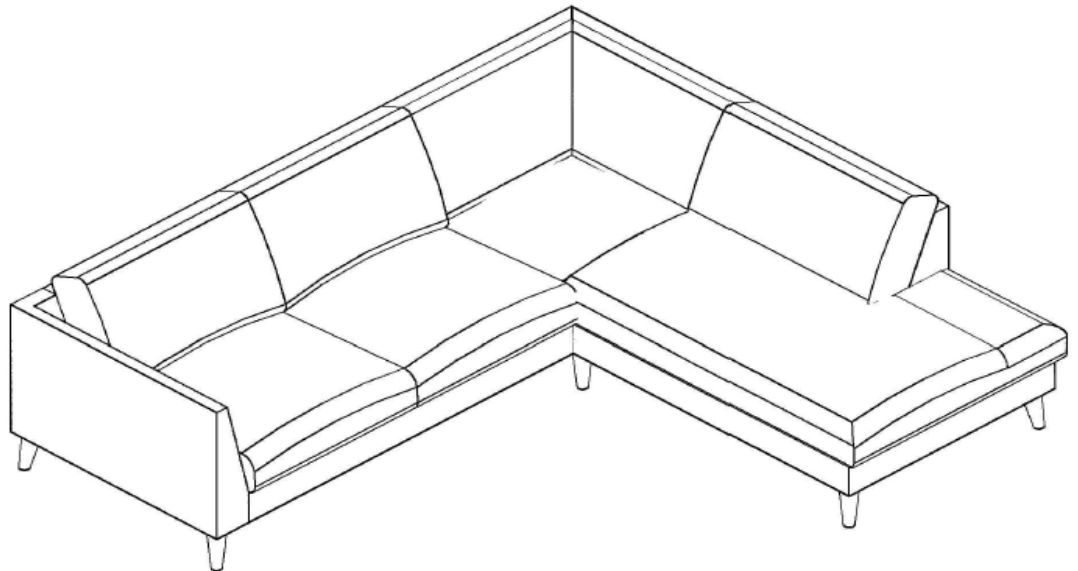

- | | |
|---|-------------------------------------|
| (D) Montageanleitung | (GB) Assembly instructions |
| (FR) Notice de montage | (IT) Istruzioni di montaggio |
| (NL) Handleiding voor de montage | (PL) Instrukcja montażu |
| (CZ) Montážní návod | (SK) Návod na montáž |
| (HU) Szerelési útmutató | (RO) Instrucțiuni de montaj |
| (TR) Montaj talimatı | (RU) Инструкция по монтажу |

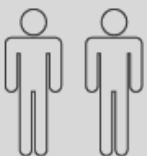

630kg-Max

LKZ 40937

**Service • Usługa • Обслуживание • Servizio • Un service
Serviciu • Služba • Servis • Szolgáltatás**



Name • Nom • Nome • Naam
• Nazwa • Název • Názov
• Név • Nume • Isim
• Название

Marseille

• Nr • No • N° • Номер • Č • Sz

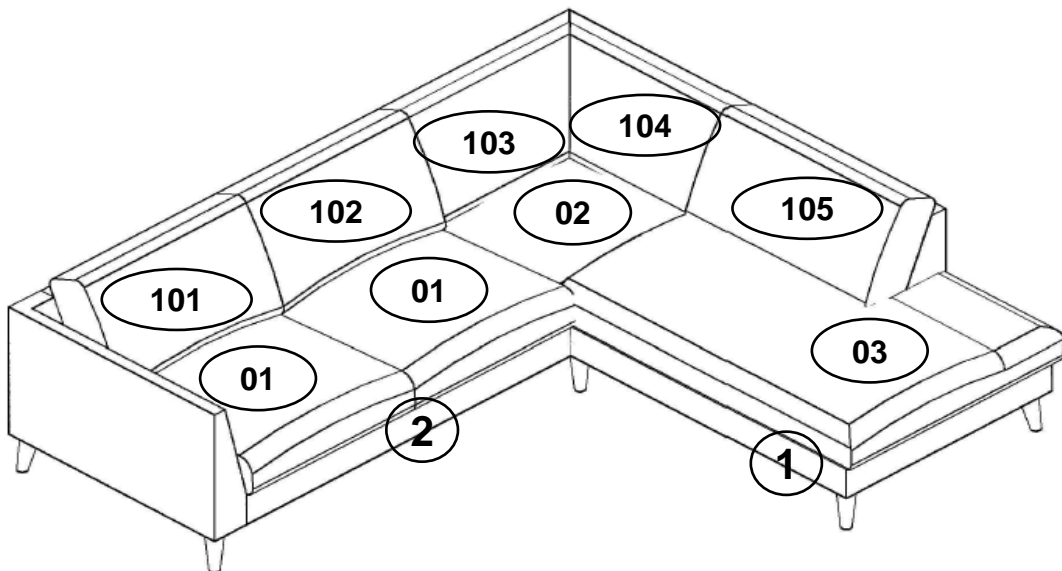
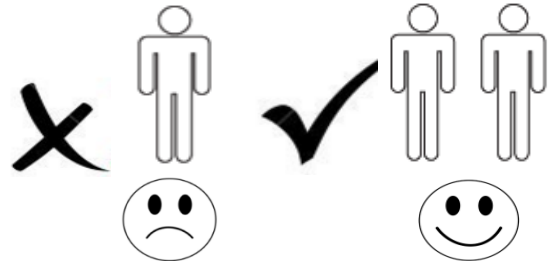
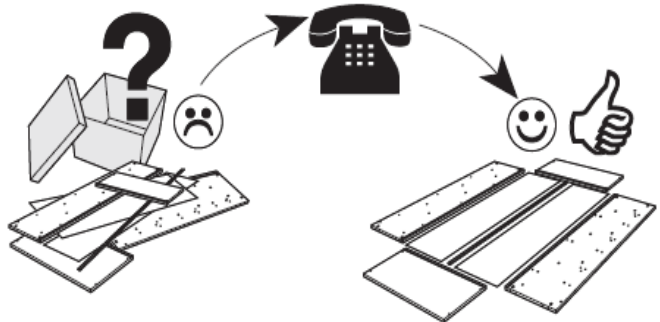
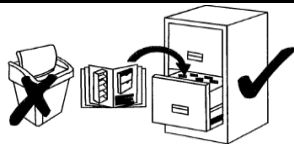
43029529; 17056400; 42002533; 42002533; 41935433; 37929014; 65700240;
34706018; 25248639; 12841727; 28584302; 21209951; 36001353; 89037742;
48470851; 18281402; 58618140; 72701942; 58777106; 25227228; 58536156;
51589415; 63585248; 34688938; 71655243; 13273510; 15003955; 38698120;
55730913; 84400940; 86470303; 42522737; 77359242; 17412642; 60571109;
98386661; 99010952; 35661547; 71525833; 25429317; 48942647; 25403658;
35081359; 24034962; 52201956



A		B		C	
H- 145 x7		x21, 5x30		x7	

1

