

D Montageanleitung

GB Assembly instructions

CZ Montážní návod

SK Návod na montáž

FR Notice de montage

IT Istruzioni di montaggio

HU Szerelési útmutató

RO Instrucțiunile de montaj

NL Handleiding voor de montage





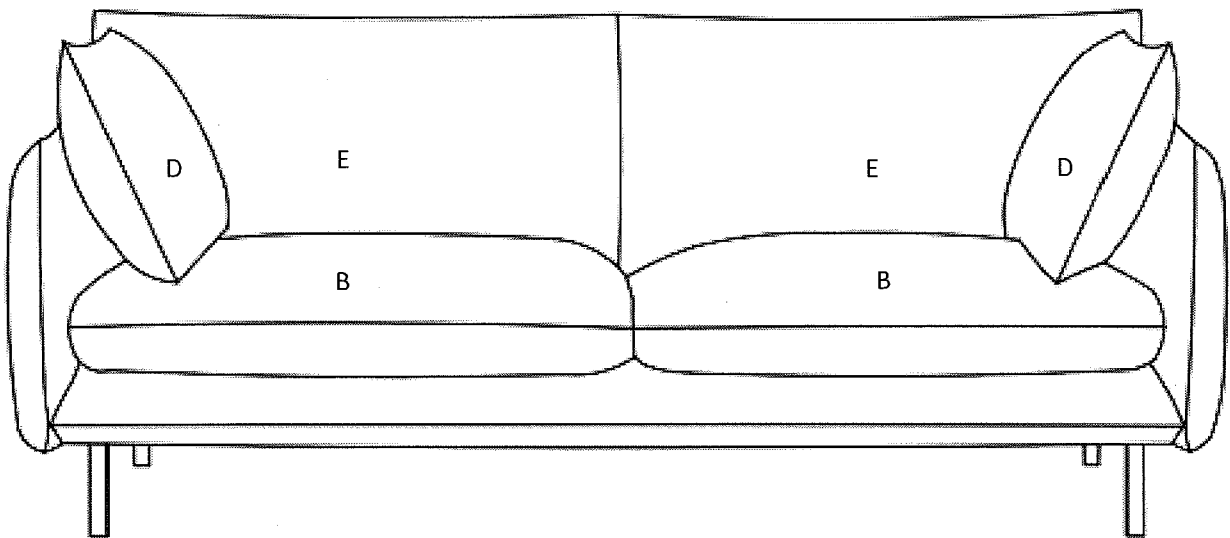
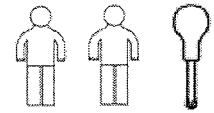

PL Instrukcja montażu

TR Montaj talimatı

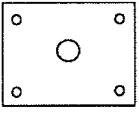
RU Инструкция по монтажу

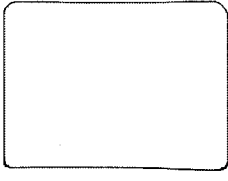
SOMBA 3

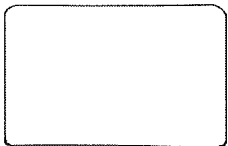

	4x		
	2x		2x
	4x		2x
			16x
			4x
A		B	
		C	
D		E	
F			
G			

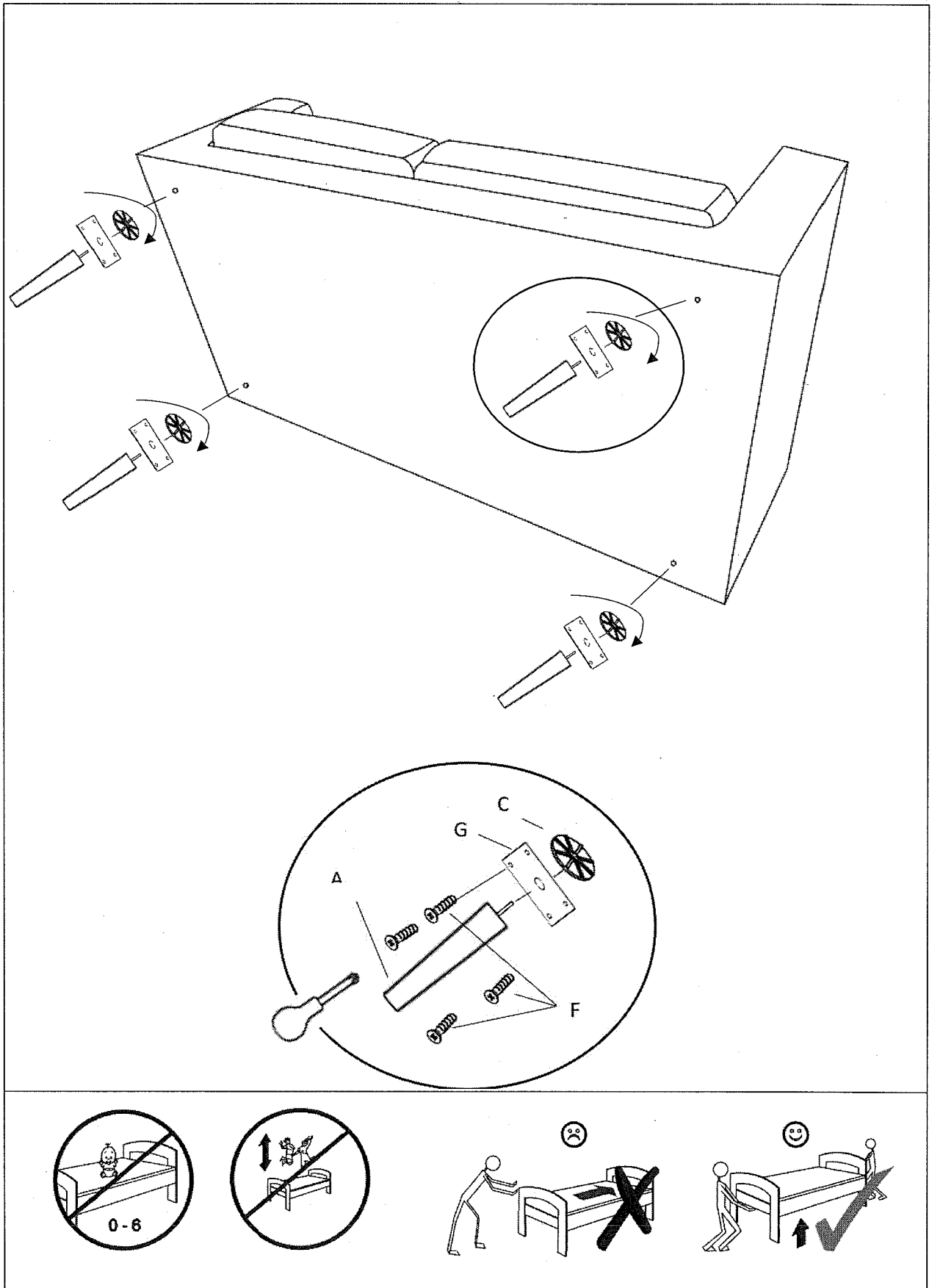





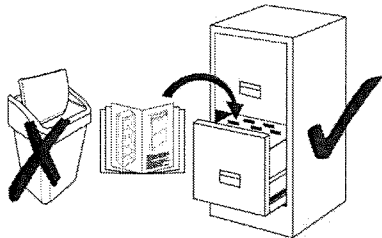
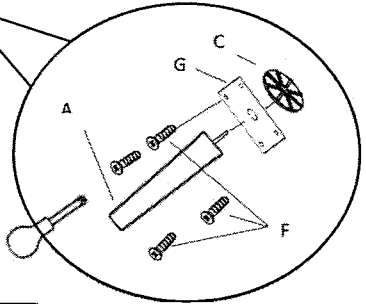
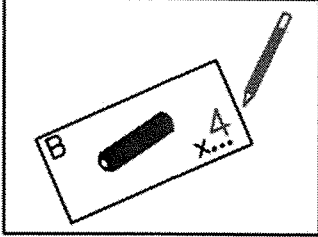
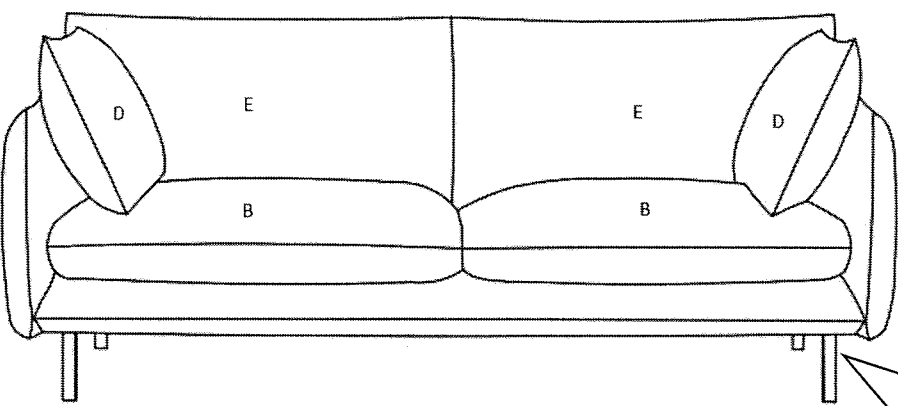
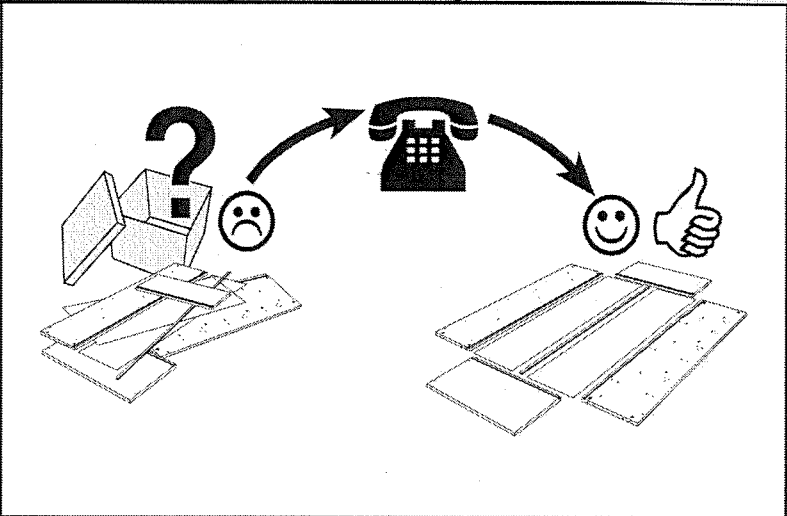

**Service • Assistenza • Dienstverlening • Serwis
 Servis • Szerviz • Сервисная служба**

Name • Naam • Nazwa • İsim • Название
SOMBA

Nr. • No. • Номер

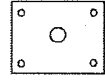
Тур • Туре • Тір • Тип
3

			
E	F	G	
			
A	B	C	D