

CARDOSO
2521-23(S.ÁGY)+
4010(RELAX)+
2021-23(AT)

- | | | | |
|-----------|--|-----------|---|
| D | MONTAGEANLEITUNG BEDIENUNGSANLEITUNG | GB | ASSEMBLY INSTRUCTIONS INSTRUCTION MANUAL |
| NL | HANDLEIDING VOOR DE MONTAGE GEBRUIKSAANWIJZING | PL | INSTRUKCJA MONTAŻU INSTRUKCJA OBSŁUGI |
| TR | MONTAJ TALIMATI KULLANIM KLAVUZU | RU | ИНСТРУКЦИЯ ПО МОНТАЖУ ИНСТРУКЦИЯ ПО ЭКСПЛУАТАЦИИ |
| RO | INSTRUCȚIUNI DE INSTALARE INSTRUCȚIUNI DE UTILIZARE | IT | ISTRUZIONI DI MONTAGGIO MANUALE DI ISTRUZIONI |
| FR | NOTICE DE MONTAGE MANUEL INSTRUCTIONS | SK | MONTÁŽNY NÁVOD NÁVOD NA POUŽITIE |
| HU | SZERELÉSI UTASÍTÁSOK KEZELÉSI UTASÍTÁS | CZ | MONTÁŽNÍ NÁVOD NÁVOD K POUŽITÍ |
| SI | NAVODILA ZA MONTAŽO NAVODILA ZA UPORABO | PT | INSTRUÇÕES DE MONTAGEM MANUAL DO USUÁRIO |
| ES | INSTRUCCIONES DE MONTAJE MANUAL DEL USUARIO | HR | UPUTE ZA MONTAŽU UPUTE ZA UPOTREBU |

Service · Dienstverlening · Servis · Servis · Сервисная служба · Serviciu · Services · Servizio
 ·Servisný list · Szolgáltatás · Servisní list

Name · Naam · Nazwa · İsim · Название · Nume · Nome · Názov · Názov ·
 Název · Neve

CARDOSO

Typ · Type · Tip · Тип · Tipo · Típus

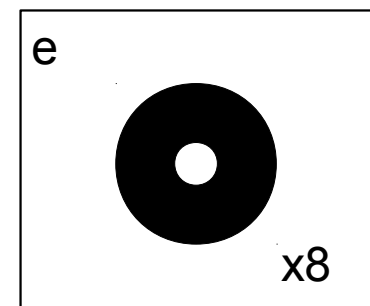
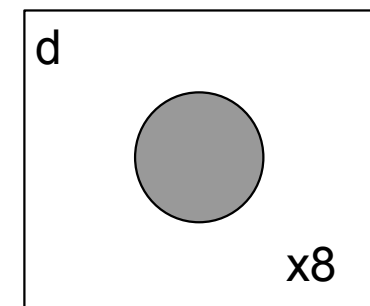
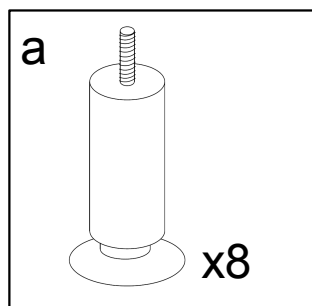
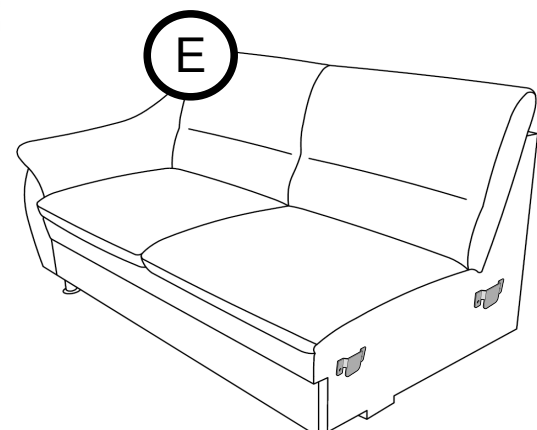
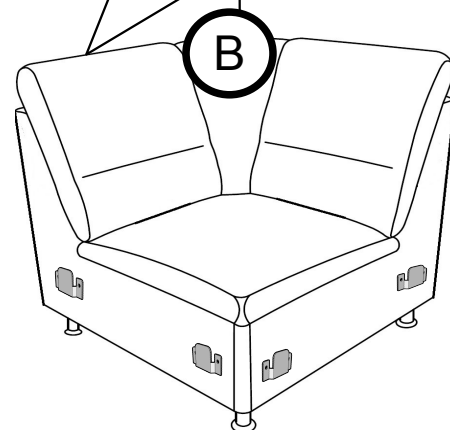
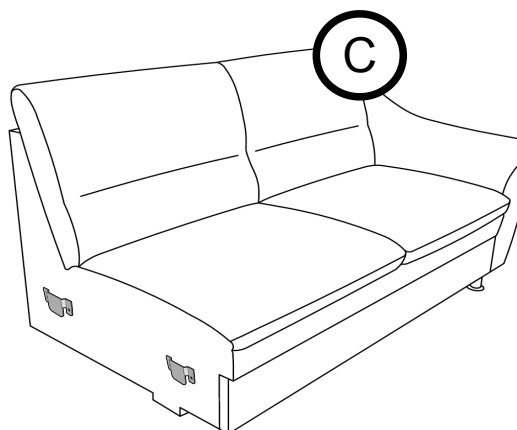
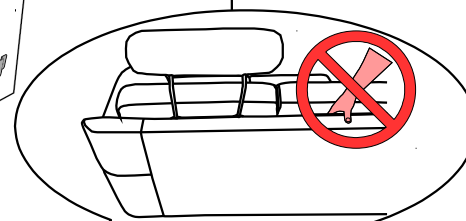
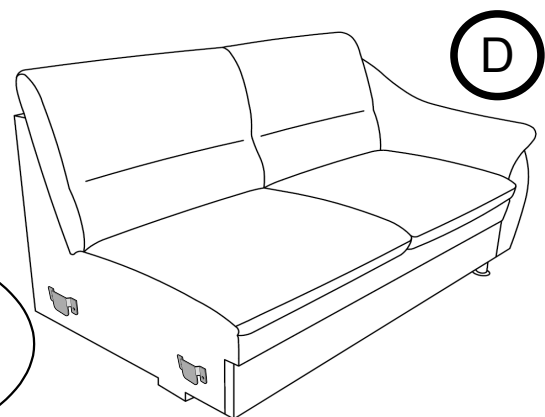
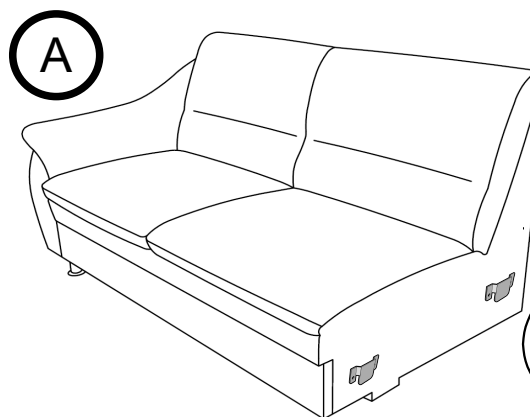
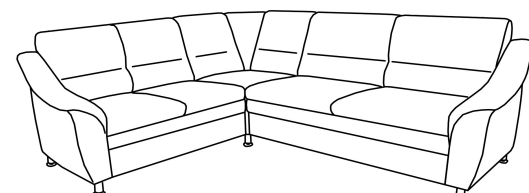
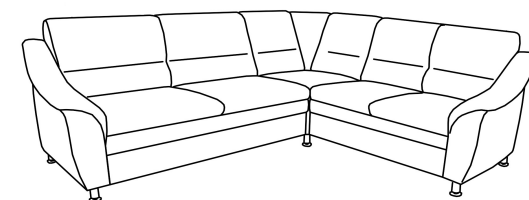
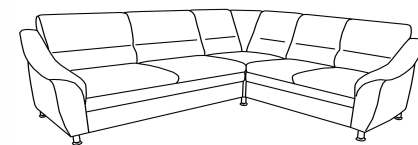
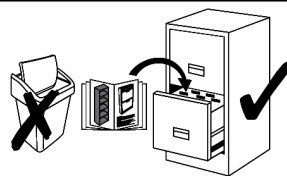

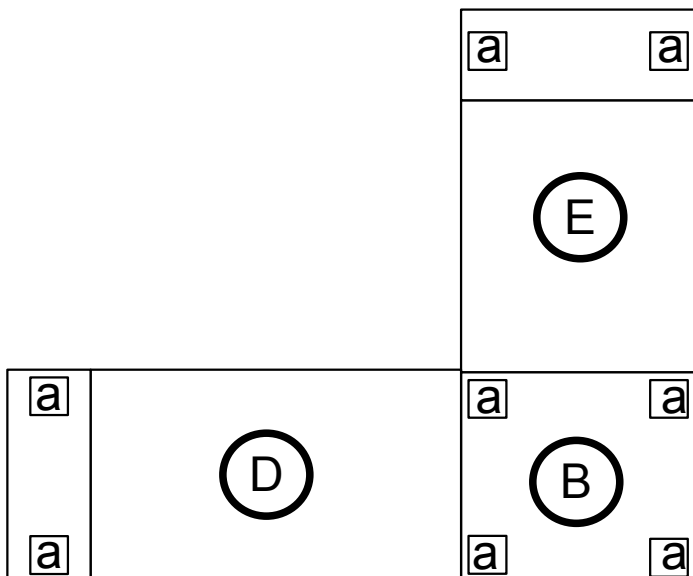
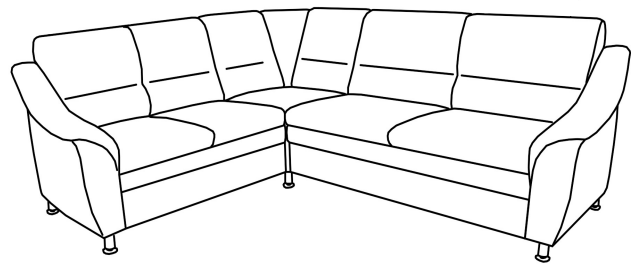
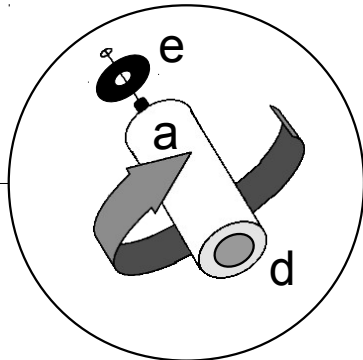
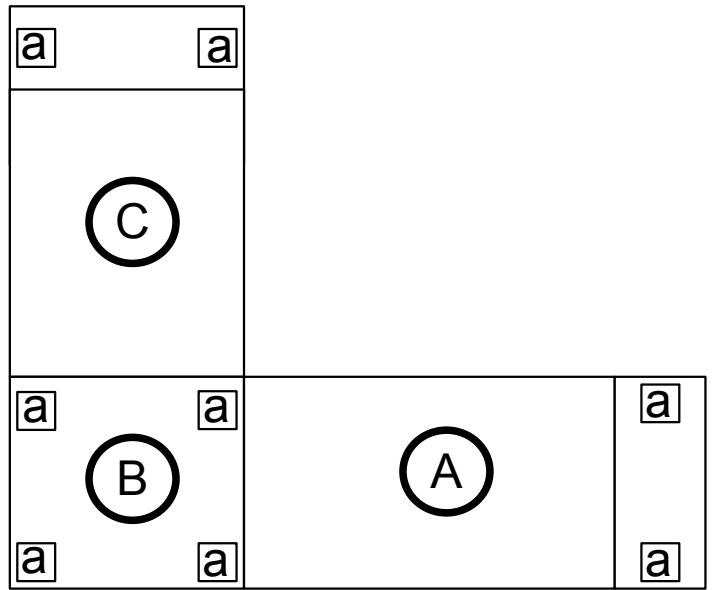
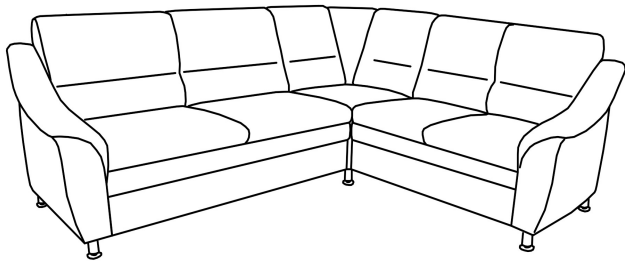
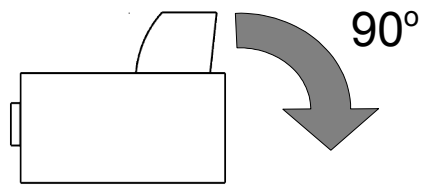

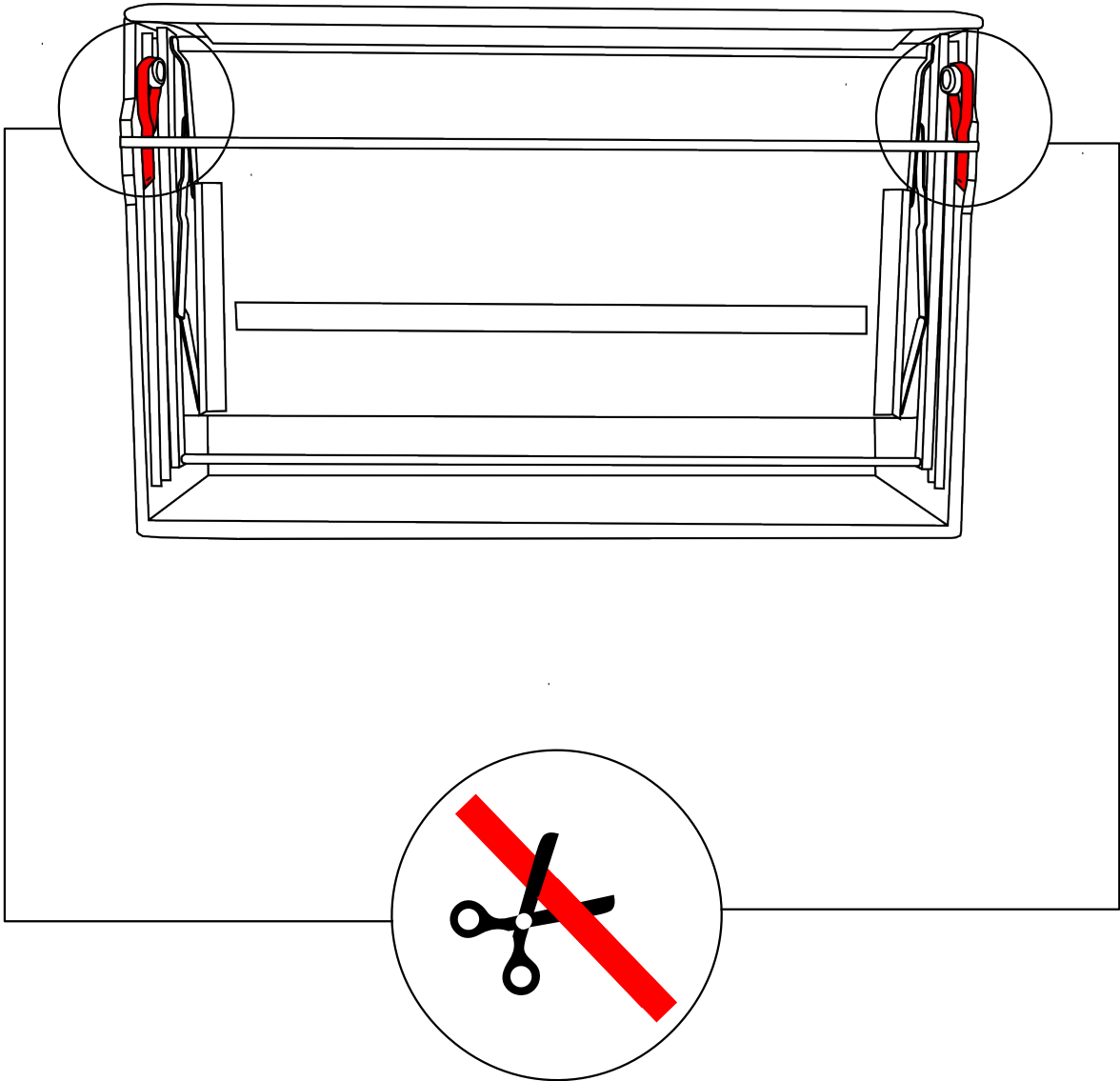
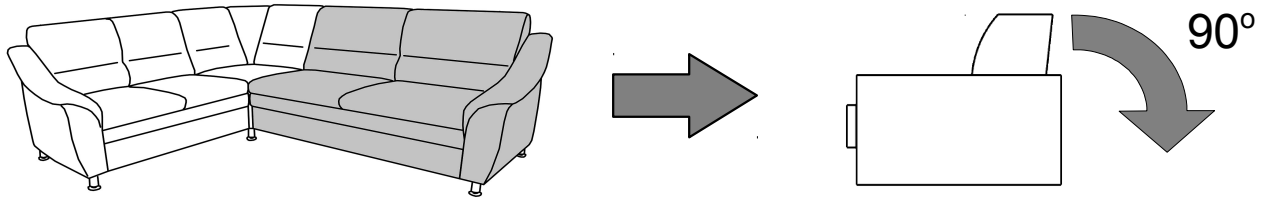

1

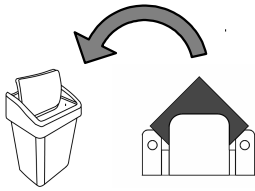

2

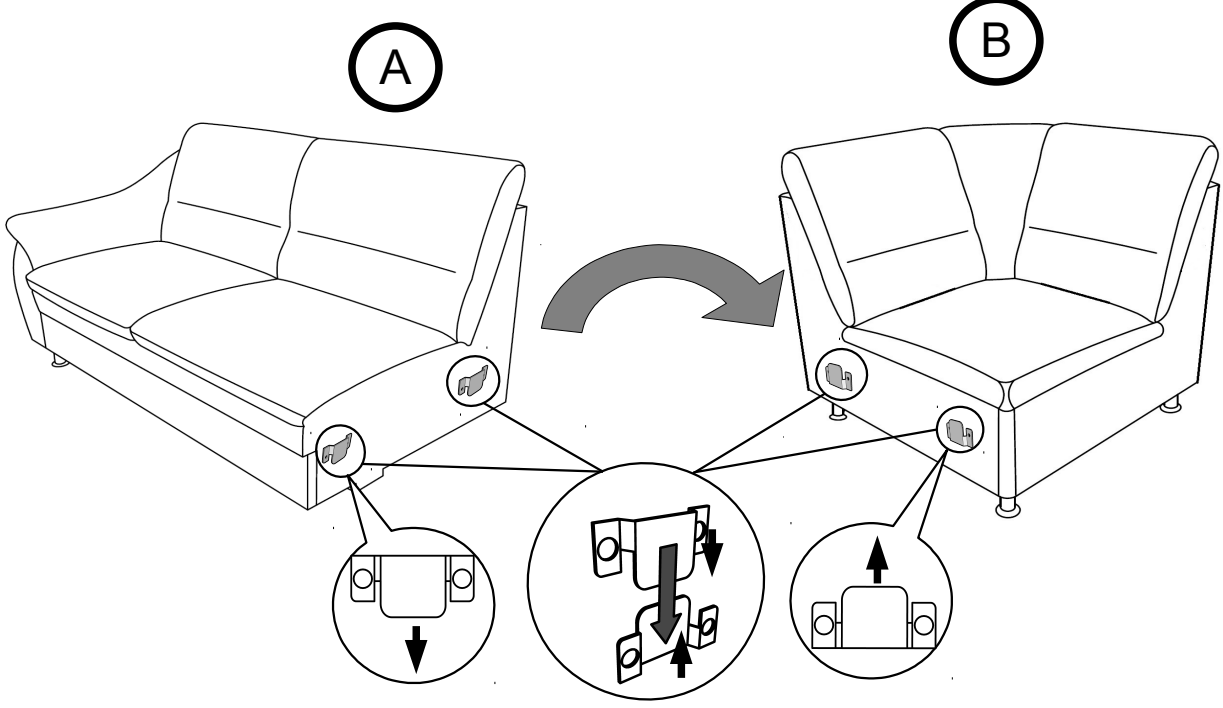

3

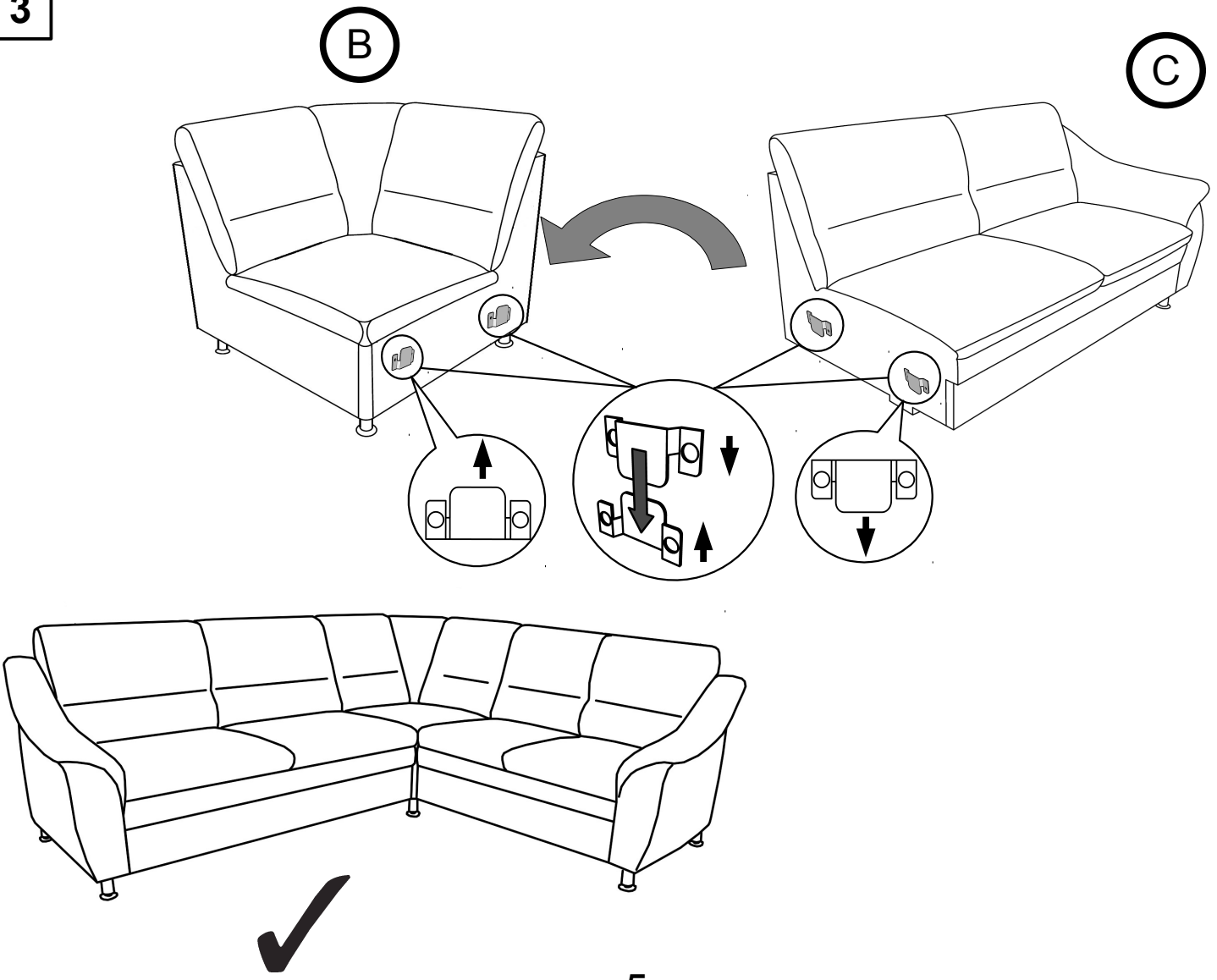

4

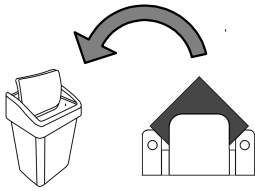

5

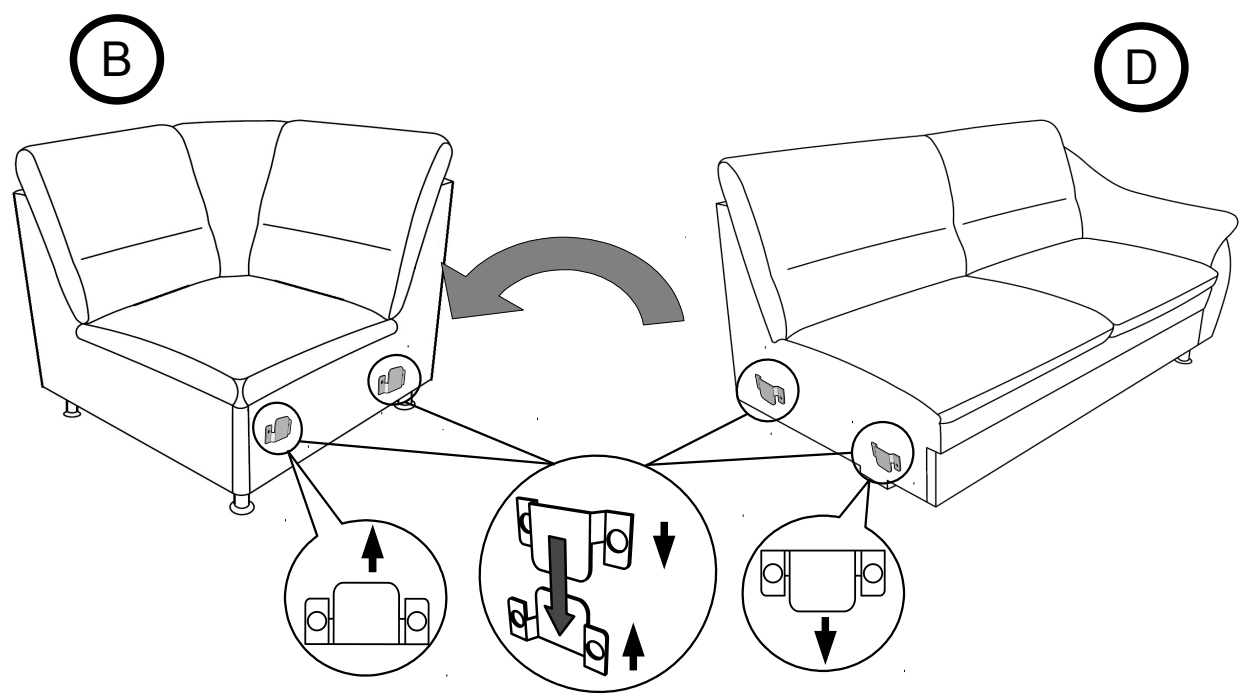

6

