

**D** MONTAGEANLEITUNG  
BEDIENUNGSANLEITUNG

**NL** HANDLEIDING VOOR DE MONTAGE  
GEBRUIKSAANWIJZING

**TR** MONTAJ TALIMATI  
KULLANIM KLAVUZU

**RO** INSTRUȚIUNI DE INSTALARE  
INSTRUȚIUNI DE UTILIZARE

**FR** NOTICE DE MONTAGE  
MANUEL INSTRUCTIONS

**HU** KÖZGYŰLÉS UTASÍTÁSOK  
KEZELÉSI UTASÍTÁS

**SI** NAVODILA ZA MONTAŽO  
NAVODILA ZA UPORABO

**ES** INSTRUCCIONES DE MONTAJE  
MANUAL DEL USUARIO

**GB** ASSEMBLY INSTRUCTIONS  
INSTRUCTION MANUAL

**PL** INSTRUKCJA MONTAŻU  
INSTRUKCJA OBSŁUGI

**RU** ИНСТРУКЦИЯ ПО МОНТАЖУ  
ИНСТРУКЦИЯ ПО ЭКСПЛУАТАЦИИ

**IT** ISTRUZIONI DI MONTAGGIO  
MANUALE DI ISTRUZIONI

**SK** MONTÁŽNY NÁVOD  
NÁVOD NA POUŽITIE

**CZ** MONTÁŽNÍ NÁVOD  
NÁVOD K POUŽITÍ

**PT** INSTRUÇÕES DE MONTAGEM  
MANUAL DO USUÁRIO

**HR** UPUTE ZA MONTAŽU  
UPUTE ZA UPOTREBU

**F**

L

R

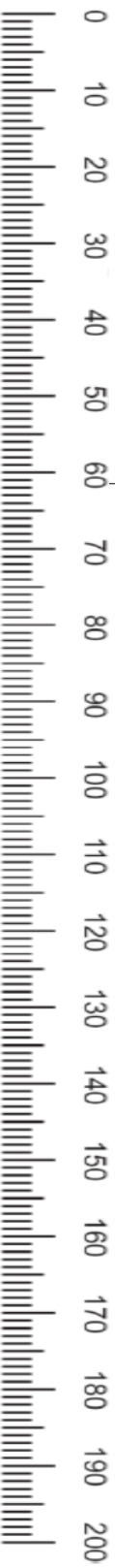
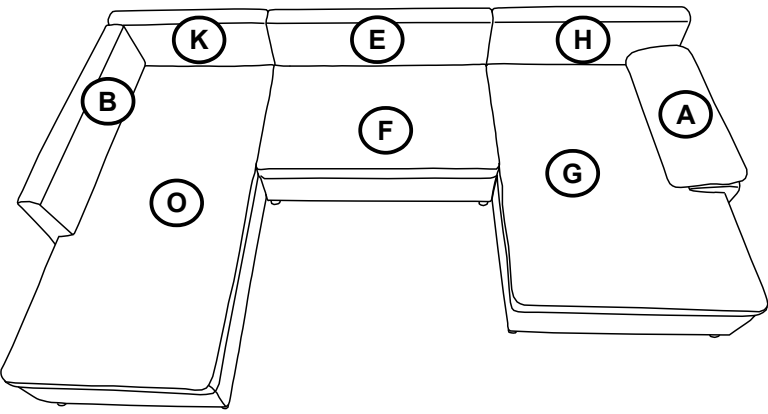
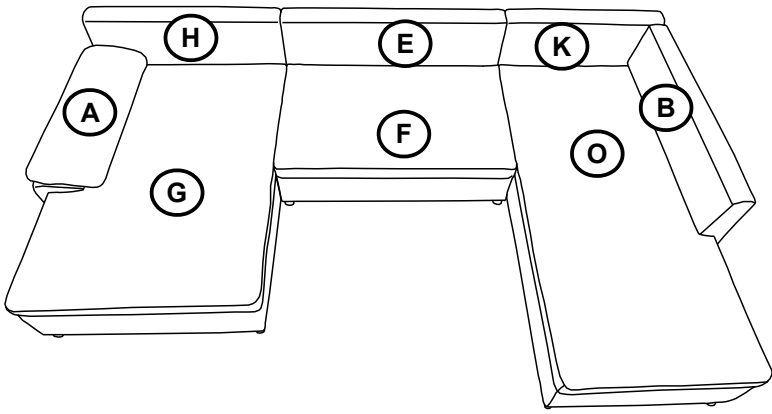

L X2

M X2

S X2

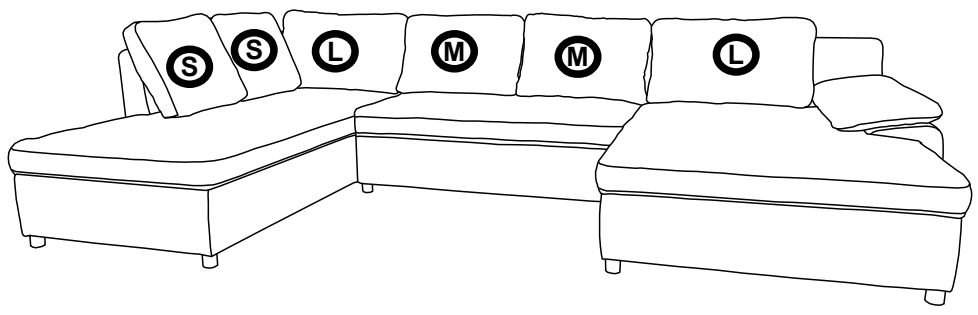

<b>a</b> X4	<b>b</b> M8*80 X11	<b>c</b> M8 X11	<b>d</b> M10*30 X11	<b>e</b> M6*35 X8	<b>f</b> H-50 X10	<b>g</b> H-50 X6	<b>h</b> 5*50 X16	<b>i</b> X16	<b>m</b> M8 X11
----------------	-----------------------	--------------------	------------------------	----------------------	----------------------	---------------------	----------------------	-----------------	--------------------

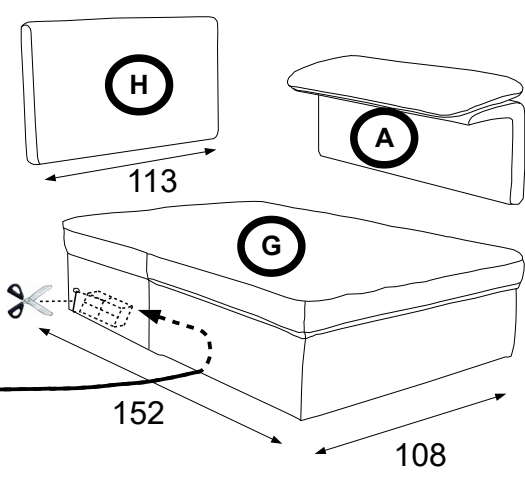
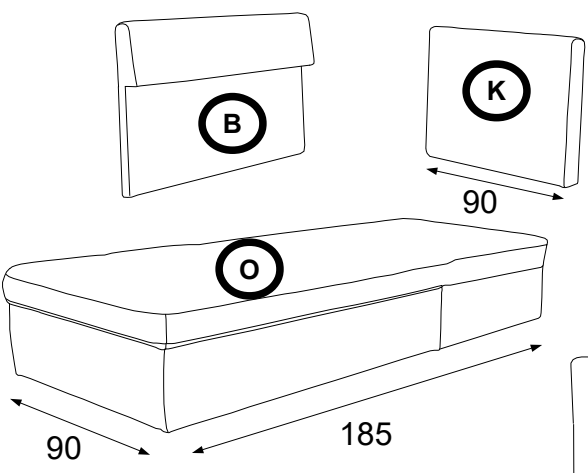

L

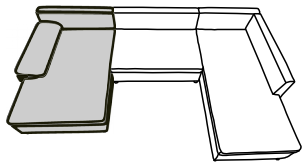

2

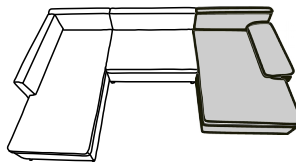

R

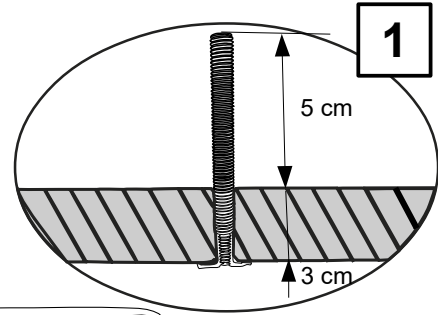
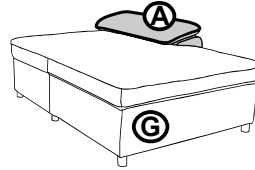
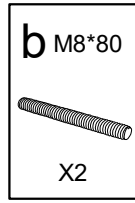
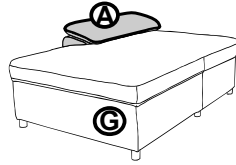
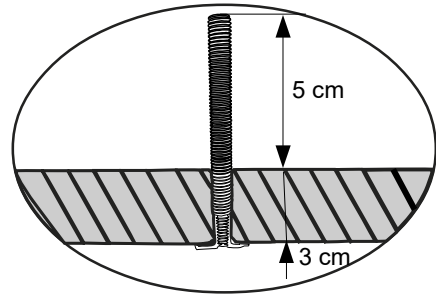

1

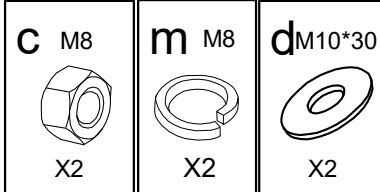
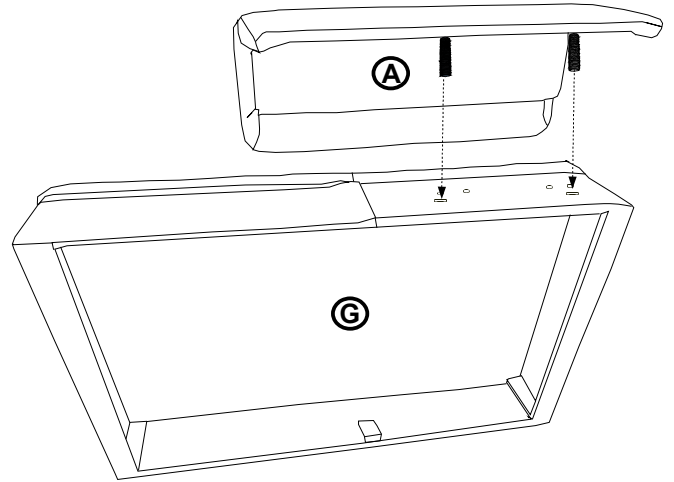
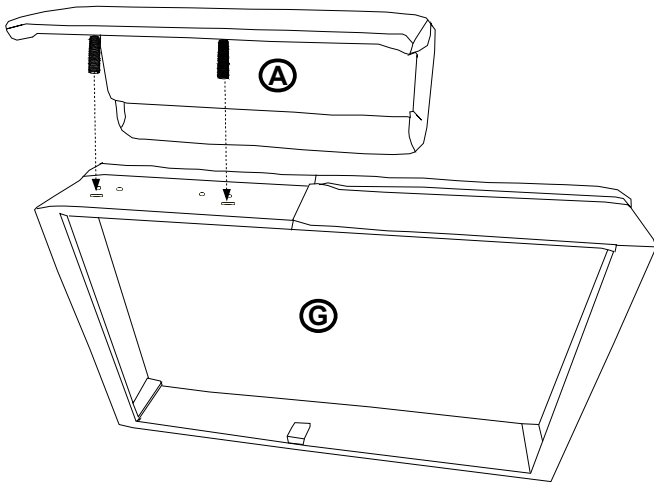
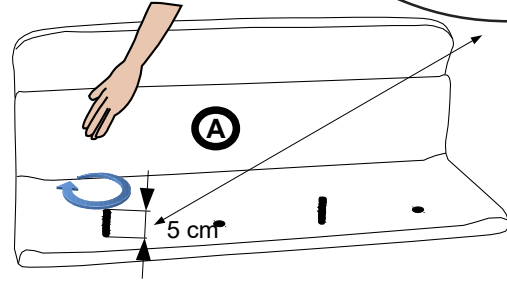
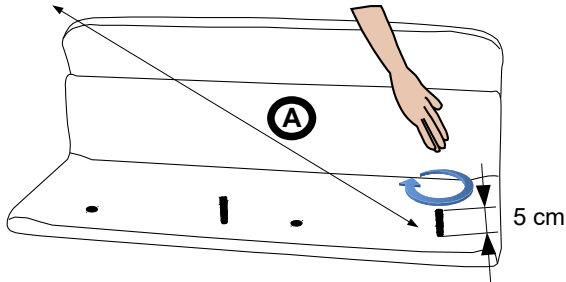

2

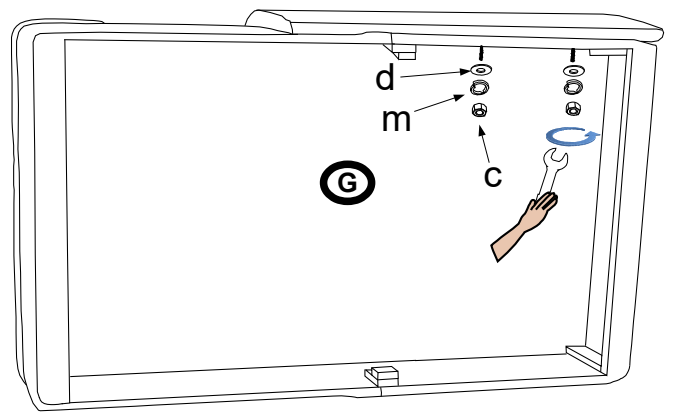
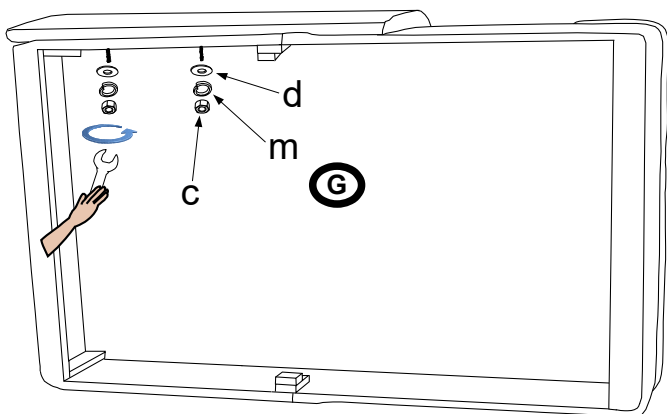

L

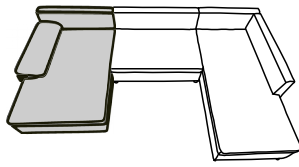

3

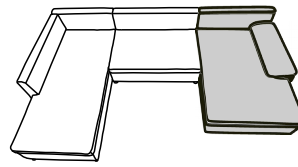

R

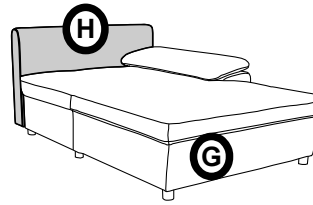
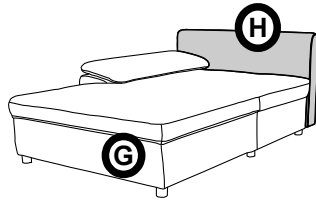

3

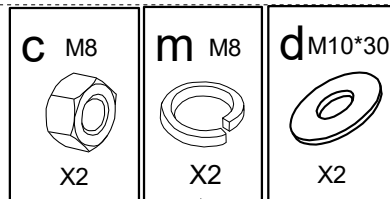
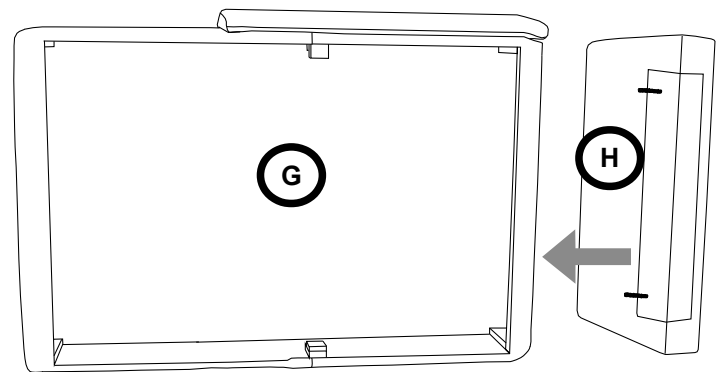
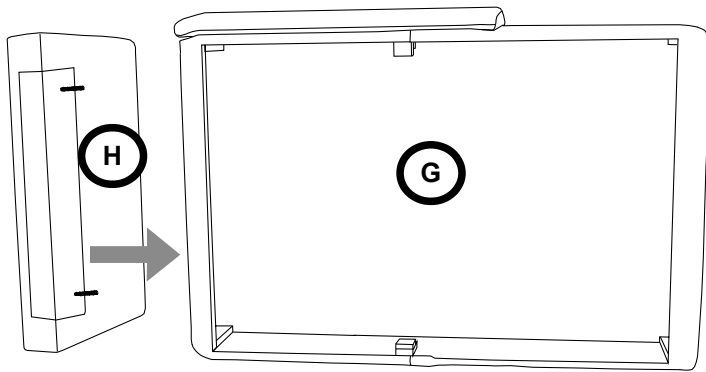
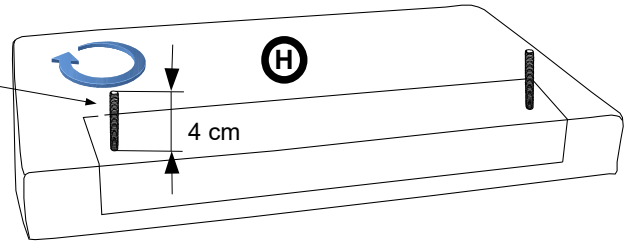
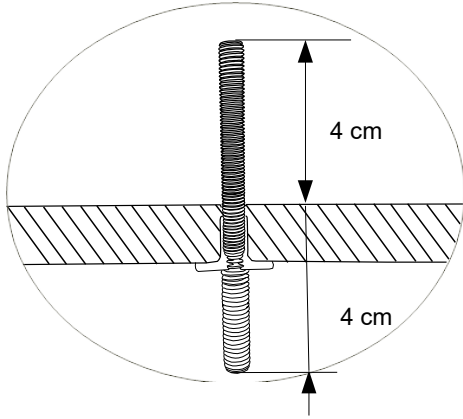
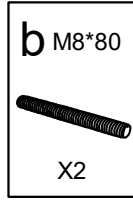

4

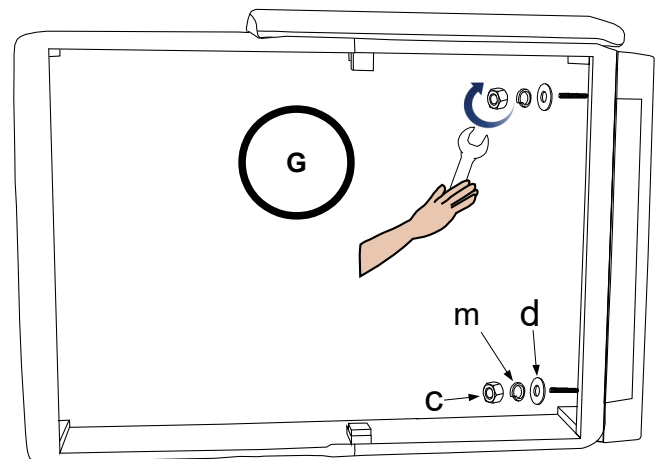
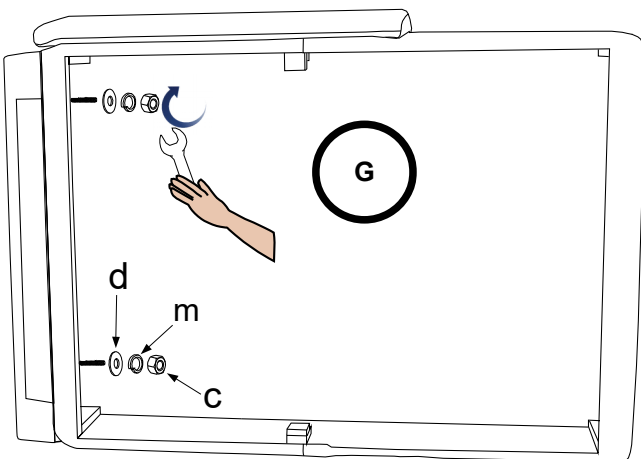

L

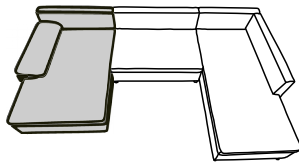

4

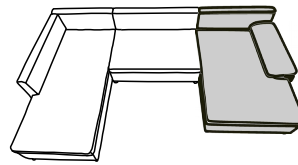

R

5

- f** H-50 X4
- g** H-50 X2
- h** 5\*50 X6
- i** X6

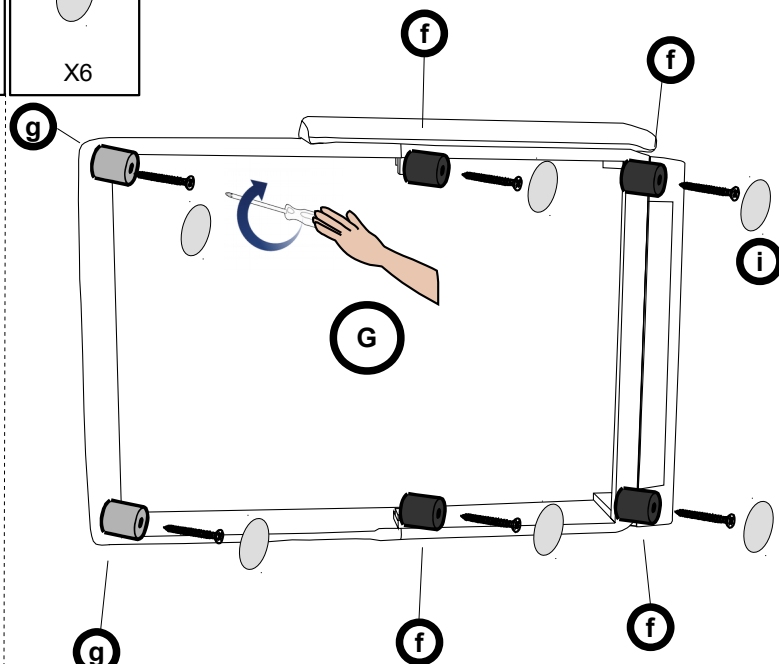
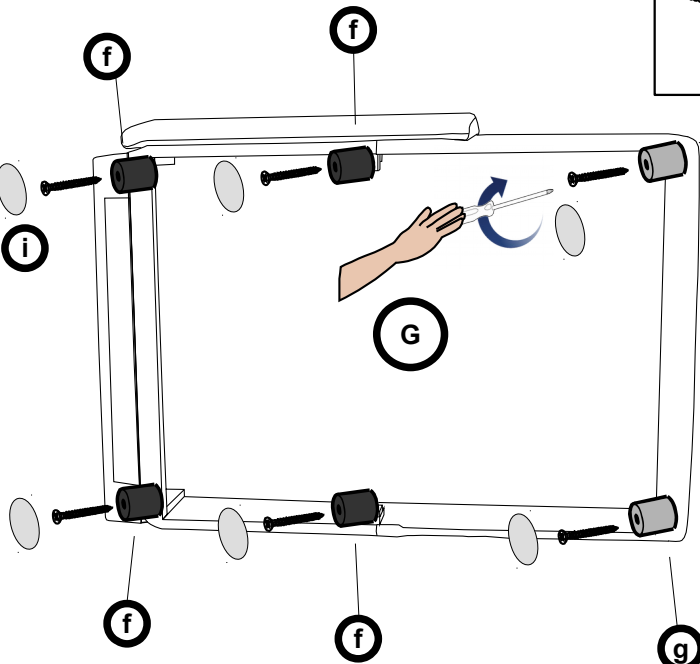

6

- a** X2
- e** M6\*35 X4

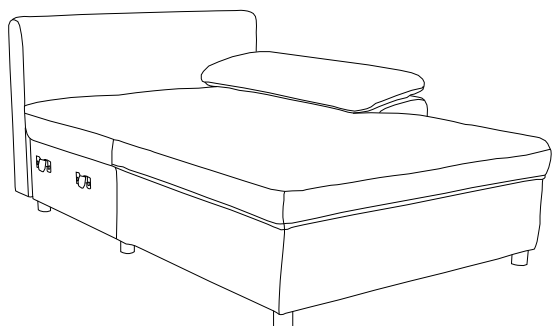
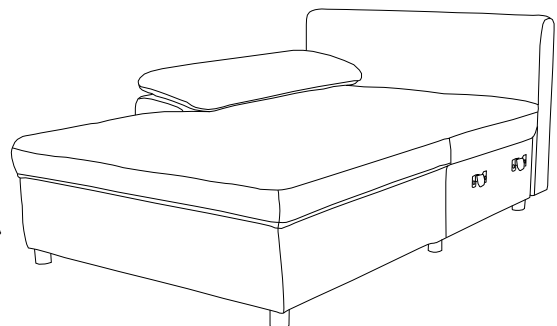
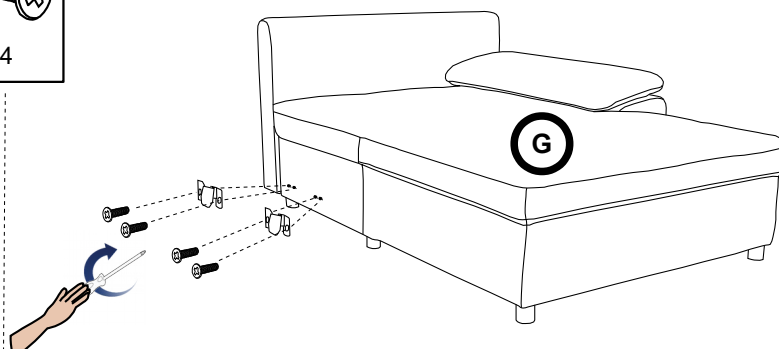
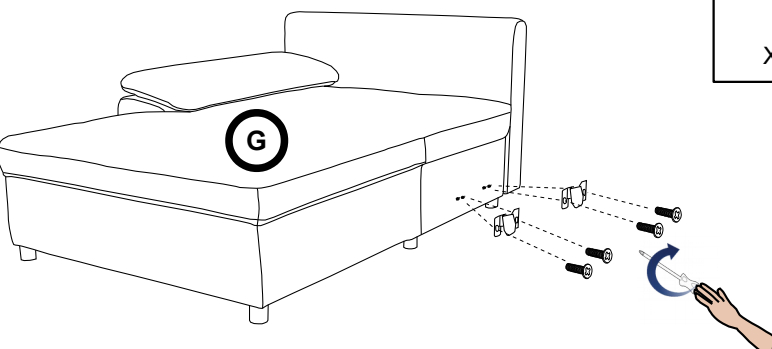

L

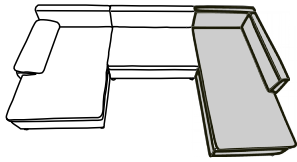

5

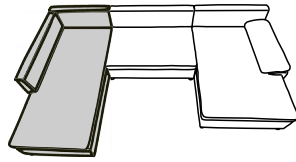

R

7

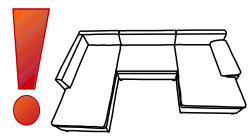
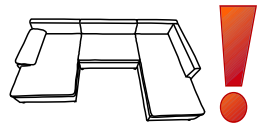
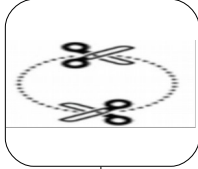
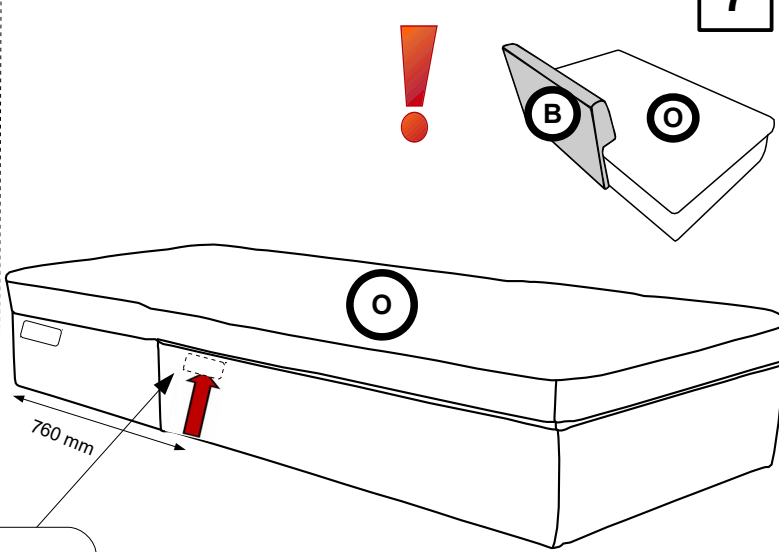
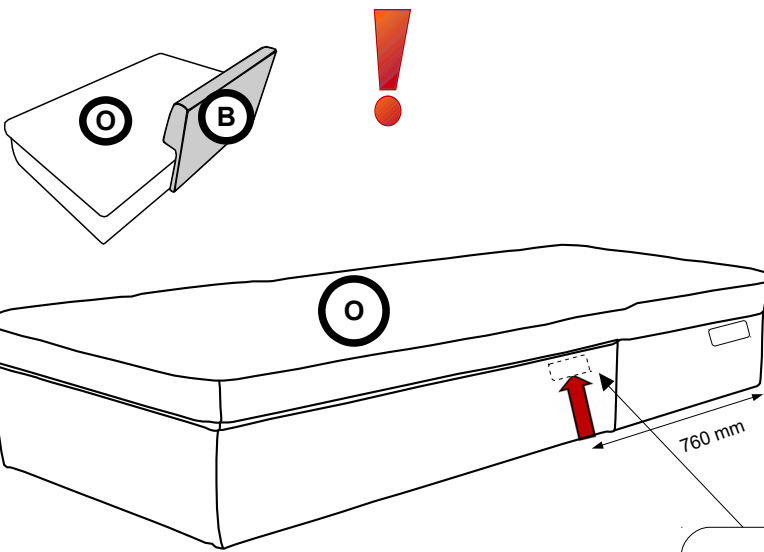

8

b M8\*80  
X2

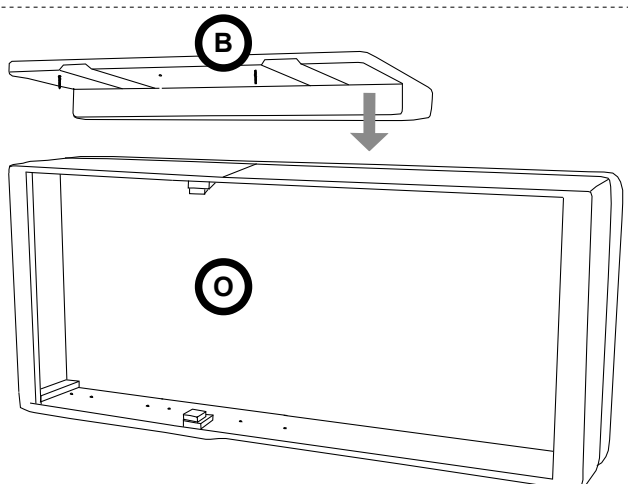
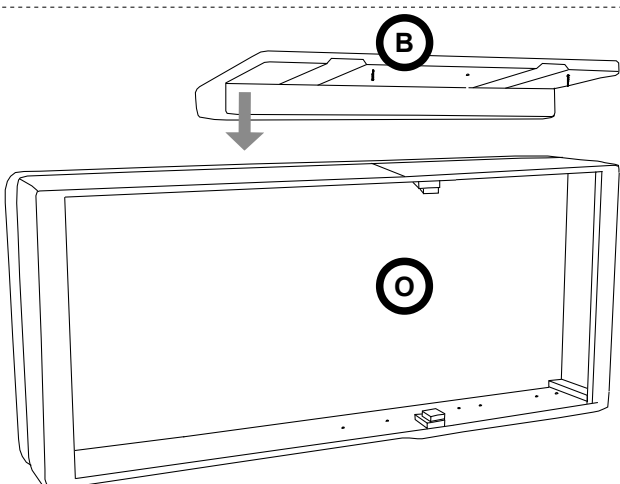
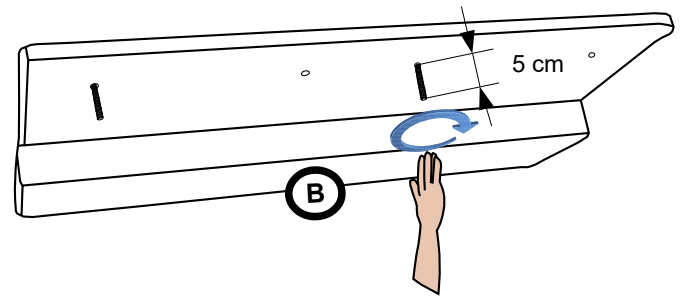
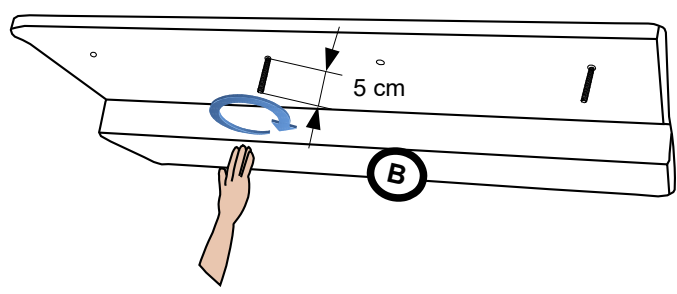

L

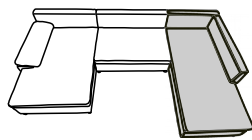

6

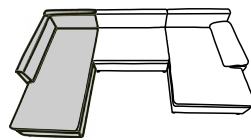

R

**c** M8



X2

**m** M8



X2

**d** M10\*30



X2

9

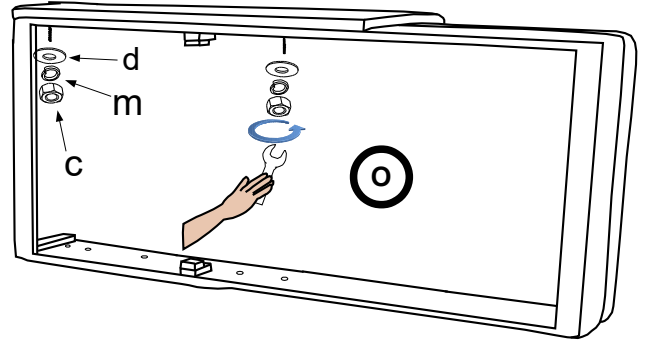
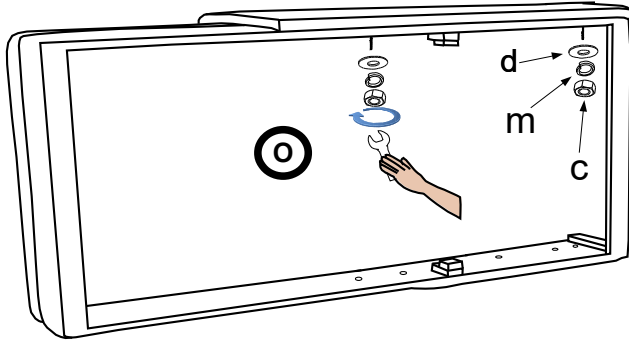

10

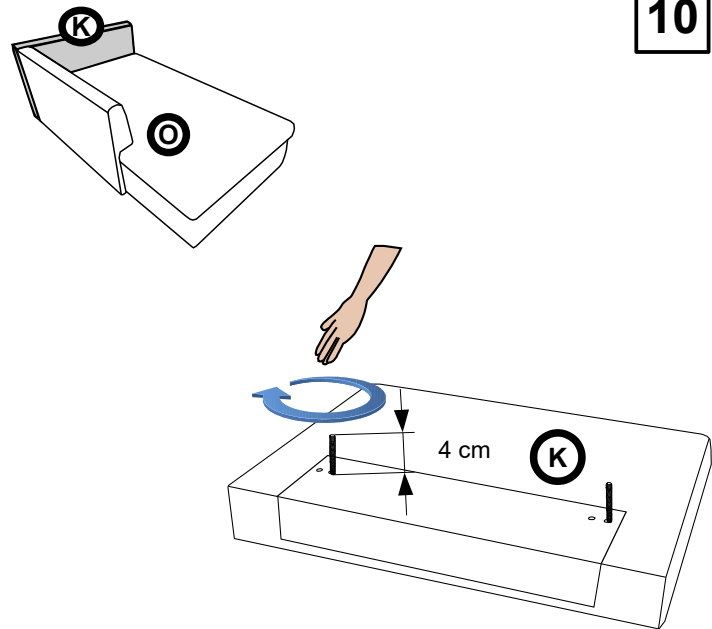
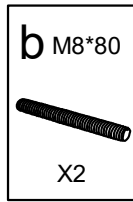
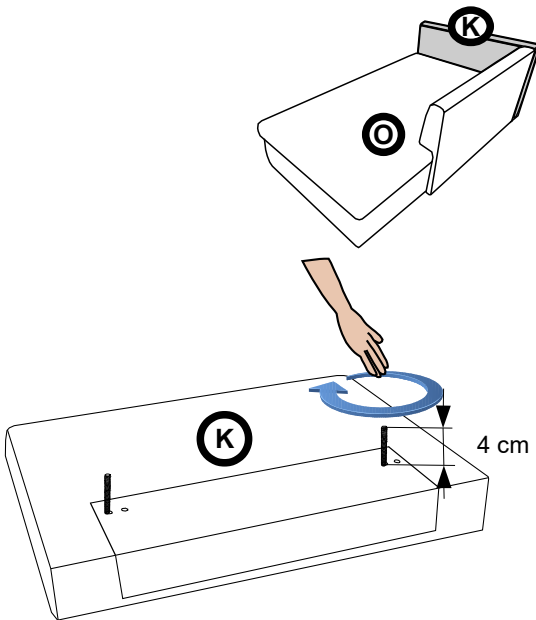

11

**c** M8



X2

**m** M8



X2

**d** M10\*30



X2

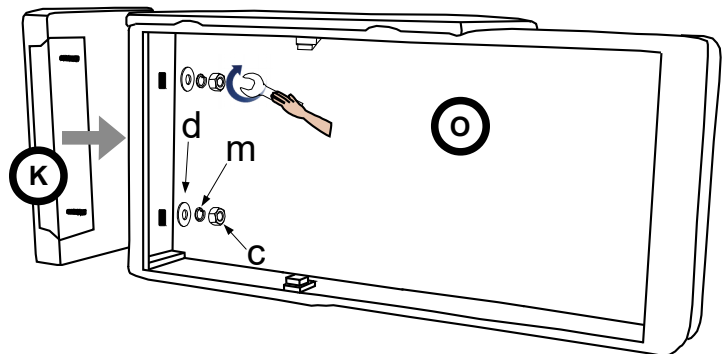
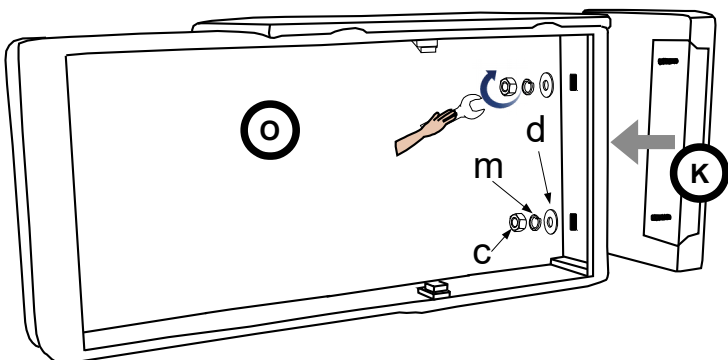

L

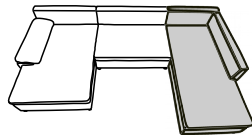

7

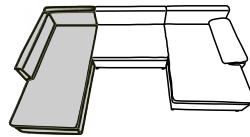

R

12

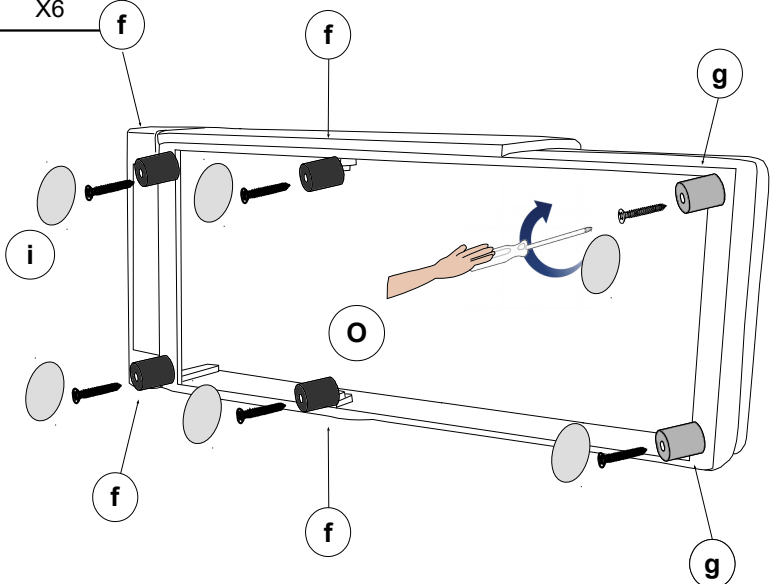
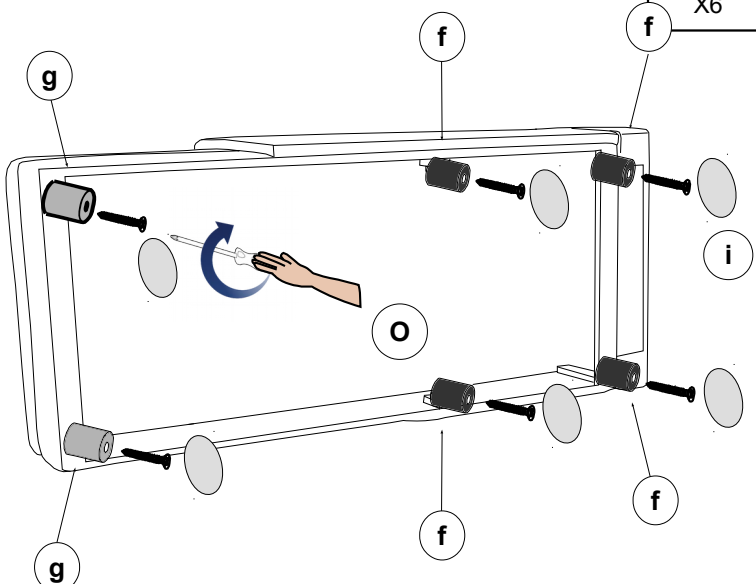
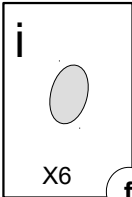
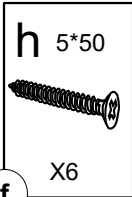
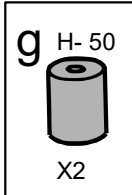
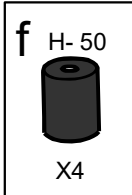

13

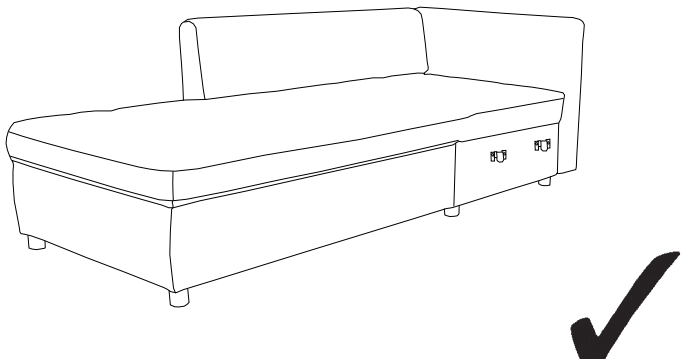
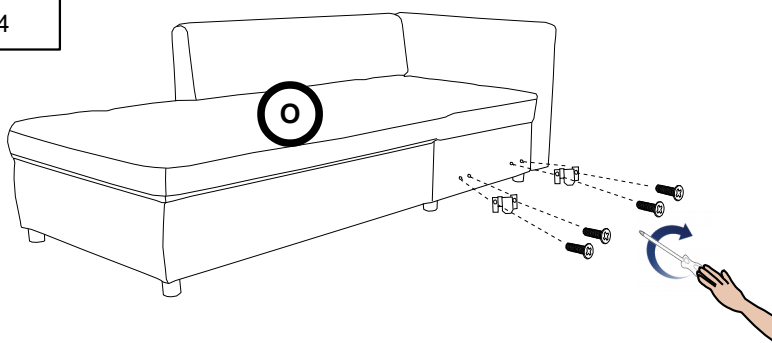
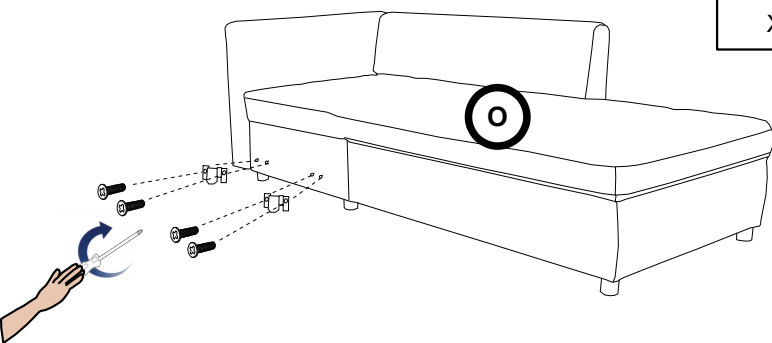
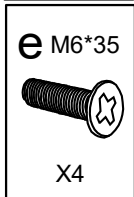
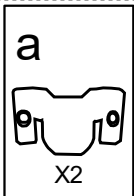



L

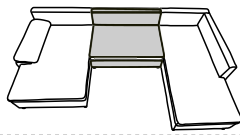

8

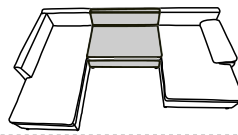

R

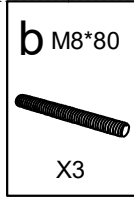
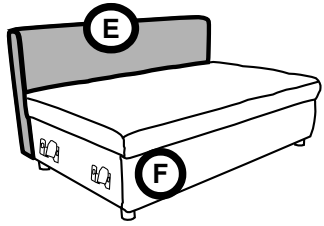

14

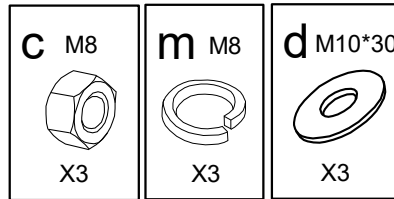
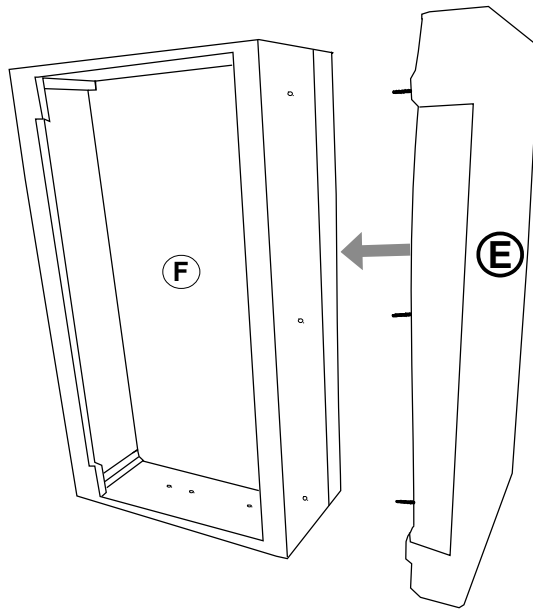
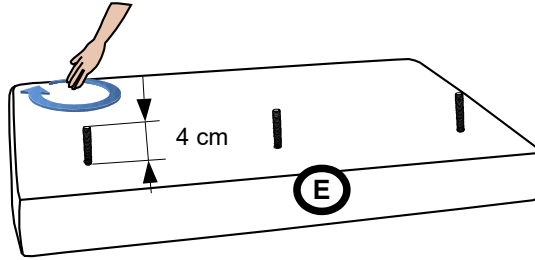

15

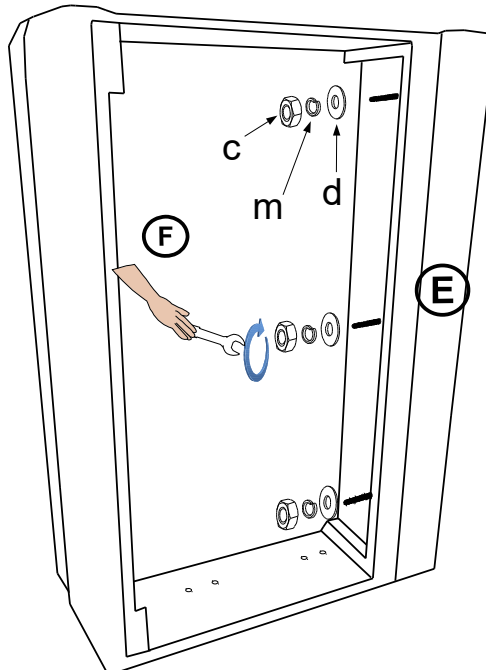

L

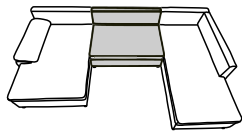

9

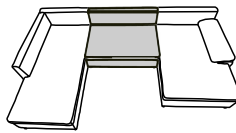

R

16

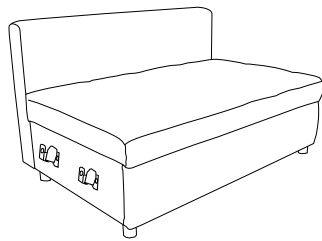
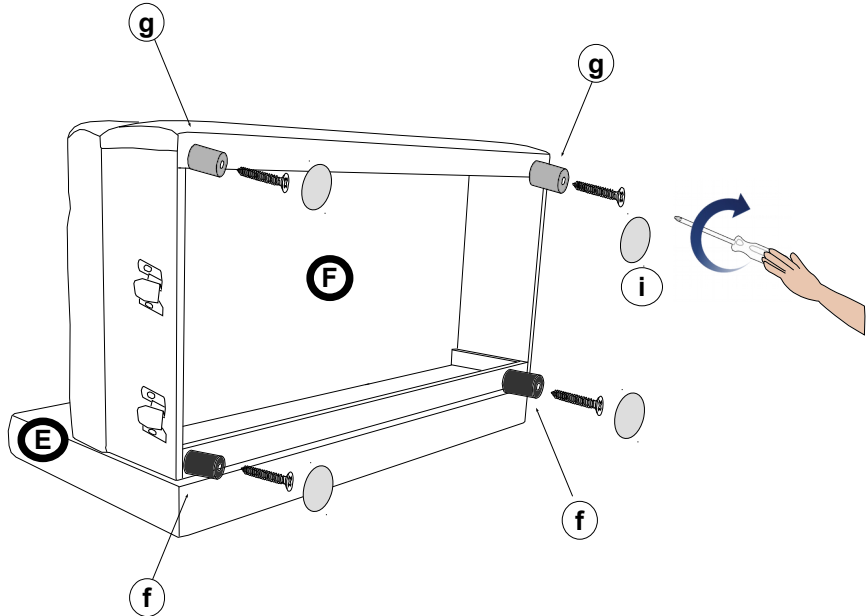
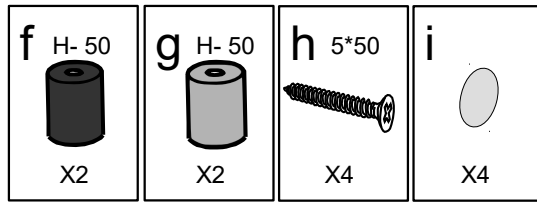

17

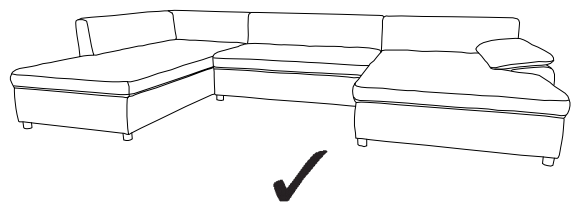
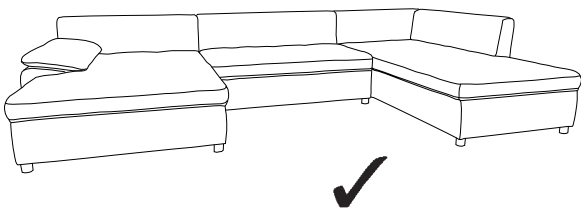
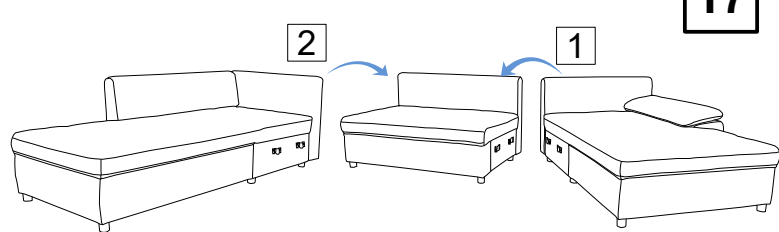
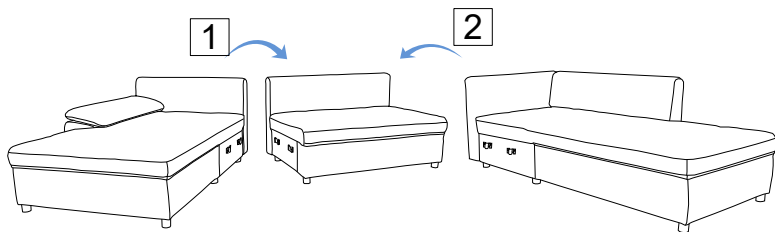

Name · Naam · Nazwa · İsim · Название · Nume · Nome · Názov · Názov ·  
Název · Neve

Labene

Typ · Type · Tip · Тип · Típo · Típus

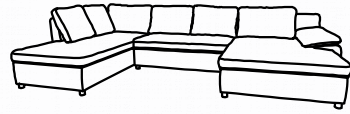
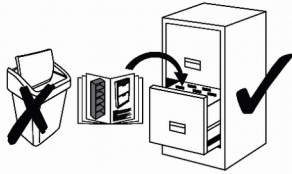

**L**

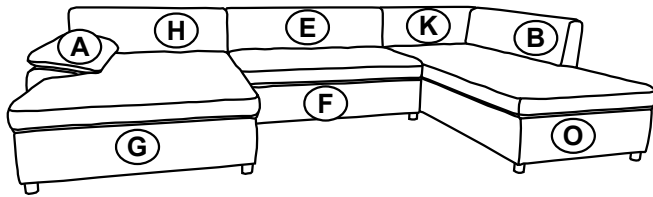

**R**

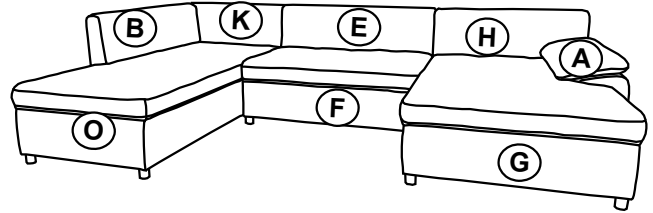

<b>a</b> 	<b>b</b> M8*80 	<b>c</b> M8 	<b>d</b> M10*30 	<b>e</b> M6*35 	<b>f</b> H-50 	<b>g</b> H-50 	<b>h</b> 5*50 	<b>i</b> 	<b>m</b> M8 
--------------	--------------------	-----------------	---------------------	--------------------	-------------------	-------------------	-------------------	--------------	-----------------

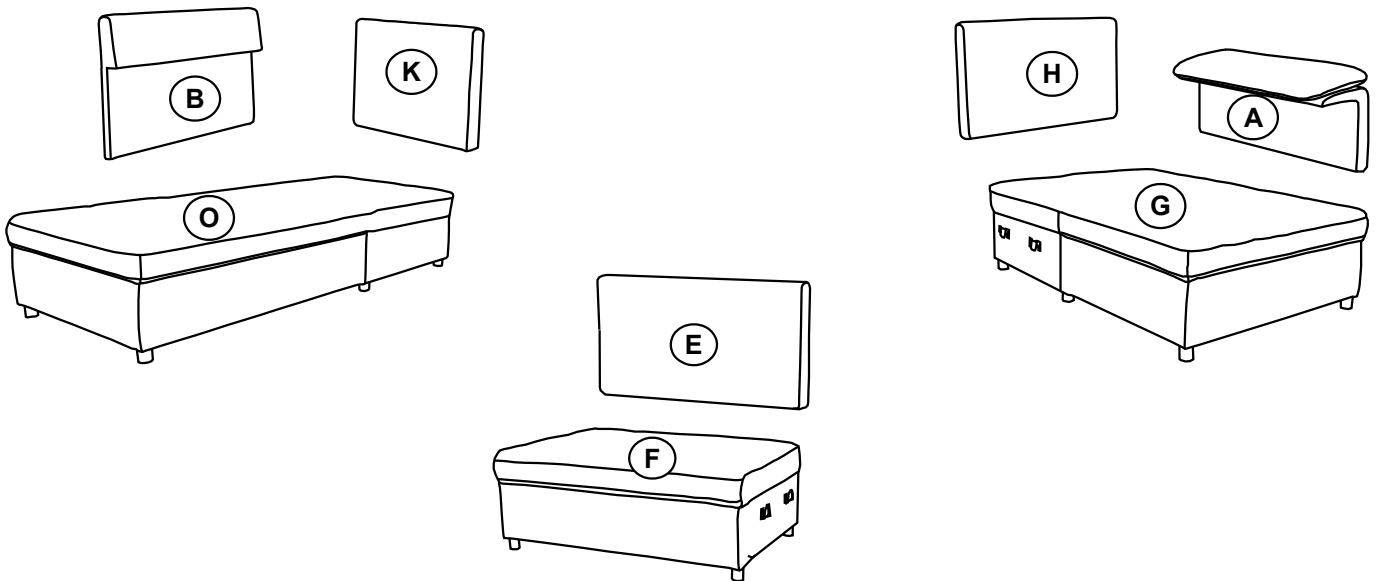

**L** X2

**M** X2

**S** X2

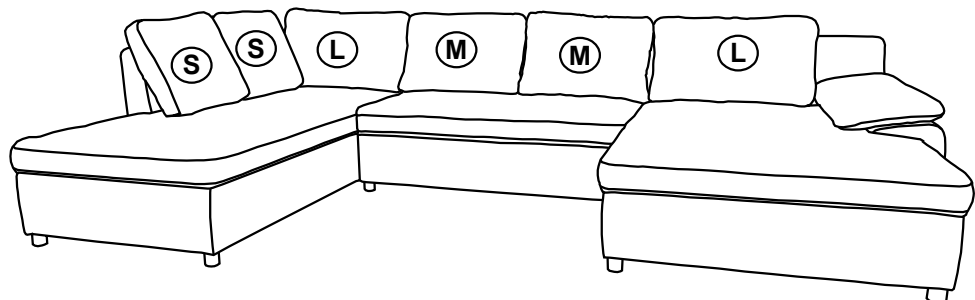

0  
10  
20  
30  
40  
50  
60  
70  
80  
90  
100  
110  
120  
130  
140  
150  
160  
170  
180  
190  
200