

**(D) Montageanleitung**

**(FR) Notice de montage**

**(NL) Handleiding voor de montage**

**(CZ) Montážní návod**

**(HU) Szerelési útmutató**

**(TR) Montaj talimatı**

**(GB) Assembly instructions**

**(IT) Istruzioni di montaggio**

**(PL) Instrukcja montażu**

**(SK) Návod na montáž**

**(RO) Instrucțiuni de montaj**

**(RU) Инструкция по монтажу**

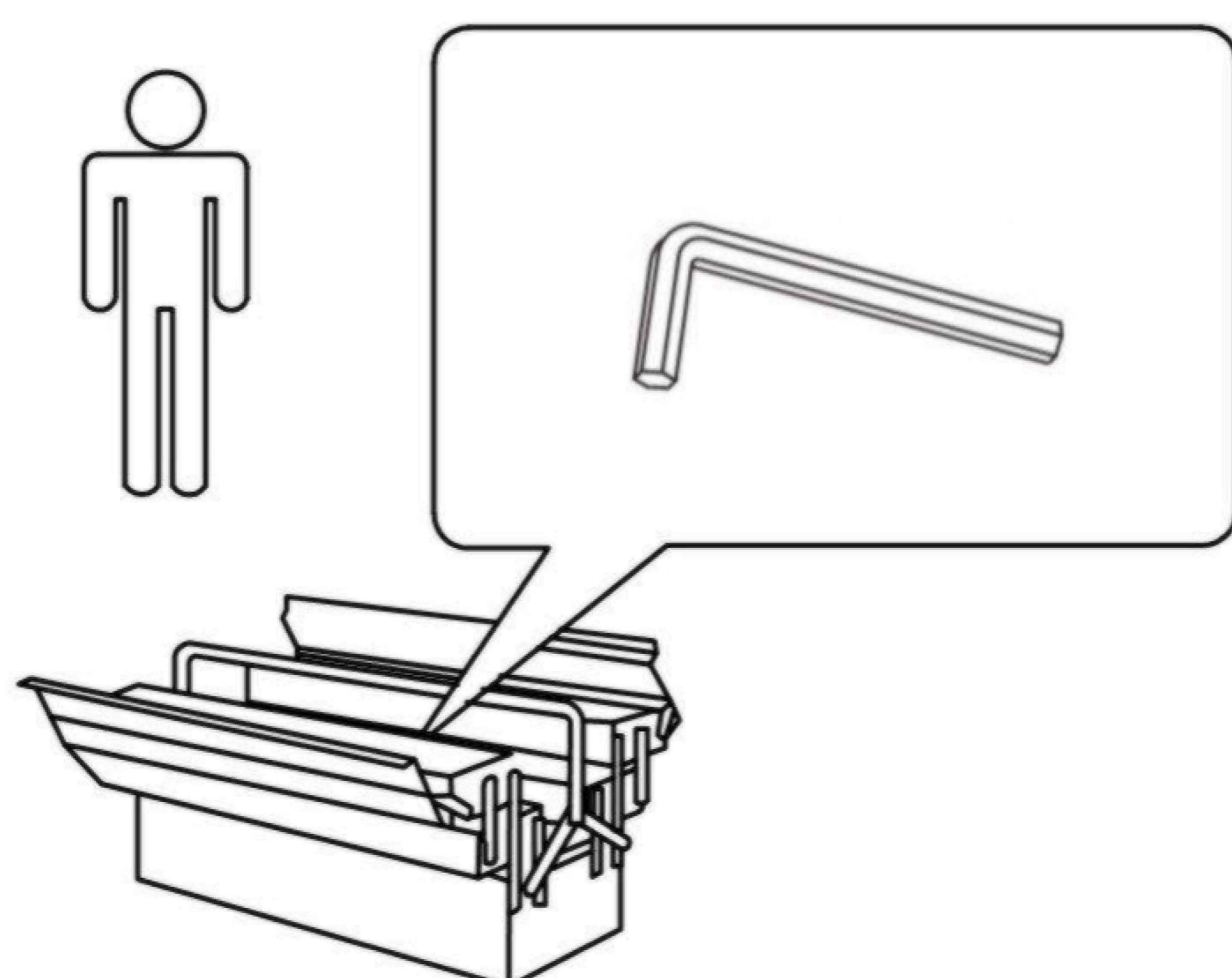
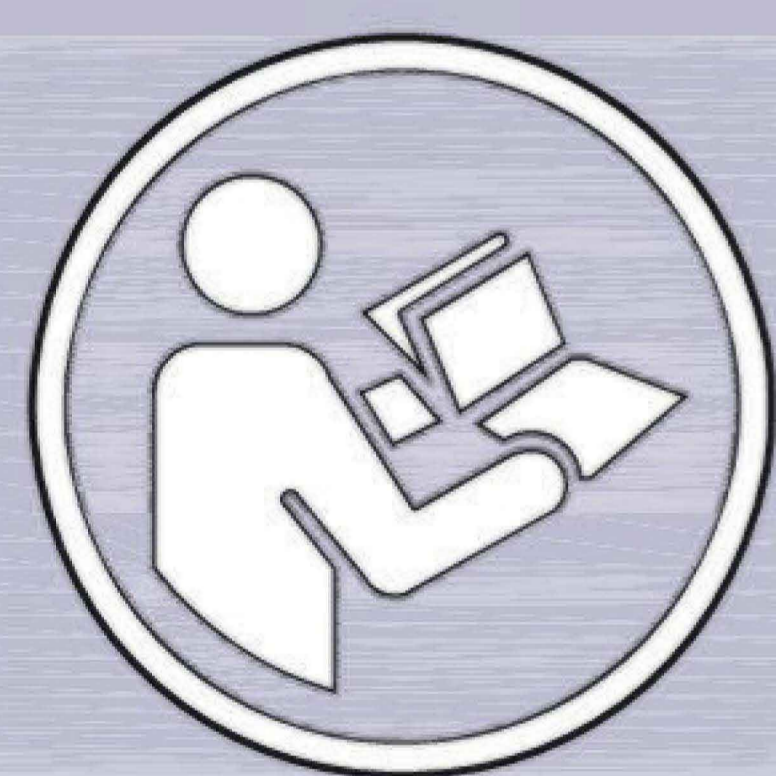

**Service • Assistenza • Dienstverlening • Serwis**  
**Servis • Szerviz • Сервисная служба**

Name • Nom • Nome • Naam Nazwa • Jméno • Názov • Név Denumire • Ísim • Название		
Nr. • No. • N° • Номер • Č • Sz	7137 7148 4033 3150 3153 8658 7365 6840 6287 2906	
Typ • Type • Tip • Típus • Tipo Тип		

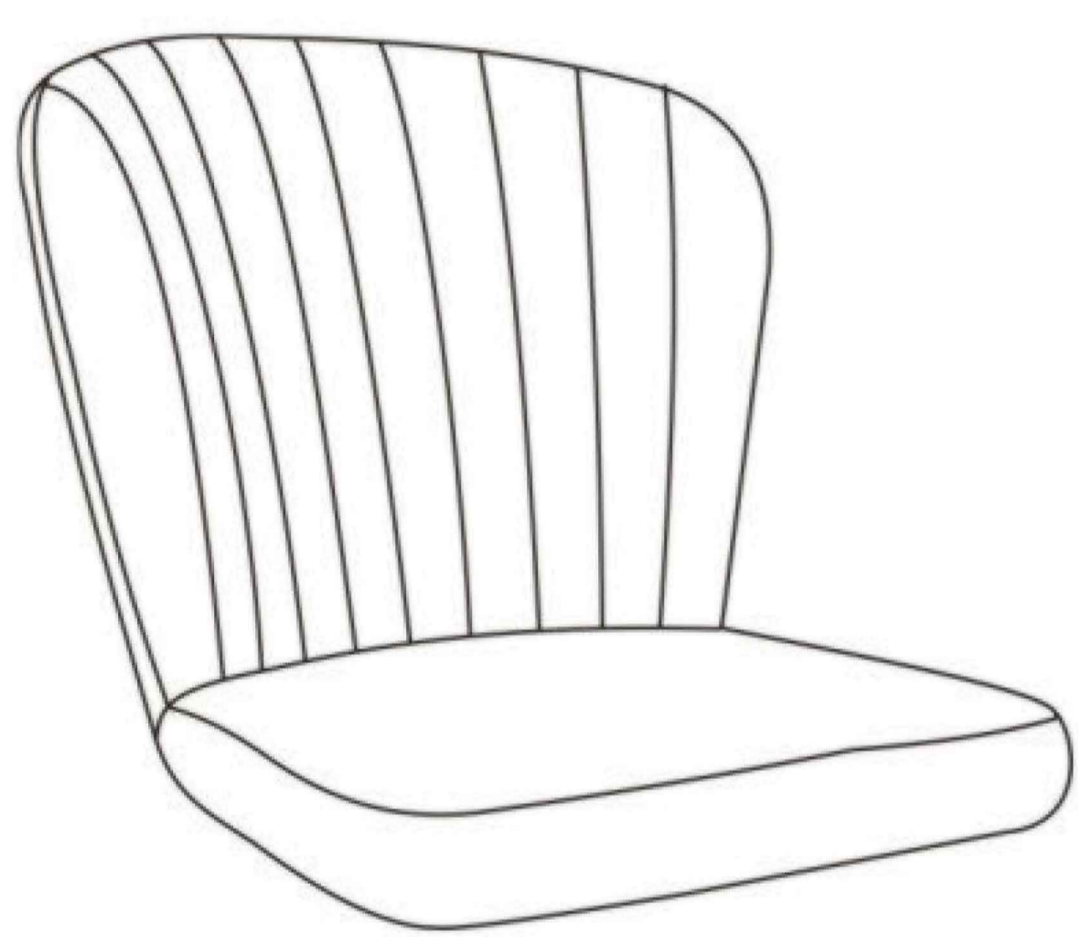

①1X



②1X

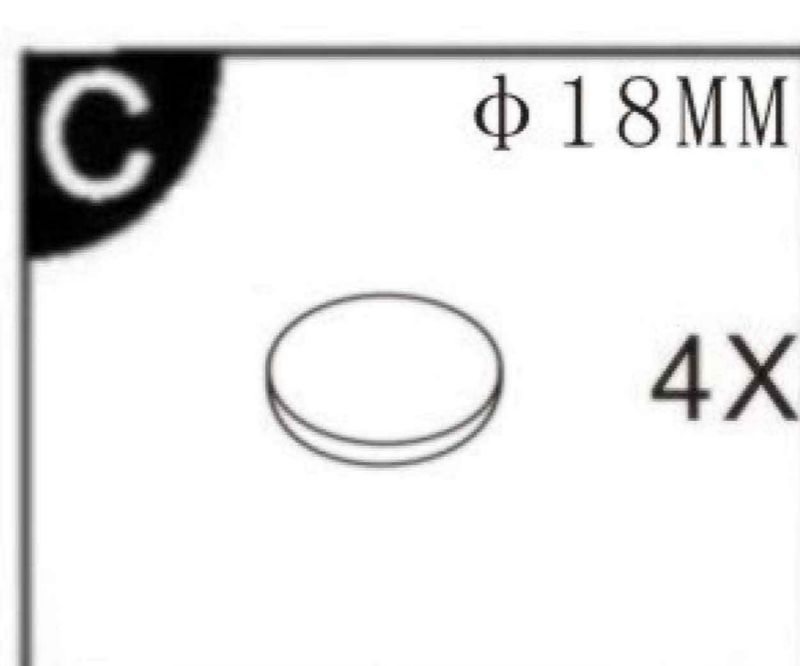
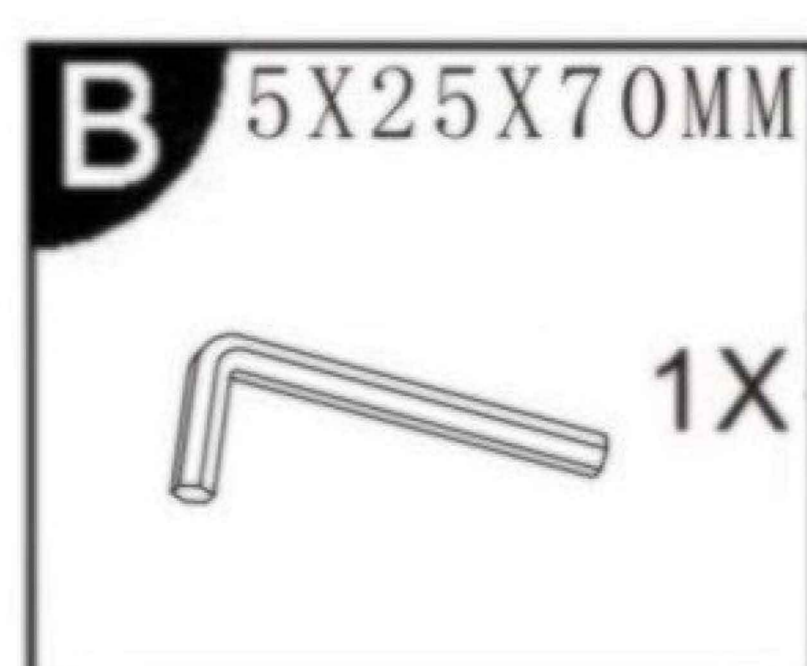
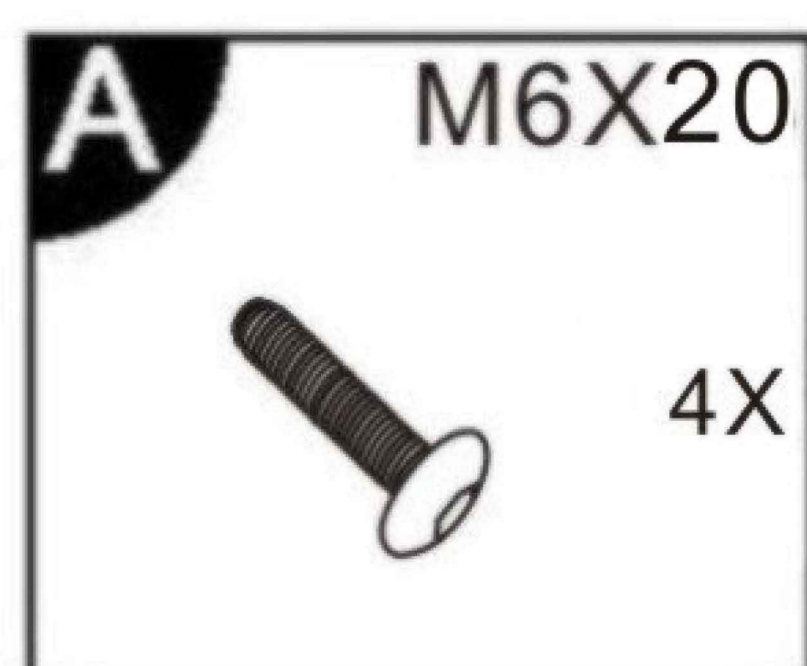

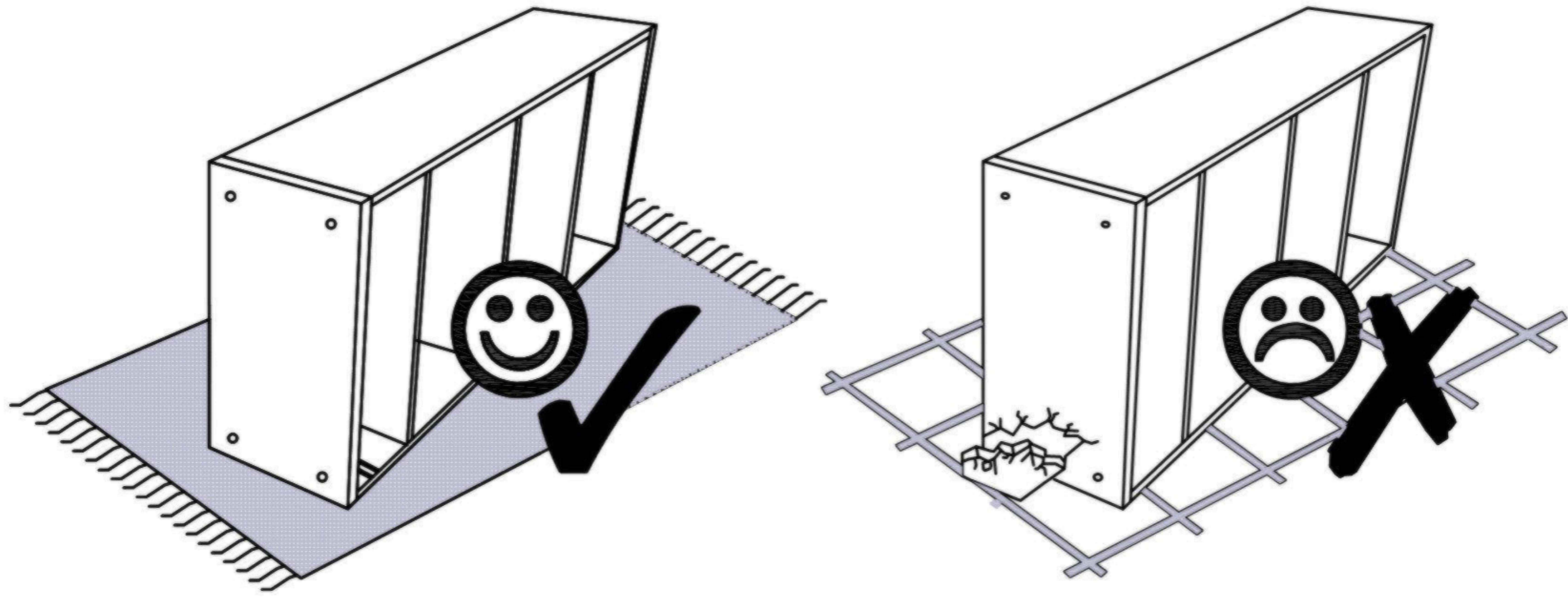

1

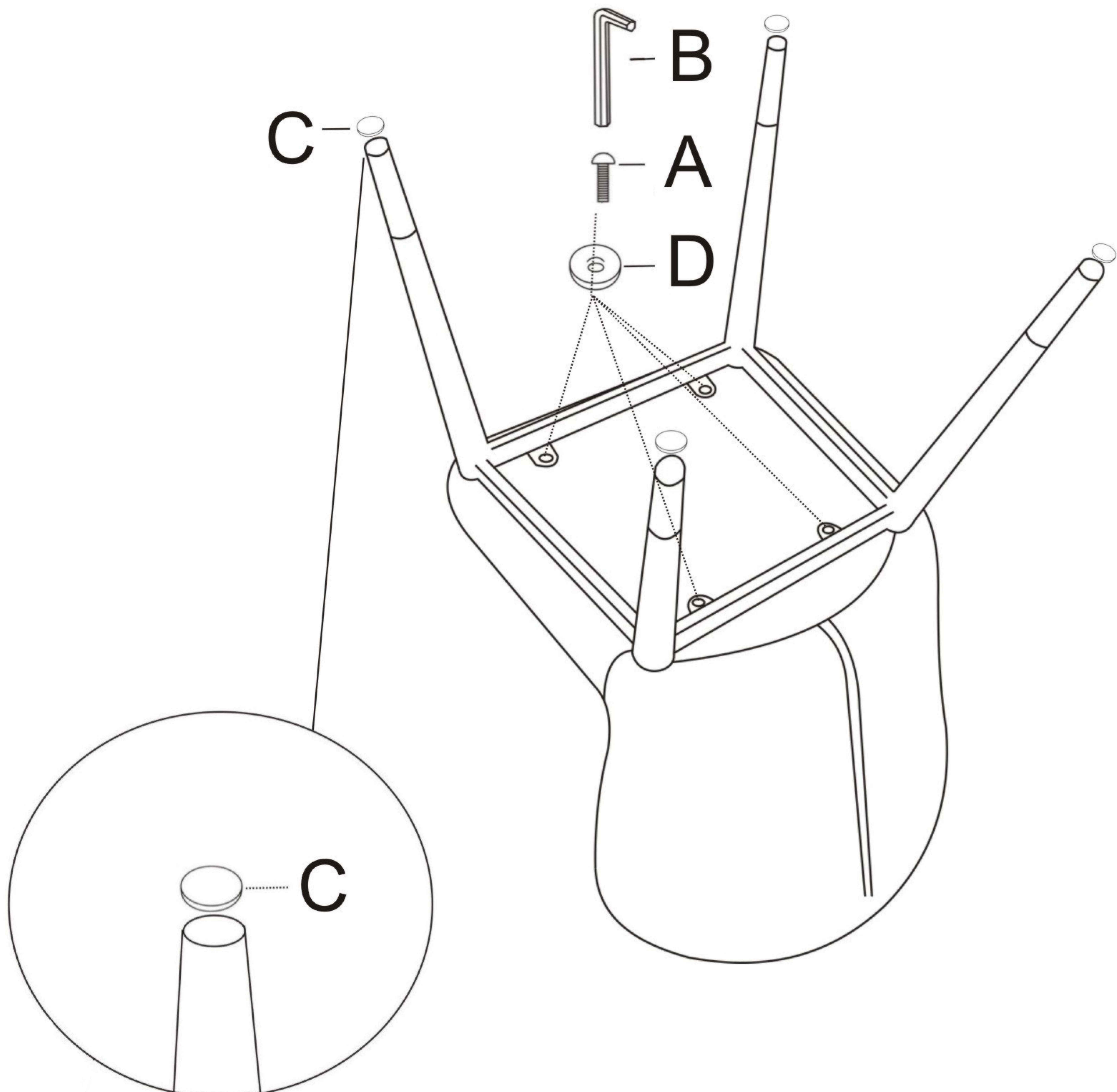

**A** M6X20  
4X

**B** 5X25X70MM  
1X

**C**  $\phi$  18MM  
4X

**D** 18X6X1.2MM  
4X

