

- | | |
|----------------------------------|------------------------------|
| (D) Montageanleitung | (FR) Notice de montage |
| (GB) Assembly instructions | (CZ) Montážní návod |
| (NL) Handleiding voor de montage | (TR) Montaj talimatı |
| (HU) Szerelési útmutató | (IT) Istruzioni di montaggio |
| (PL) Instrukcja montażu | (SK) Návod na montáž |
| (RO) Instrucțiuni de montaj | (RU) Инструкция по монтажу |

Service · Dienstverlening · Serwis · Servis · Сервисная служба

Name · Naam · Nazwa · isim · название

Nr. · No. · Nazwa · isim · номер

Typ · Type · Tip · тип

Farbe · colour · Renk · Kleur · Kolor · Цвет

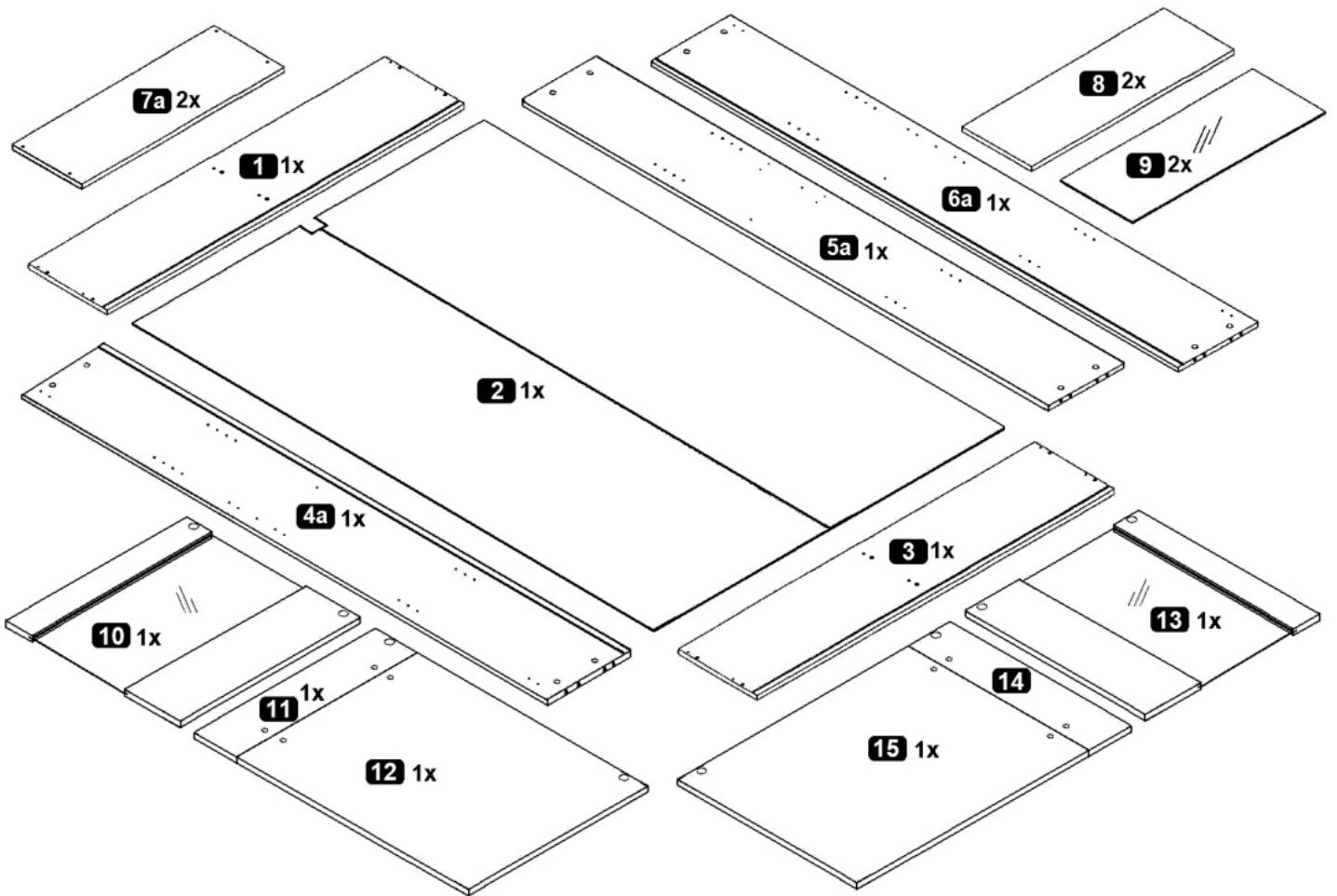
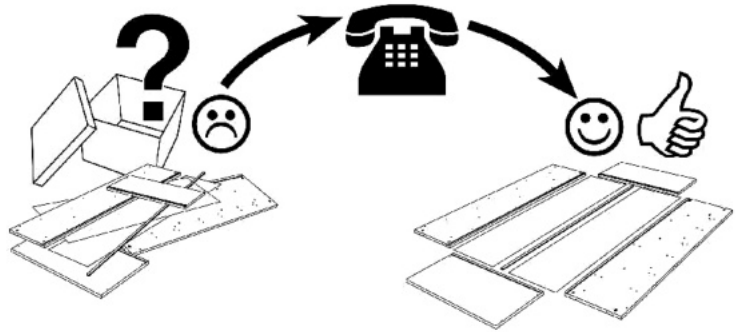
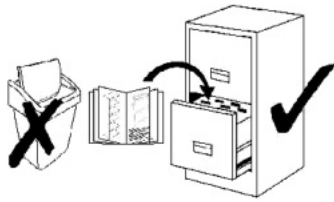

1	1x	ca. 1060 x 300 mm
2	1x	ca. 1212 x 1041 mm
3	1x	ca. 1060 x 300 mm
4a	1x	ca. 1200 x 280 mm
5a	1x	ca. 1200 x 260 mm

6a	1x	ca. 1200 x 280 mm
7a	2x	ca. 507 x 260 mm
8	2x	ca. 507 x 240 mm
9	2x	ca. 507 x 240 mm
10	1x	ca. 528 x 528 mm

11	1x	ca. 528 x 100 mm
12	1x	ca. 528 x 562 mm
13	1x	ca. 528 x 528 mm
14	1x	ca. 528 x 100 mm
15	1x	ca. 528 x 562 mm

A	8,0 x 30 mm	B	12x	C	20x	D	3,9x9,5mm	E	60 mm	F	h=2	G	Ø26 Kr.0
H	16x	I	2,7 x 20 mm	J	5x	K	4,0 x 20 mm	L	5x	M	8x		



1

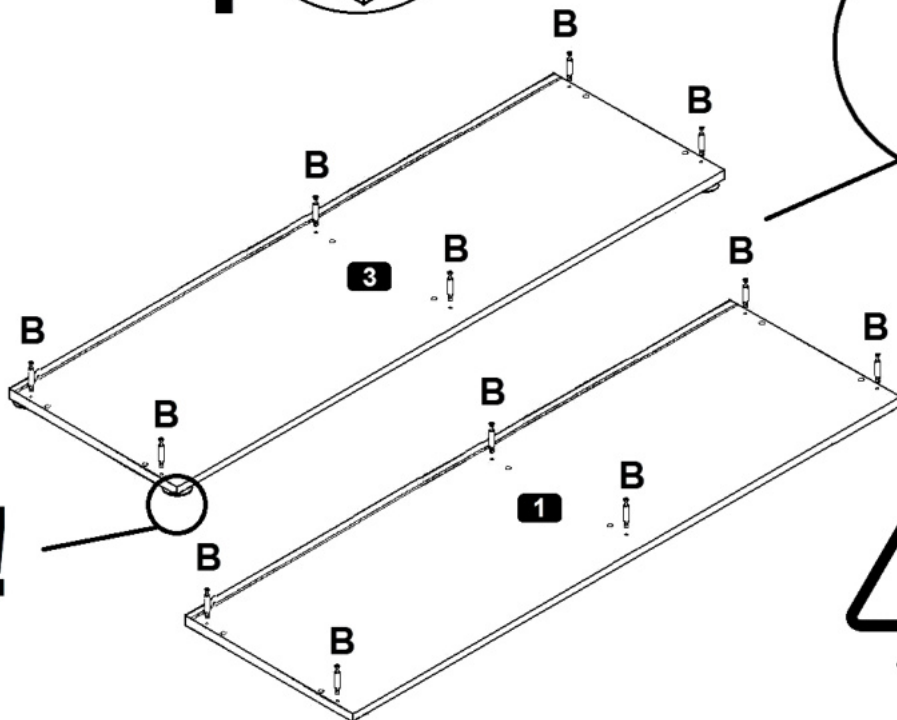
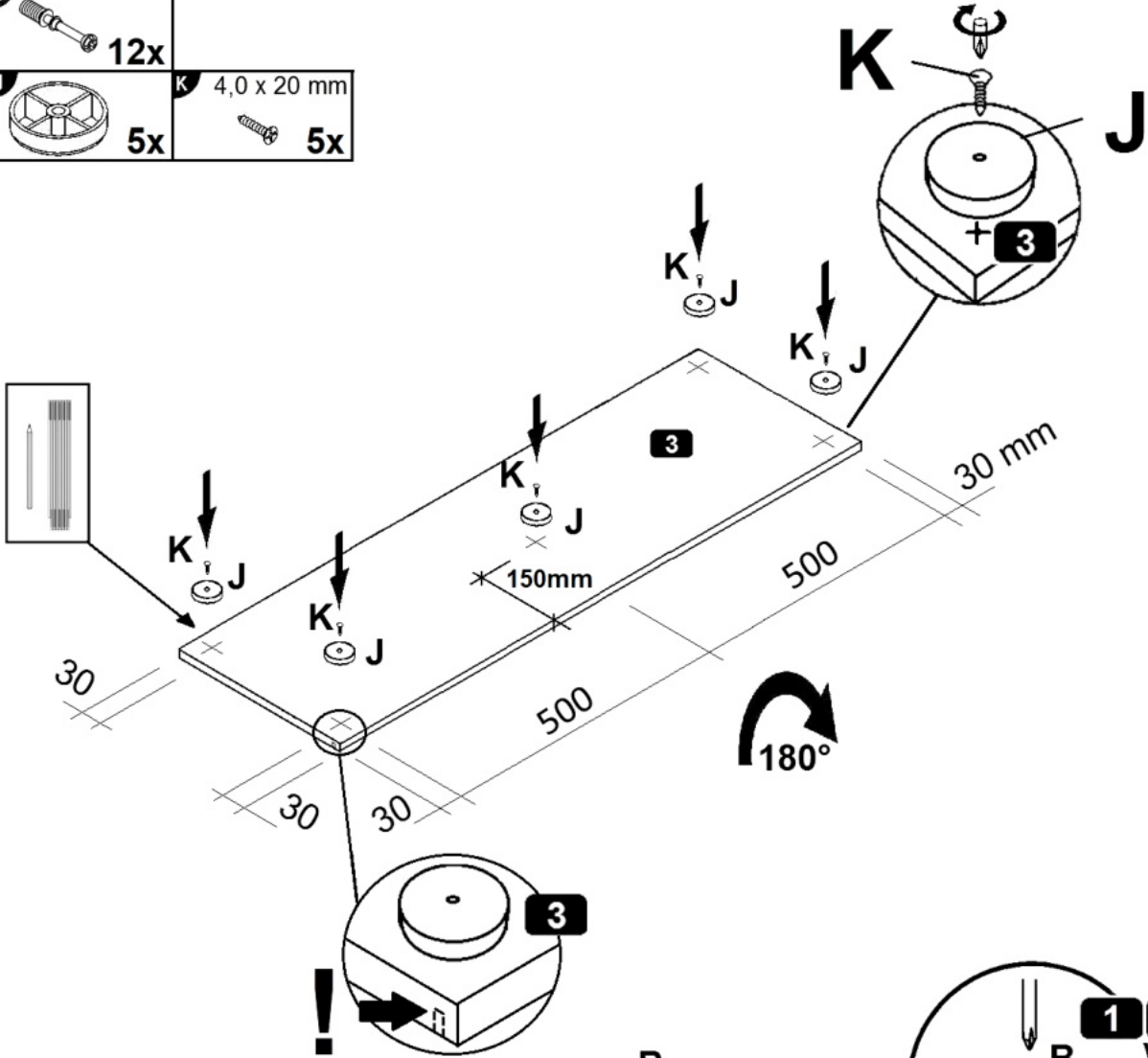
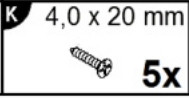
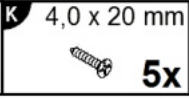
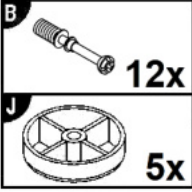
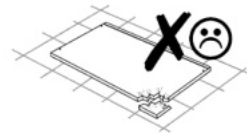
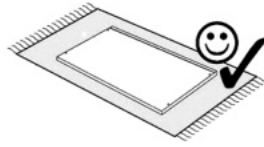
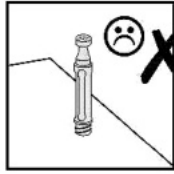
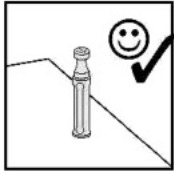



MA3

2

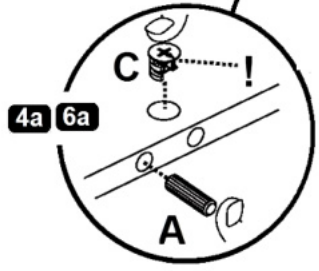
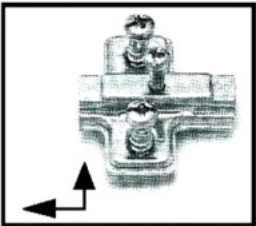
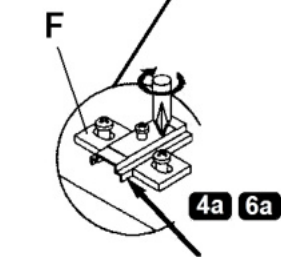
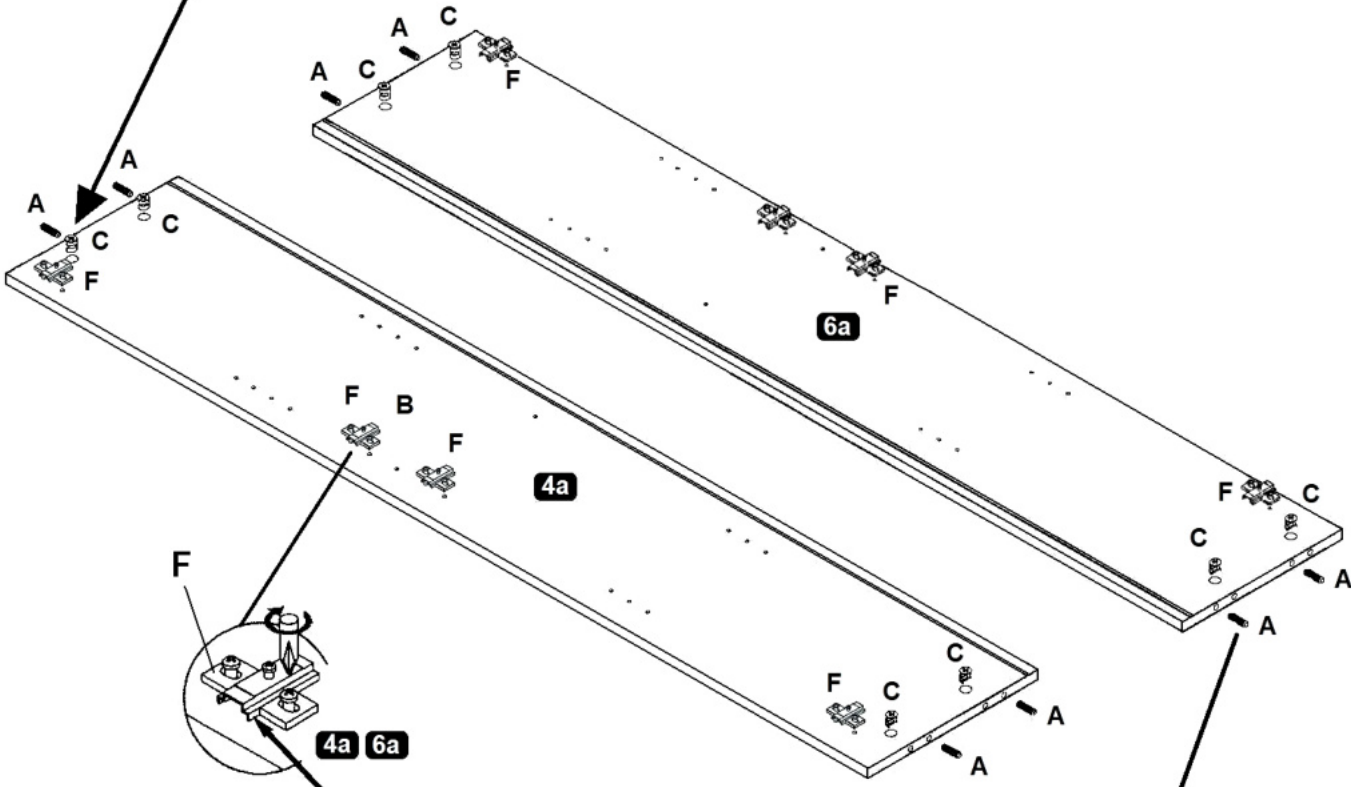
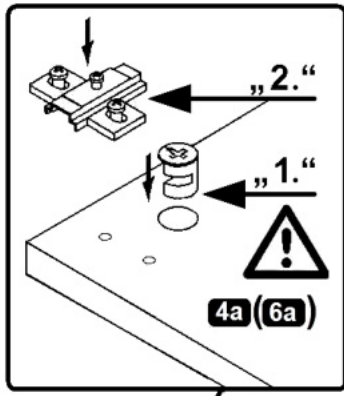
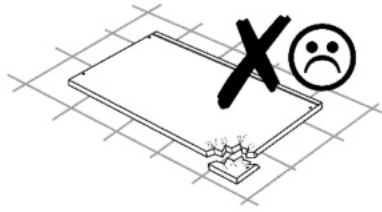
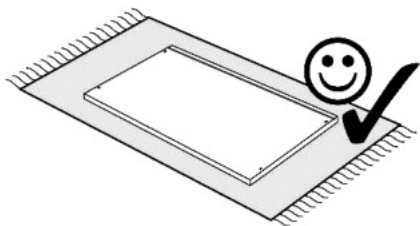
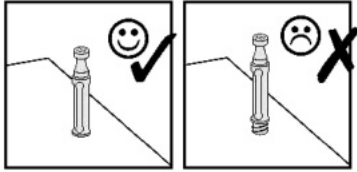
- A** 8,0 x 30 mm **8x**
- C**  **8x**
- F**  h = 2 **8x**



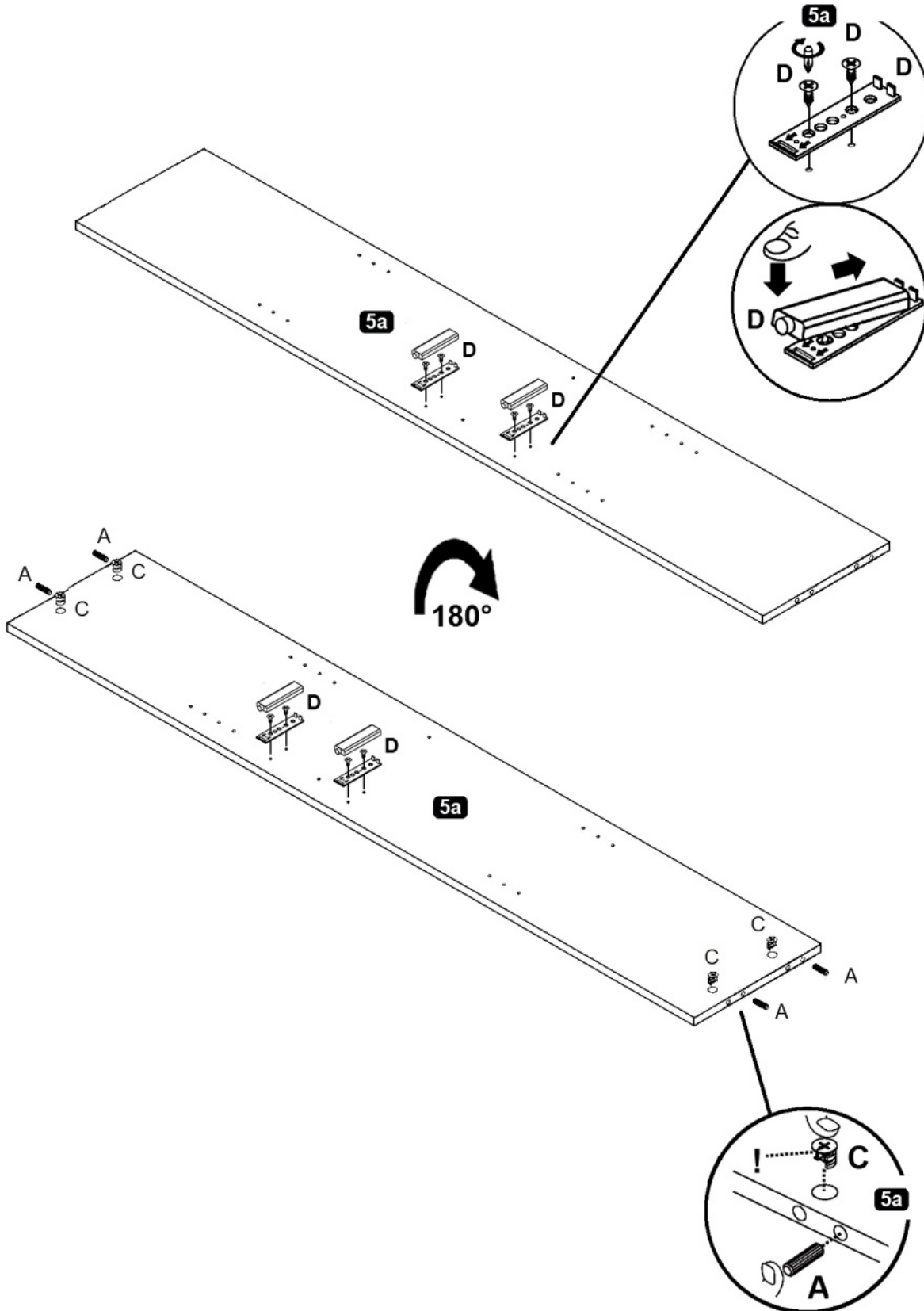
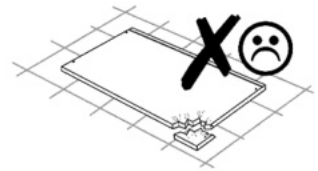
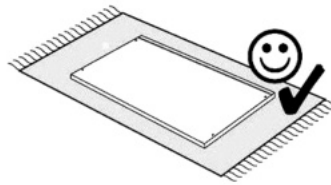

3

A 8,0 x 30 mm  4x	C  4x	D 3,9x9,5mm  4x
---	---	---



4

H		16x
L		2,7 x 20 mm 8x
M		8x

3. ↓

4.

7. H

M



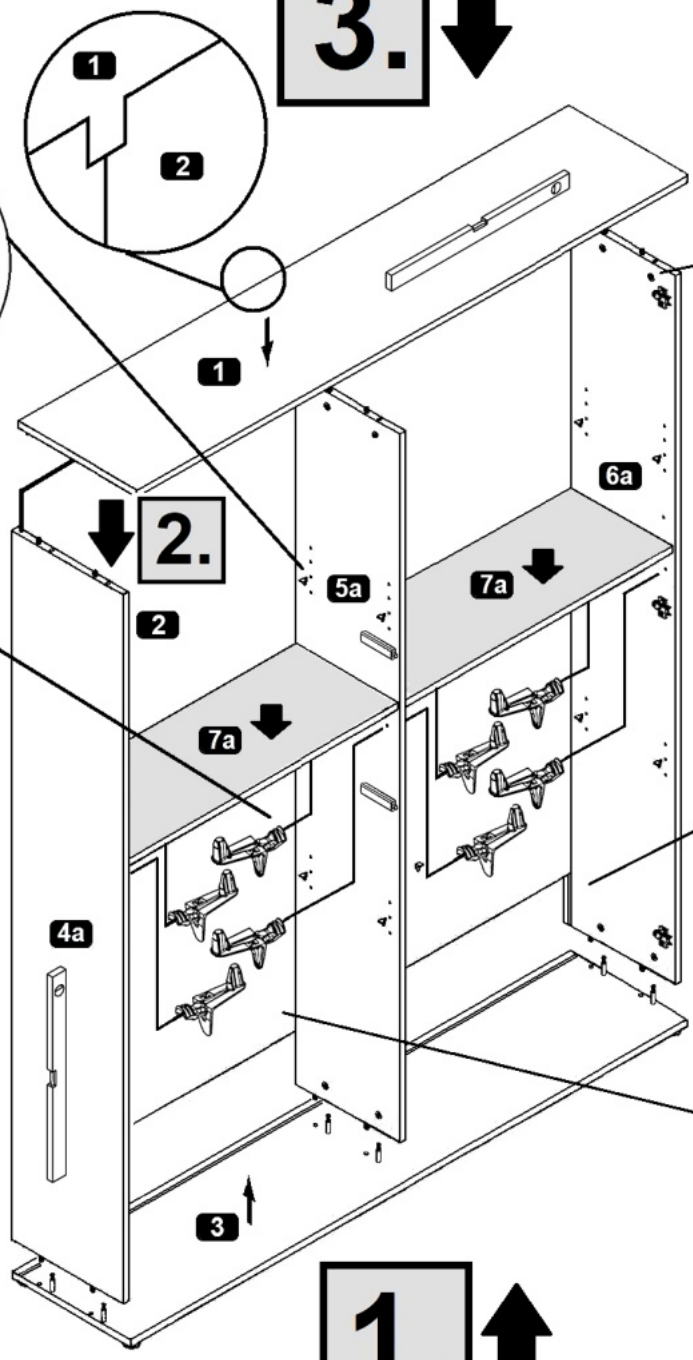
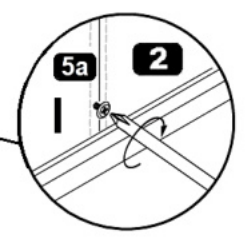
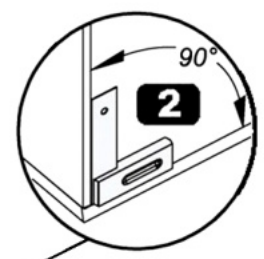
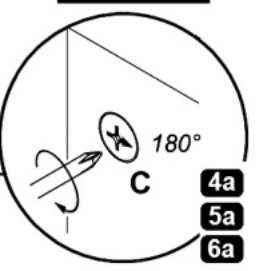

6.

M

1. ↑

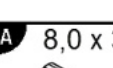

5

G		Ø26 Kr.0	8x
E		60 mm	4x
A		8,0 x 30 mm	4x
C			8x

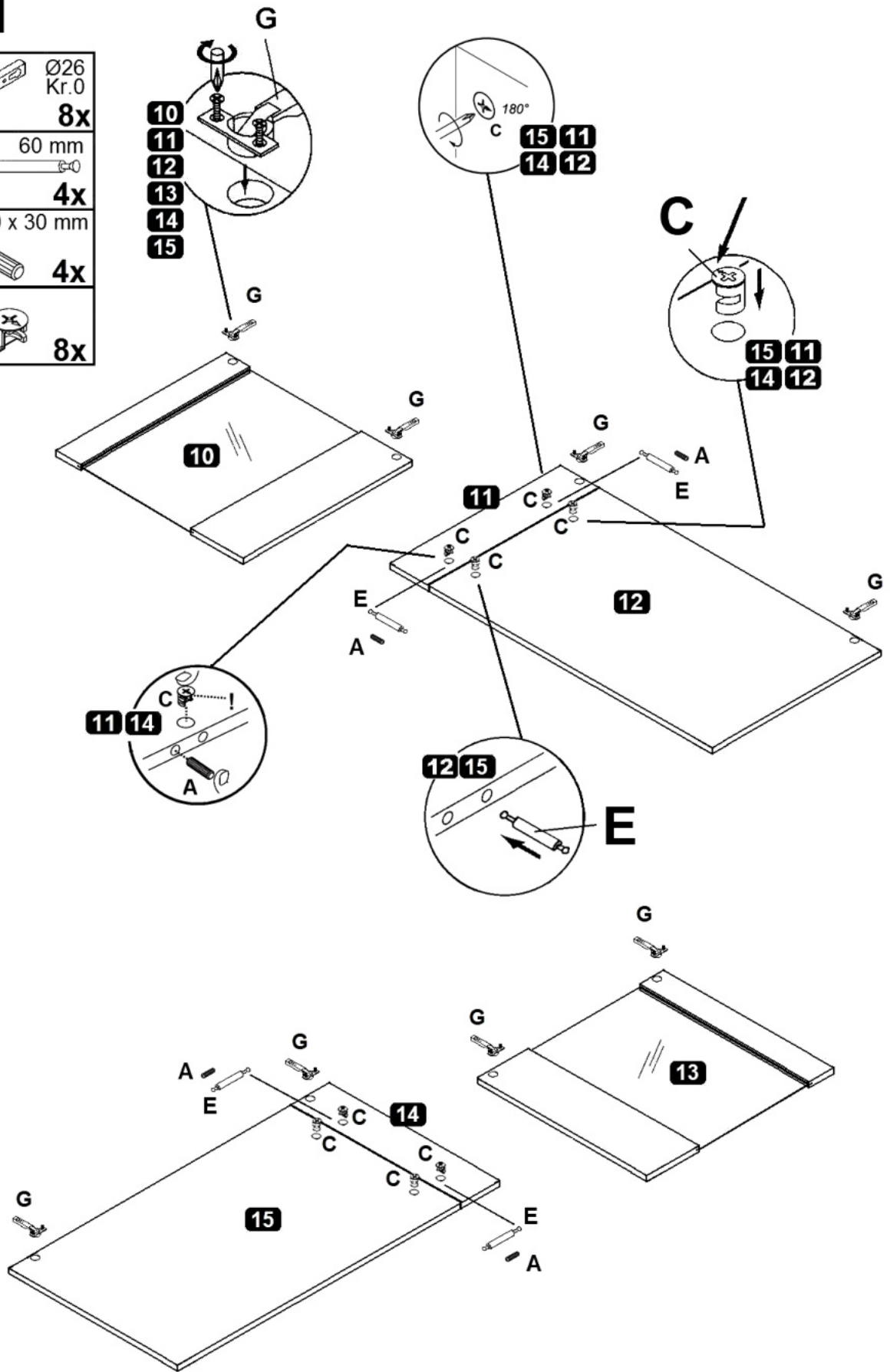

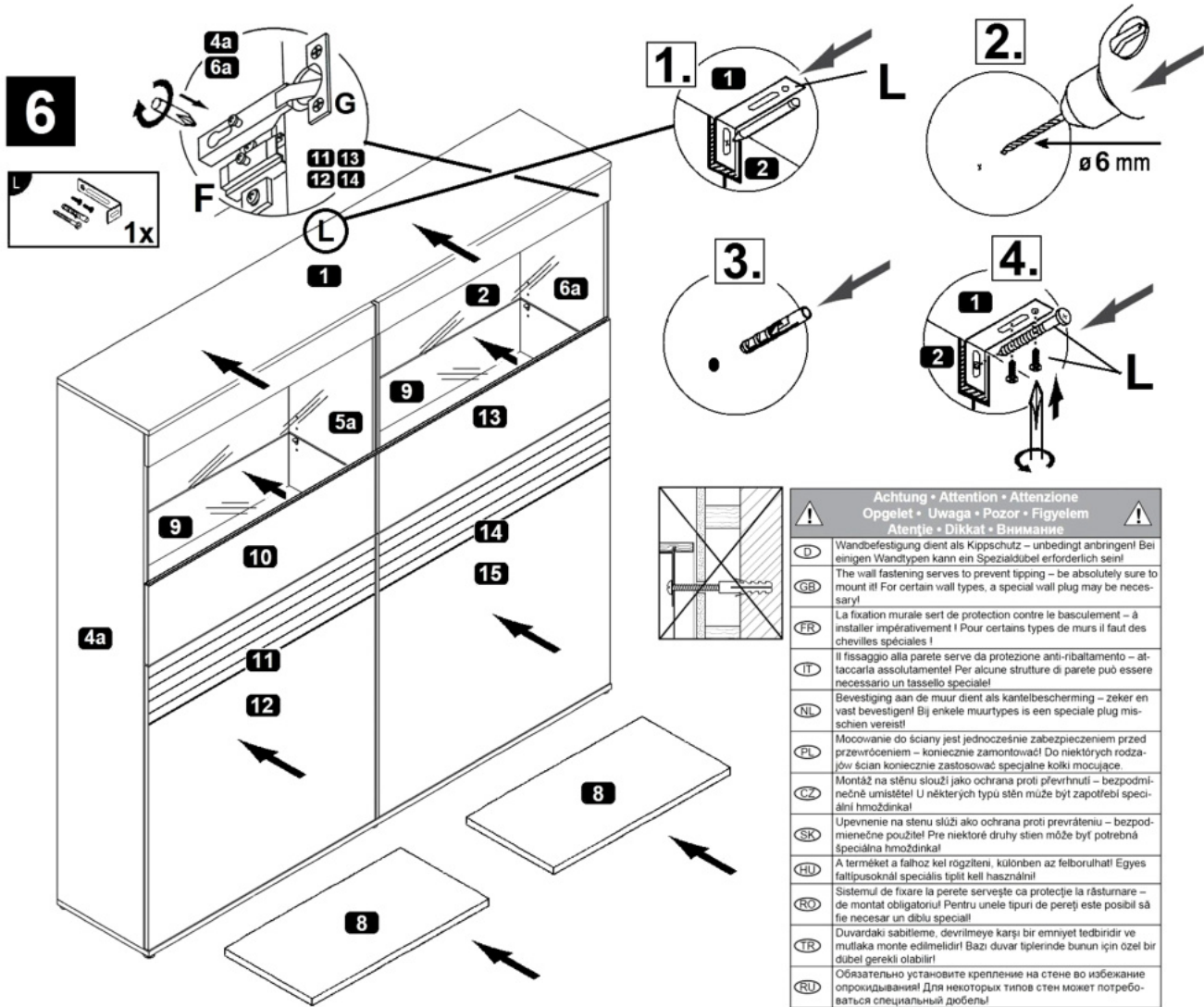

➔ 9 / 10

(D) Push-To-Open einstellen
 (GB) Adjusting the Push-To-Open
 (FR) Régler les Push-To-Open
 (IT) Sistemare Push-To-Open
 (NL) Push-To-Open instellen
 (PL) Nastawić Push-To-Open
 (CZ) Vyrovnajte Push-To-Open
 (RO) Nastavenie Push-To-Open
 (HU) Állítsa be az Push-To-Open
 (SK) Reglare Push-To-Open
 (TR) Push-To-Open ayarlanması
 (RU) Регулировка Push-To-Open

➔ 10 / 10

(D) Türen einstellen
(Scharniere justieren)
 (GB) Adjusting the doors
(adjusting the hinges)
 (FR) Régler les portes
(ajuster les charnières)
 (IT) Sistemare le porte
(regolare le cerniere)
 (NL) Deuren instellen
(scharnieren afstellen)
 (PL) Nastawić drzwi
(wyregulować zawiasy)
 (CZ) Vyrovnajte dvířka
(seřid'te závěsy)
 (RO) Nastavenie dverí
(nastavenie závesov)
 (HU) Állítsa be az ajtókat
(állítsa be a zsanérokat)
 (SK) Reglare uși
(ajustare balamale)
 (TR) Kapıların ayarlanması
(menteşelerin seviye ayarı)
 (RU) Регулировка дверей
(регулировка шарнира)

7

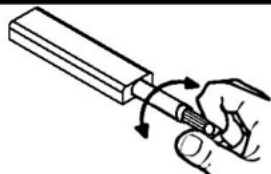

- | | |
|--|--|
| (D) Push-To-Open einstellen | (CZ) Vyrovnejte Push-To-Open |
| (GB) Adjusting the Push-To-Open | (RO) Nastavenie Push-To-Open |
| (FR) Régler les Push-To-Open | (HU) Állítsa be az Push-To-Open |
| (IT) Sistemare Push-To-Open | (SK) Reglare Push-To-Open |
| (NL) Push-To-Open instellen | (TR) Push-To-Open ayarlanması |
| (PL) Nastawić Push-To-Open | (RU) Регулировка Push-To-Open |

1.

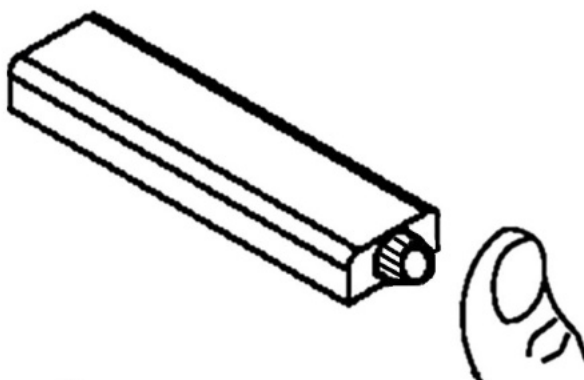

2.

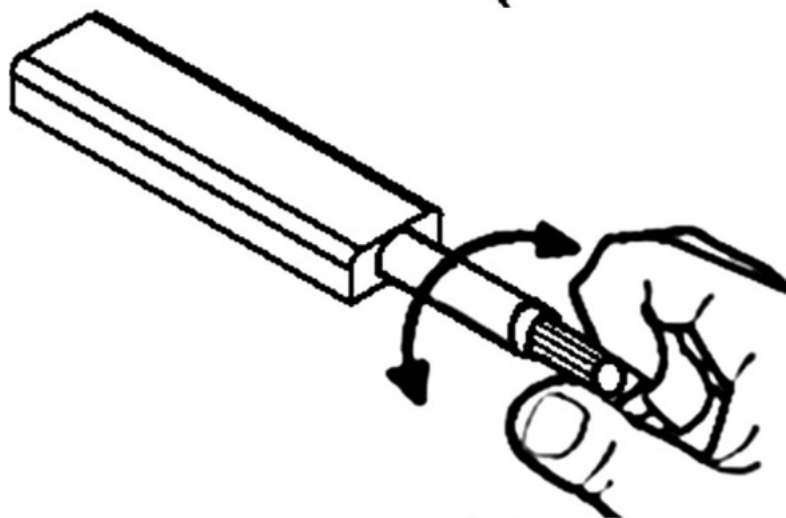

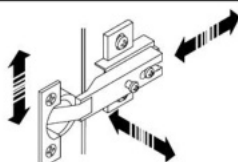

(D) **Türen einstellen**
(Scharniere justieren)

(GB) **Adjusting the doors**
(adjusting the hinges)

(FR) **Régler les portes**
(ajuster les charnières)

(IT) **Sistemare le porte**
(regolare le cerniere)

(NL) **Deuren instellen**
(scharnieren afstellen)

(PL) **Nastawić drzwi**
(wyregulować zawiasy)

(CZ) **Vyrovnejte dvířka**
(seřid'te závěsy)

(RO) **Nastavenie dverí**
(nastavenie závesov)

(HU) **Állítsa be az ajtókat**
(állítsa be a zsanérokat)

(SK) **Reglare uši**
(ajustare balamale)

(TR) **Kapıların ayarlanması**
(menteşelerin seviye ayarı)

(RU) **Регулировка дверей**
(регулировка шарнира)

