

(D) Montageanleitung

(GB) Assembly instructions

(RO) Instrucțiuni de montaj

(FR) Notice de montage

(IT) Istruzioni di montaggio

(RU) Инструкция по монтажу

(NL) Handleiding voor de montage

(HU) Szerelési útmutató

(PL) Instrukcja montażu

(CZ) Montážní návod

(TR) Montaj talimatı

(SK) Návod na montáž



Lago / Lago 2 A



10

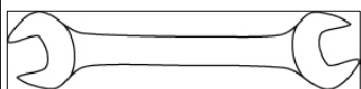

13

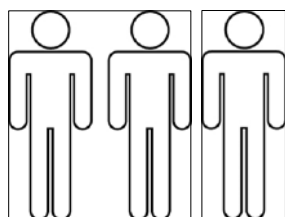
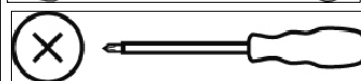

03.01.2012

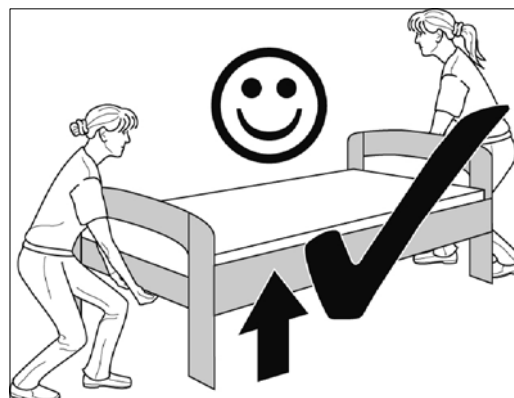

SK LAGO LR ZER Komfort EB

Service • Assistenza • Dienstverlening • Serwis Servis • Szerviz • Сервисная служба

Name • Nom • Nome • Naam
Nazwa • Jméno • Názov • Név
Denimire • Ísim • Название

SKLR-ZER-
Komfort-EB

Nr. • No. • N° • Номер • Č • Sz

Typ • Type • Tip • Típus • Тиро
Тип

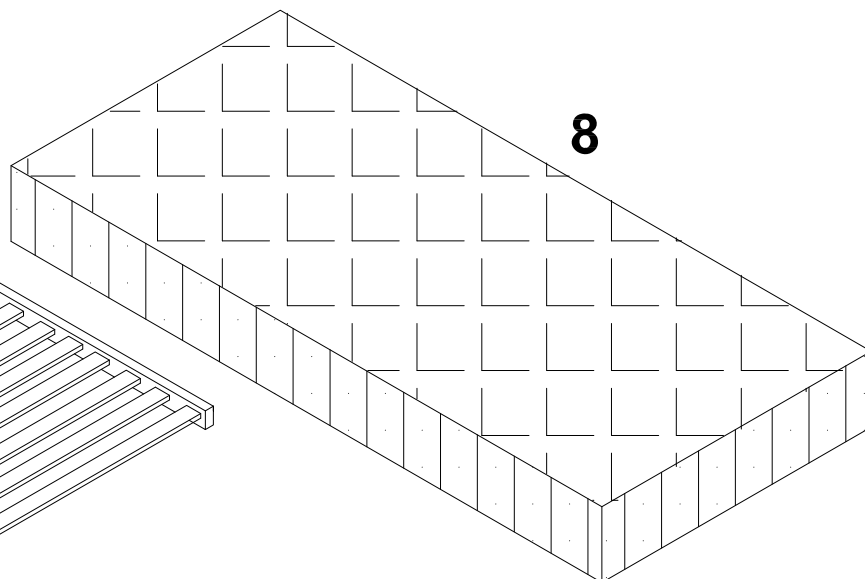
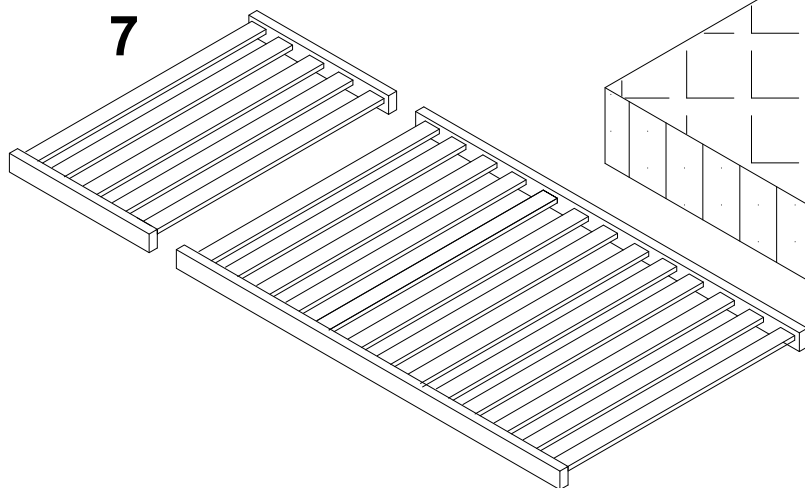
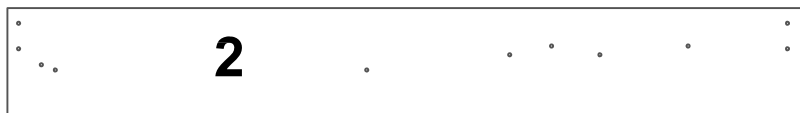
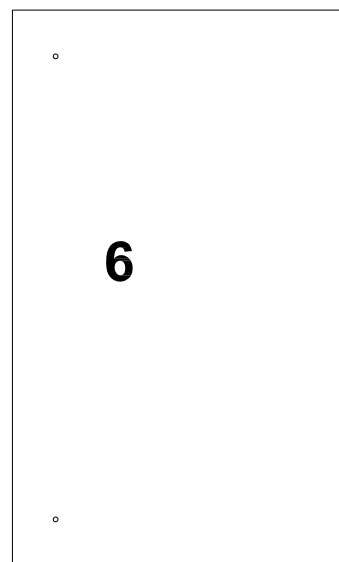
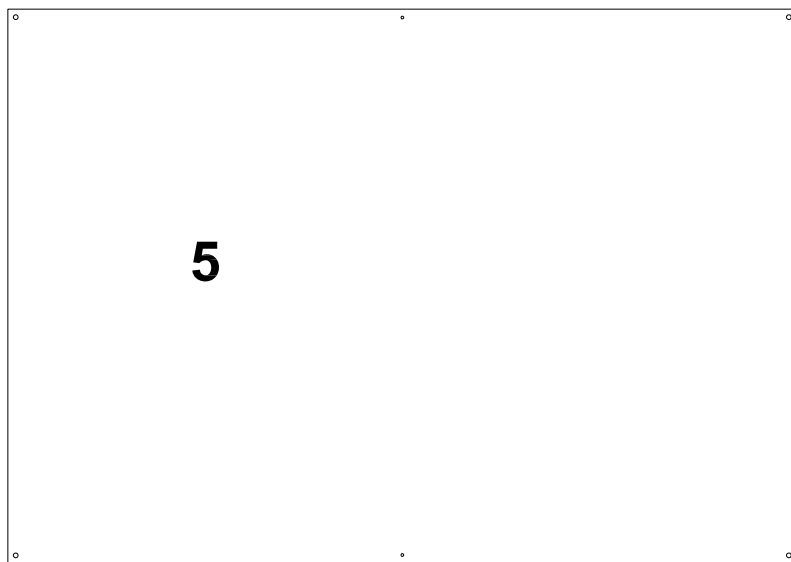
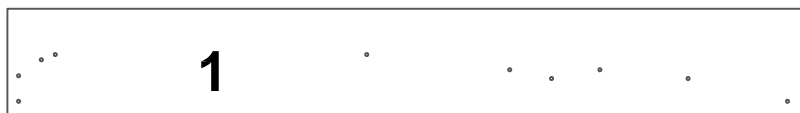
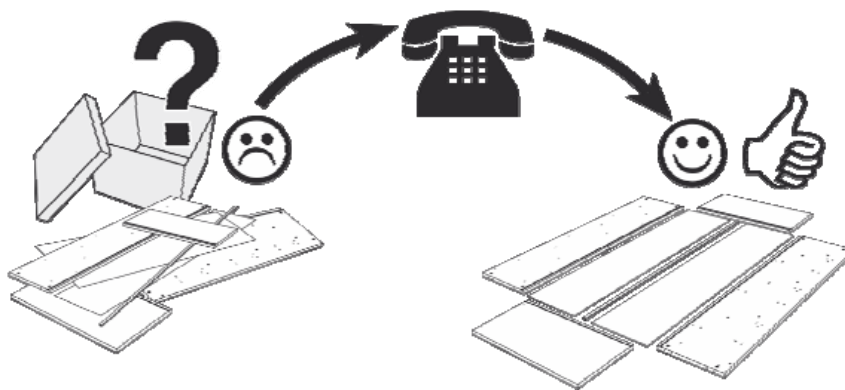
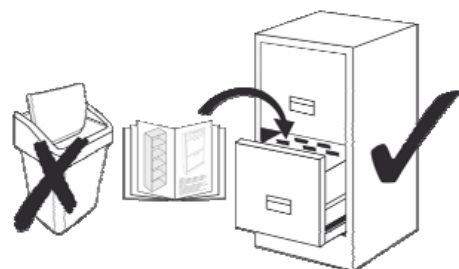

Service • Assistenza • Dienstverlening • Serwis Servis • Szerviz • Сервисная служба

Name • Nom • Nome • Naam
Nazwa • Jméno • Názov • Név
Denumire • Ísim • Название

SKLR-
ZER-EB

Nr. • No. • N° • Номер • Č • Sz

Typ • Type • Tip • Típus • Tipo
Тип - 0-

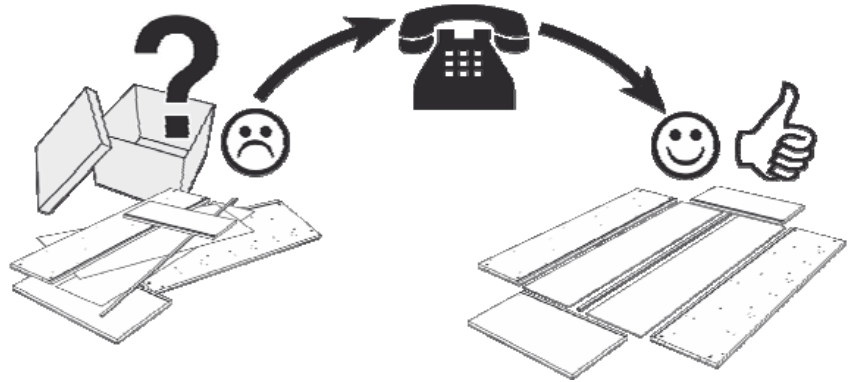
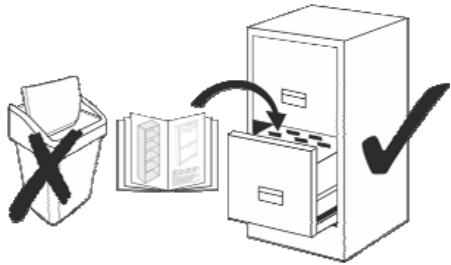

Fu1

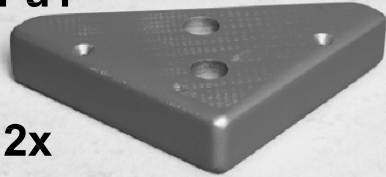

2x

Fu2



2x

Wi



2x

BVR



1x

BVL



1x

LRF



2x

EW

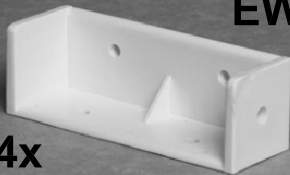

4x

DR



2x

FS

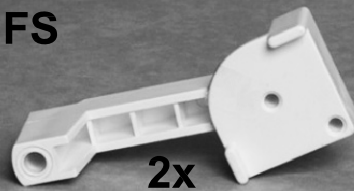

2x

A x20	B x2	C x2	D x2	E x2	F 2/x2	G x2	H 3/x2	J x2	K 2/x2	J x2	
M6x20	M6x35	M6x45	4,5x45	M8x45	M8	M6x35	M6	M5x16	M5	4,5x16	

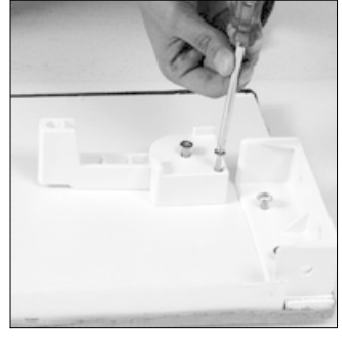
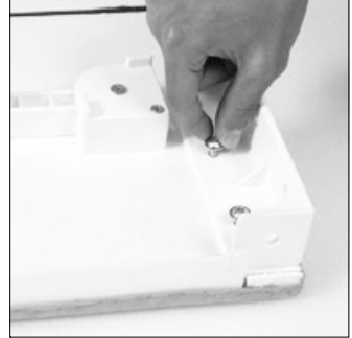
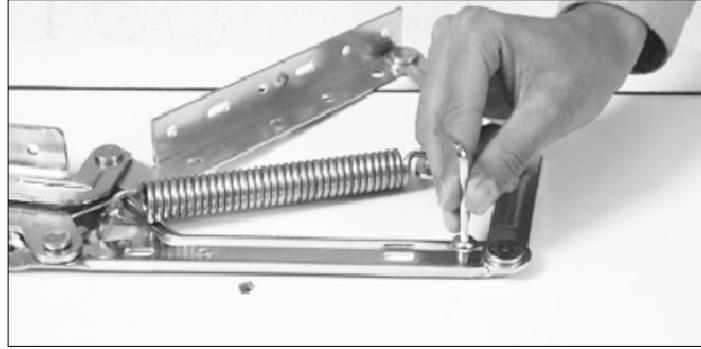
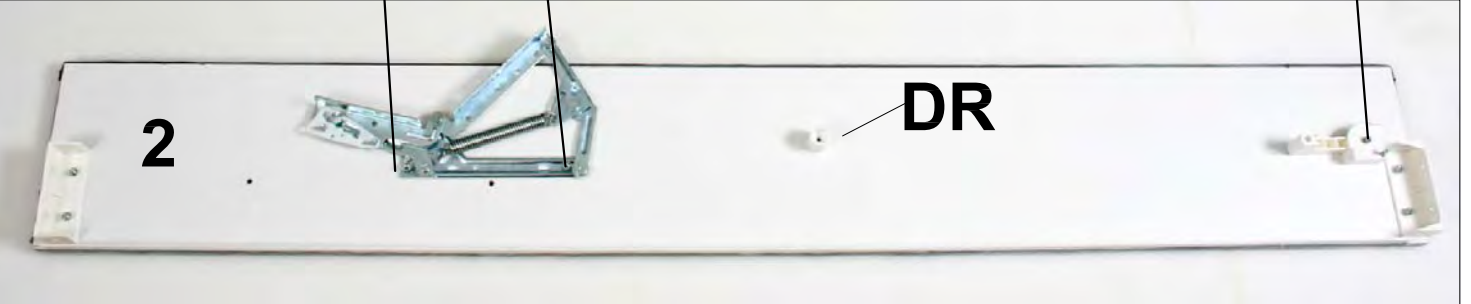
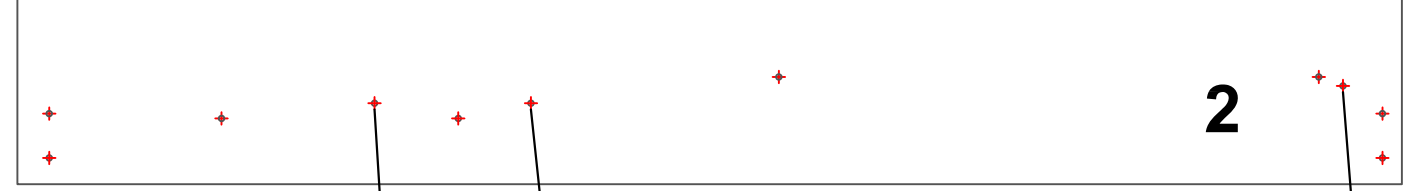
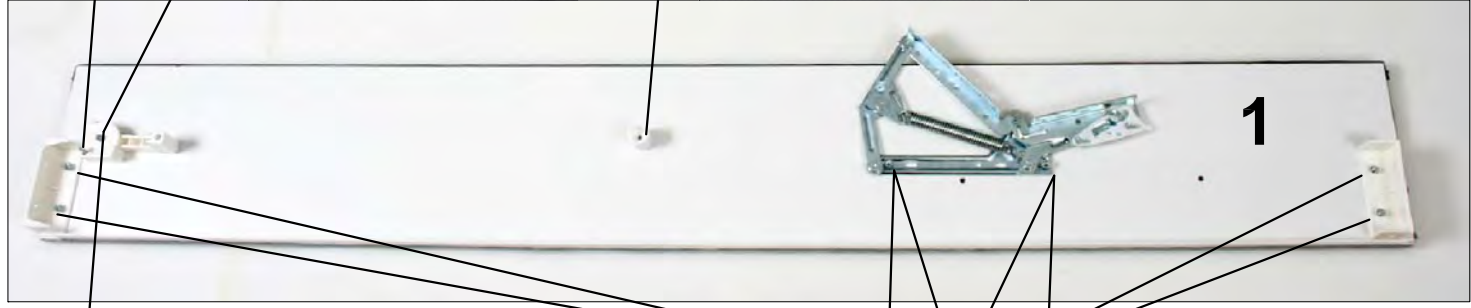
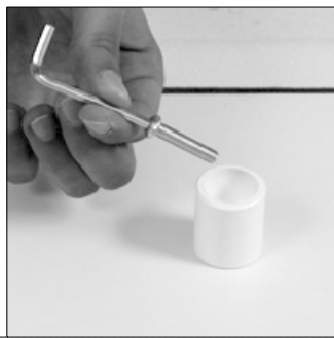
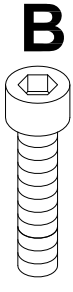
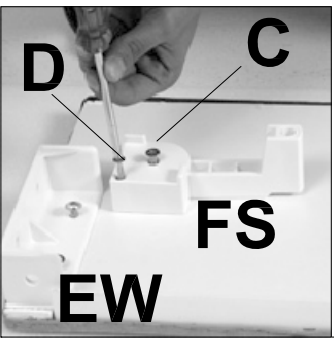
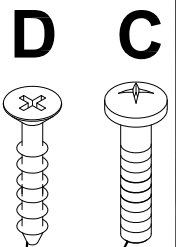

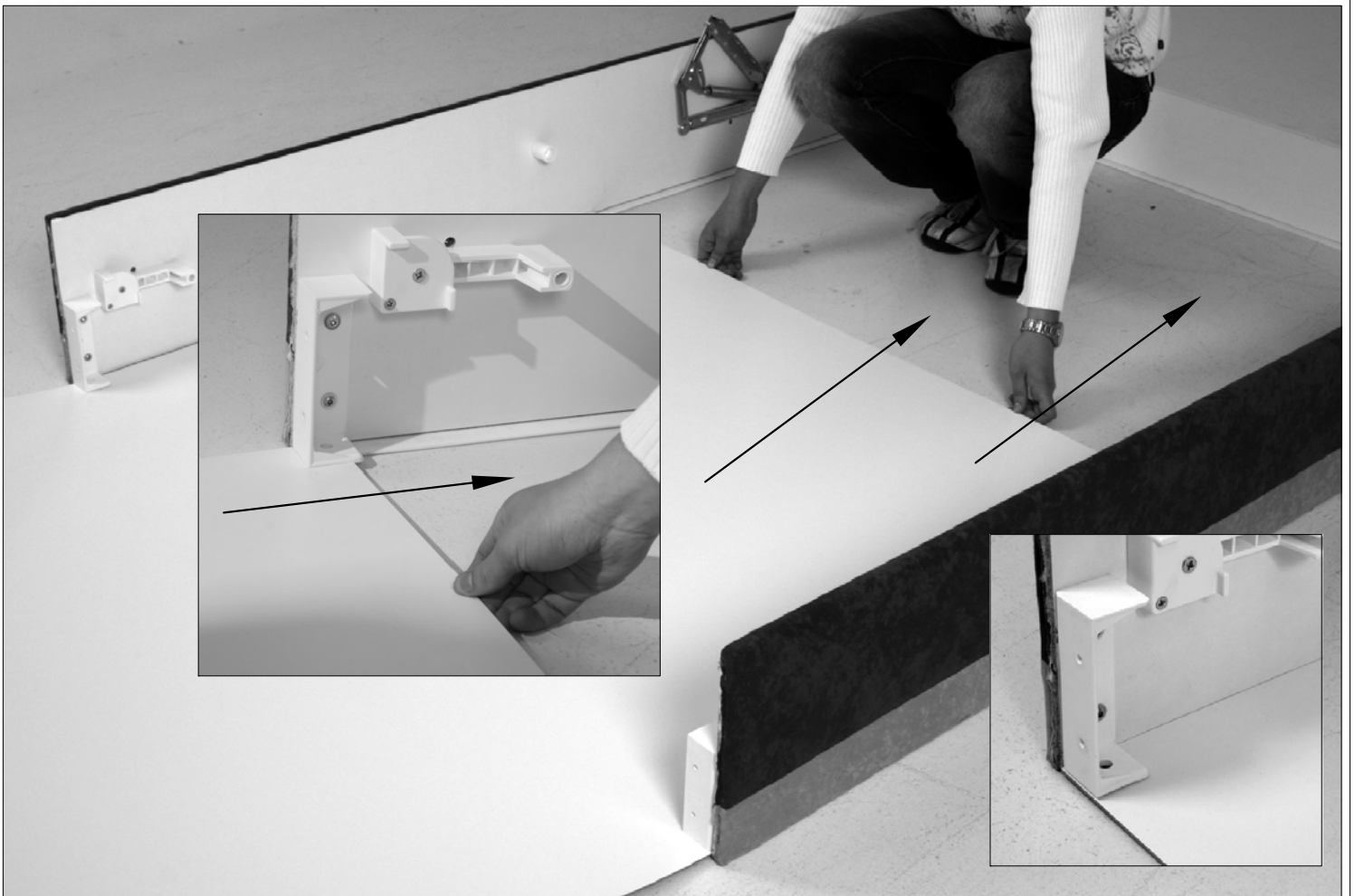
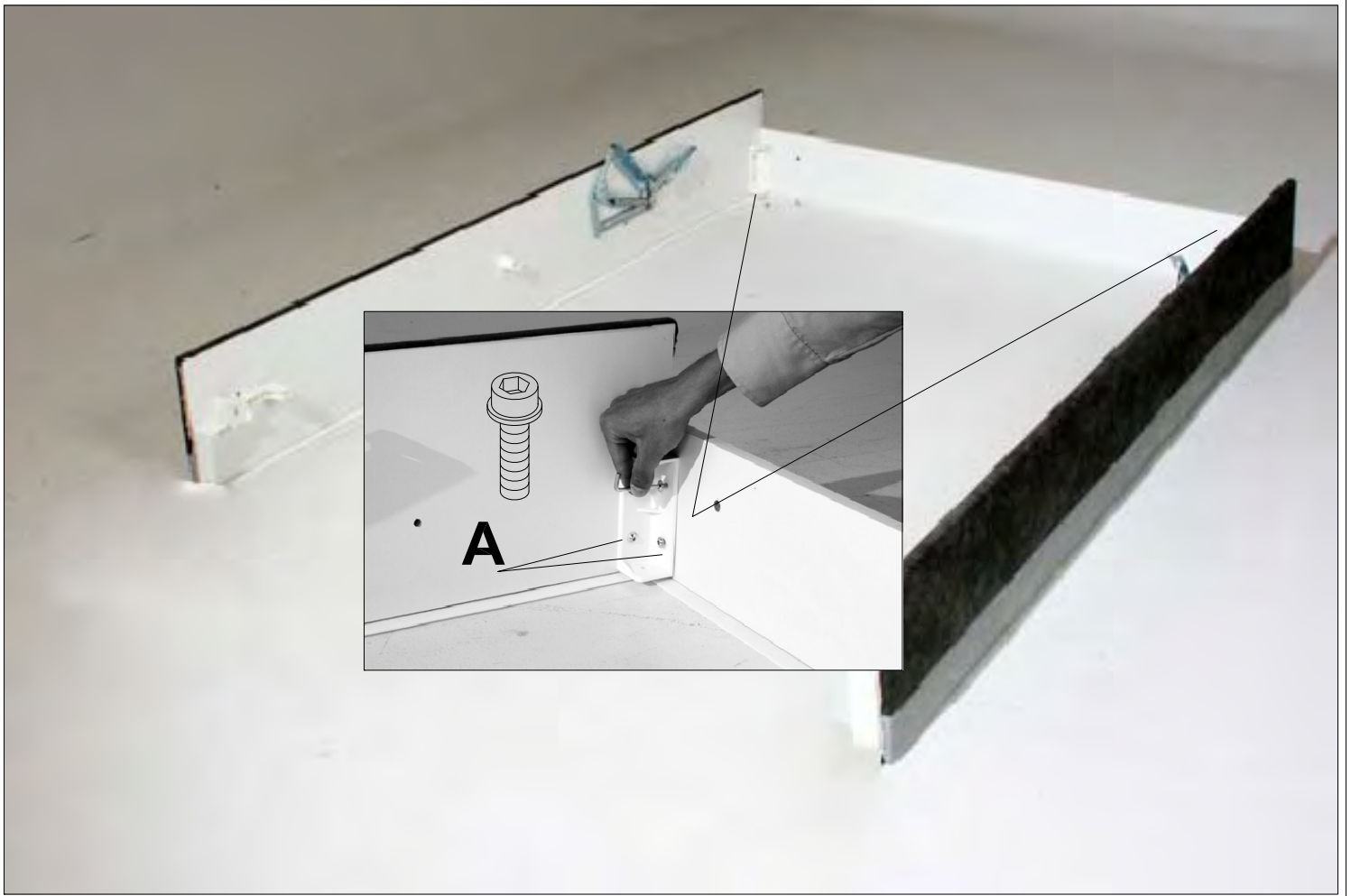

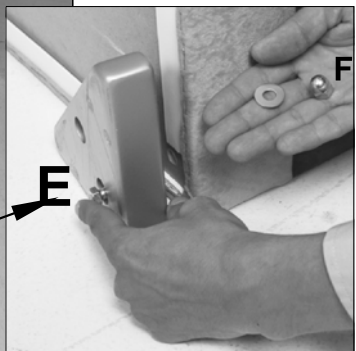
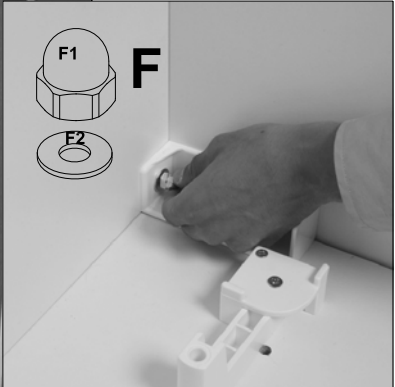
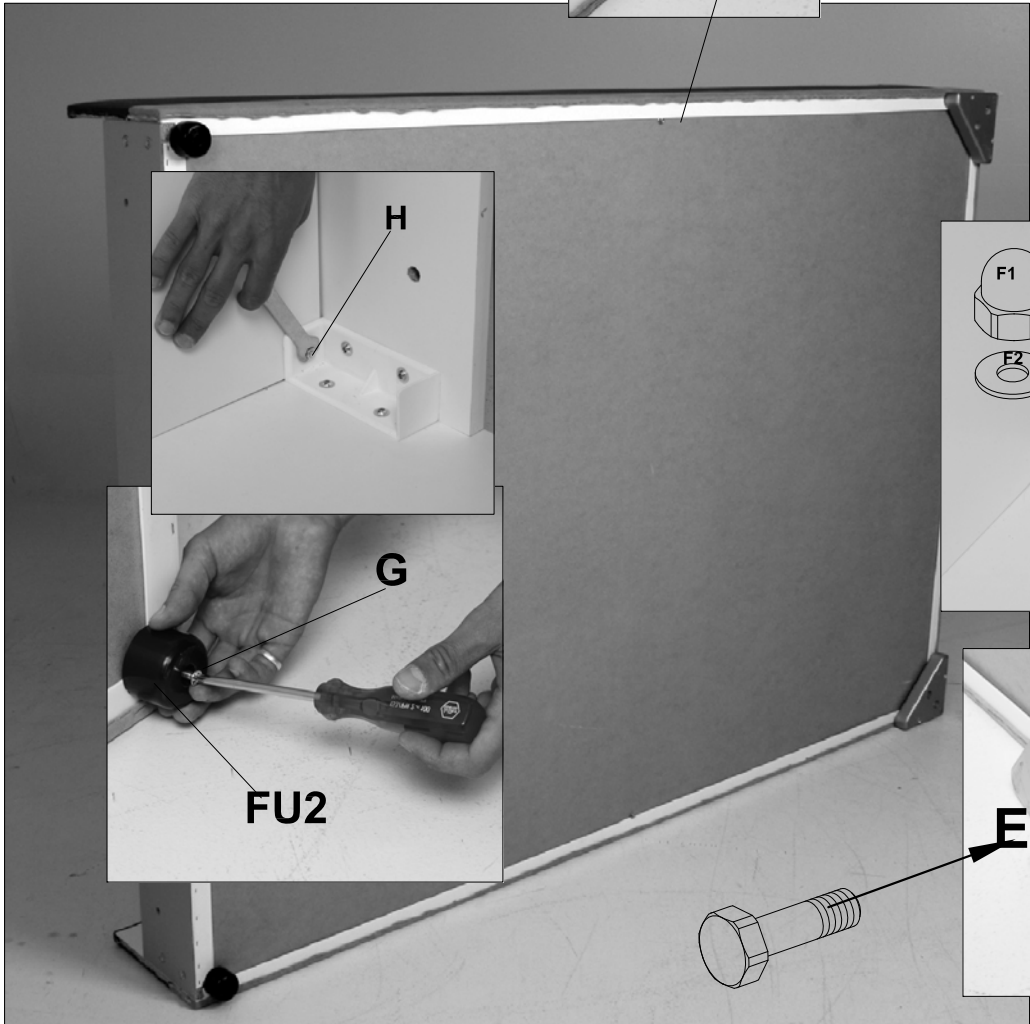
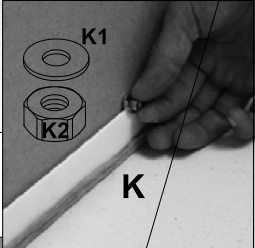

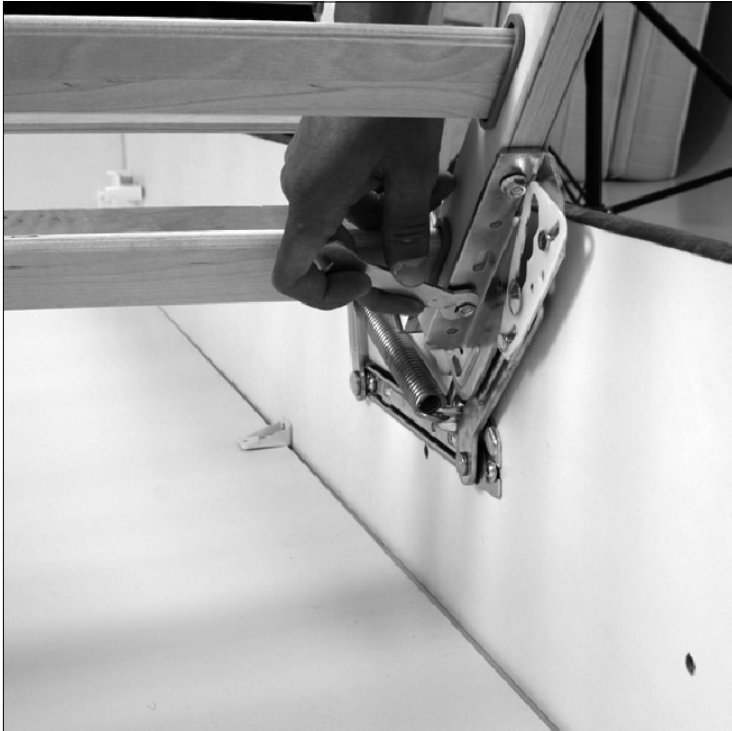

D Die Formen von Bauteilen können von dieser Zeichnung abweichen.

GB Shapes of individual parts may vary from drawing (foot end, head end, headboard, etc.)

PL Kształty elementów łózka mogą różnić się od tych przedstawionych na rysunku

TR Yapı parçalarının görünümleri çizimde görünenlerden farklı olabilir.

NL De vormen van de individuele bouwelementen kunnen van de tekening afwijken.

RU Формы конструктивных элементов могут отличаться от этого рисунка

I Le forme possono variare a secondo del modello dal disegno sottostante

F La forme des éléments peut diverger de cette illustration (piéd de lit, tête de lit, panneau arrière, etc.).

HU A bútor elemek formája eltérő lehet a rajzon szematikusan ábrázolt mintától.

CZ Rozměry a profil zobrazených elementů se mohou od tohoto výkresu odlišovat

RO Forma componentelor poate sa difere de aceasta schita

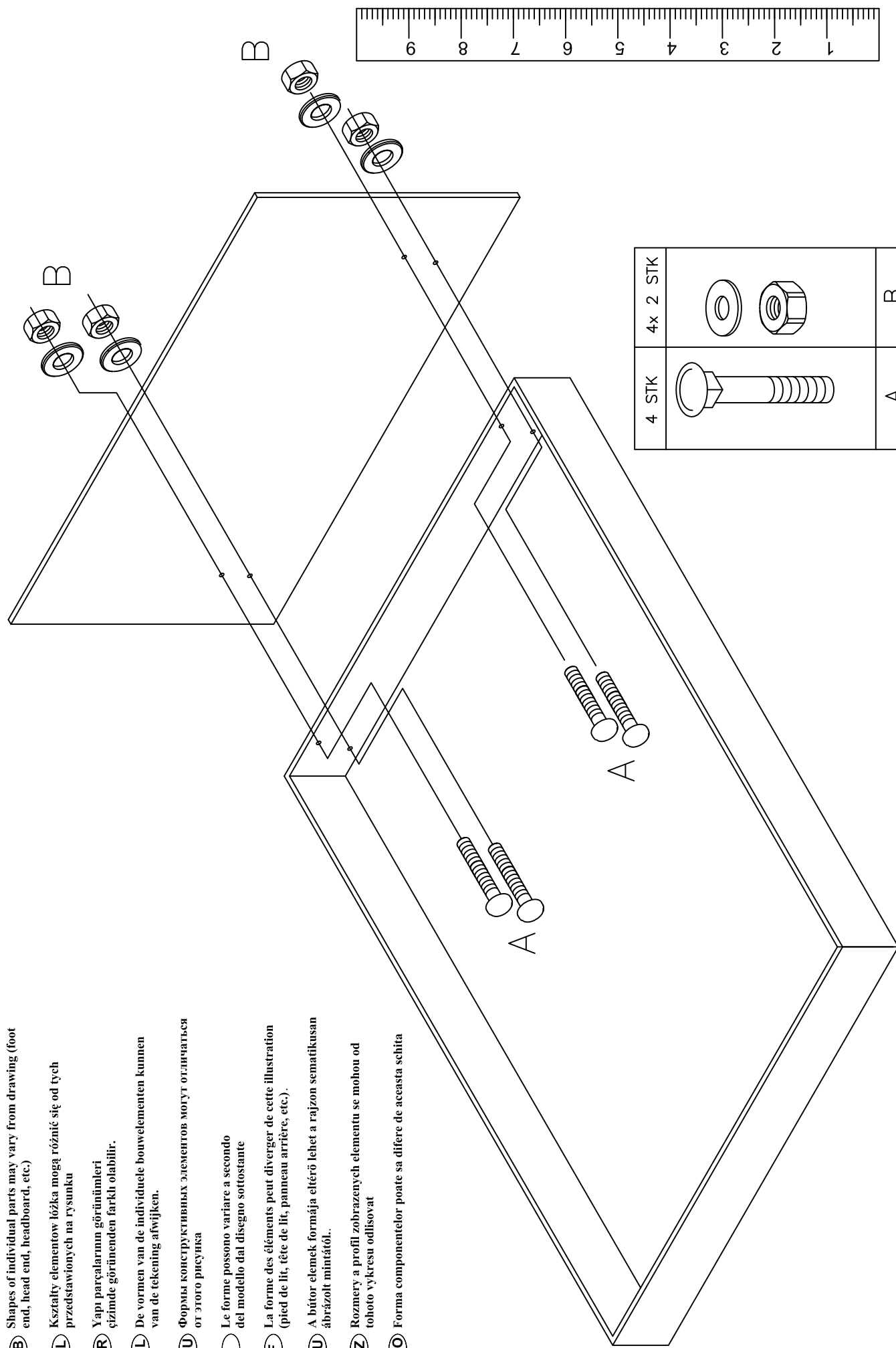

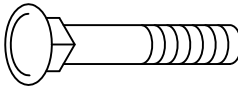
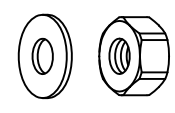
4 STK		A
4x 2 STK		B